

2020

LED PROFILE LED PROFILES



LED PROFILE PROFESSION - / LED PROFILES - TUTORIAL



LED Profile

LED profiles

Schritt für Schritt / Tutorial 1.01



LED Aufbauprofile

surface LED profiles

SLIM8 AC2/Z	2.01
SMART10 AC2/Z	2.05
SURFACE10 BC/UX	2.09
BEGTON12 J/S	2.13
UNI12 BCD/U	2.17
SURFACE14 EF/TY	2.21
SMART16 BC3/U4	2.25
LINEA20 EF/TY	2.29
WIDE24 G/W	2.41

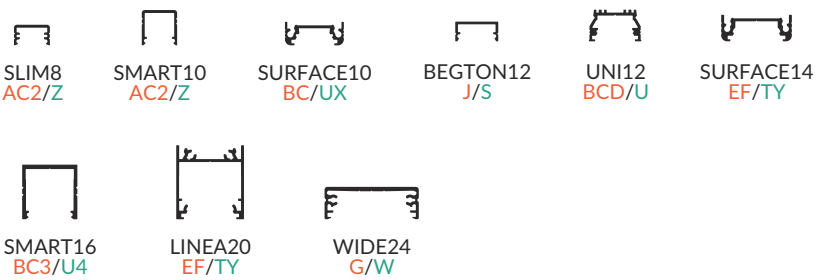

LED Einbauprofile

recessed LED profiles

FLAT8 H/UX	3.01
HI8 C1	3.05
SLASH8	3.09
DEEP10 BC/UX	3.13
GROOVE10 BC/UX	3.17
SMART-IN10 AC2/Z	3.21
BEGTIN12 J/S	3.25
FLOOR K	3.29
FLOOR8 K	3.31
FLOOR12 K/U	3.33
GROOVE14 EF/TY	3.35
SMART-IN16 BC3/U4	3.39
LINEA-IN20 EF/U7	3.43
LINEA-IN20 TRIMLESS EF/U7	3.51

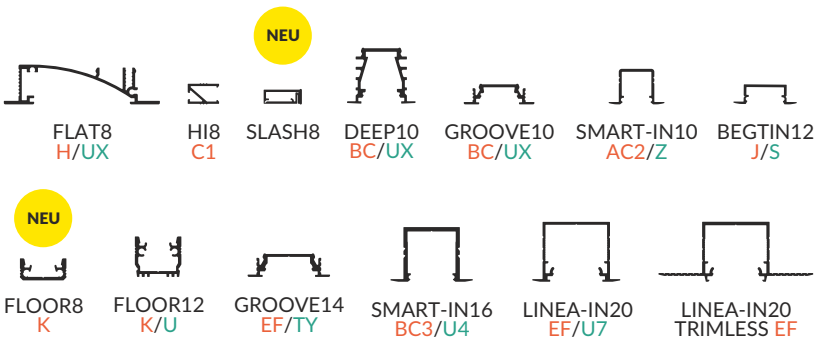

LED Eckprofile

corner LED profiles

TRIO10 BC	4.01
CORNER10 BC/UX	4.05
QUARTER10 BD/U6	4.09
CABI12 E	4.13
CORNER14 EF/TY	4.17
CORNER27 G/UX	4.21

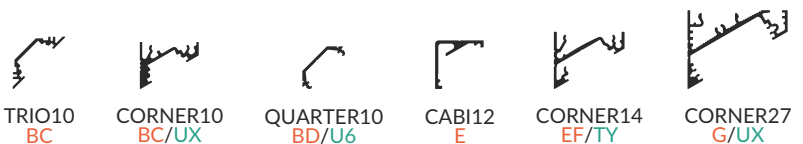

spezielle LED Profile

special application LED profiles

PEN8 I	5.01
BACK10 A/UX	5.05
STEP10 C	5.09
WAY10 C	5.13
ARC12 CD/U5	5.17
FIX12 / FIX16	5.21
WALLE12 BCD	5.23
PEN12 CJ	5.27
UNI-TILE12 C	5.31
FRAME14 BC/Q	5.37
OVAL20 BC	5.41

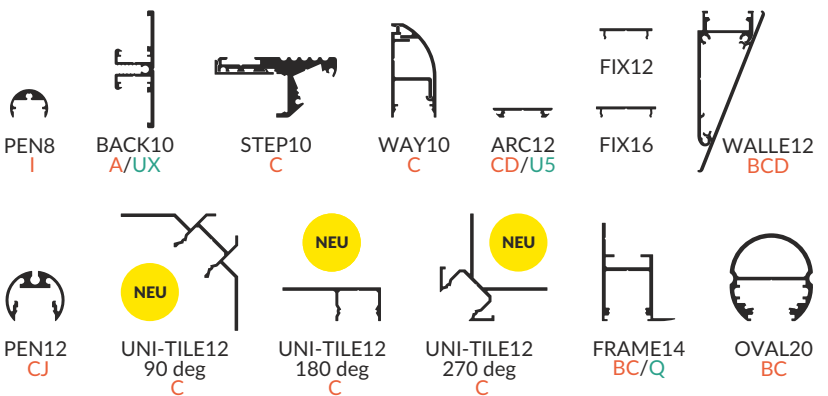

LED Glaskantenprofile

glass application LED profiles

TWIN8	6.01
MIKRO10	6.03
EDGE10 BC	6.05
MIKRO-LINE12 J	6.09



VARIO30

VARIO30-01	7.06
VARIO30-02	7.06
VARIO30-03	7.06
VARIO30-08	7.06

VARIO30-09	7.07
VARIO30-10	7.07
FIX16	7.07

VARIO30-04	7.14
VARIO30-05	7.14
VARIO30-06	7.14
VARIO30-07	7.14

AUFBAUPROFILE / SURFACE

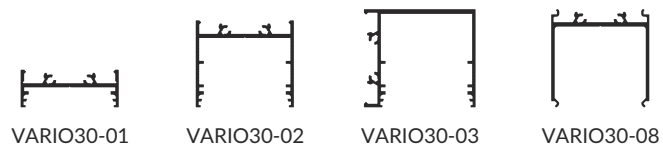

EINSPEISUNGSPROFIL POWER SUPPLY PROFILE

HILFSPROFILE ASSISTANT PROFILES

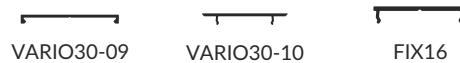

EINBAUPROFILE ZUM VERPUTZEN RECESSED - SPACKLE FLANGE MOUNTING

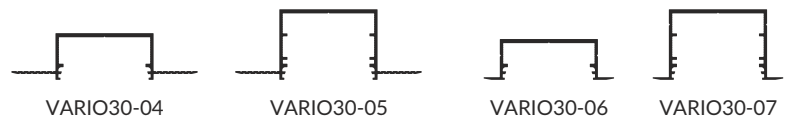

EINBAUPROFILE RECESSED

Große Profile big profiles

PHIL53	8.01
PHIL für Einbau / PHIL recessed	8.02
LOWI	8.02

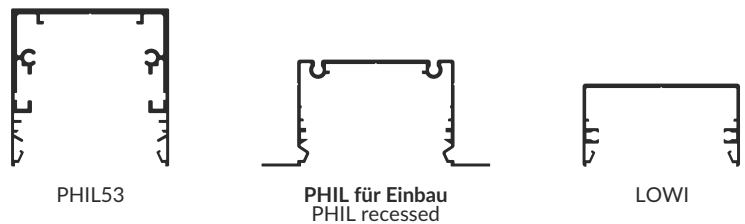

LED Zubehör

LED accessories

LED Streifen Serie PREMIUM 24 V / 24 V PREMIUM LED strips	9.01
LED Module Serie PREMIUM 24 V / 24 V PREMIUM LED modules	9.05
LED Lichtquelle 12 V / 12 V LED sources	9.06
LED Netzteile 24 V / 24 V LED power supplies	9.07
LED Netzteile 12 V / 12 V LED power supplies	9.08
die Gehäuse für Netzteile / power supply cases	9.09
Steuerungssensoren und Schalter / lighting controllers and switches	9.10
Vario white Beleuchtungssystem / Vario white lighting system	9.13
RGB Beleuchtungssystem / RGB lighting system	9.14
Kabel, Verlängerungskabel, Anschlüsse / cables, extensions, connectors	9.15
Abhängungen für die LED Profile / LED profile slings	9.16
Gelenkhalter für die LED Profile / tilted bracket for LED profiles	9.16
weiteres Zubehör / other accessories	9.17

allgemeine Informationen general information

Warum LED Profile? / Why LED profiles?	10.01
LED Technologie / LED technology	10.03

Verkaufsunterstützung sales support

Verkaufsunterstützung / Sales support	11.1
---------------------------------------	------

Typen der LED Profile von TOPMET / TOPMET profile categories



AUFBAUPROFILE / SURFACE

LED Profile mit der universellsten Anwendung. Die Montage auf einer flachen Oberfläche erfolgt am meisten mit Hilfe von Aluminium- oder flexiblen Stahlhaltern, aber auch mit Schrauben, Montagebänder. Bemerkenswert sind folgende Profile: SURFACE10, SURFACE14, LINEA20 - versteckte Befestigung.

LED profiles with the most universal applications. Installation on a flat surface, most commonly with the use of aluminium holders or steel flexible mounting plates but also with the use of screws, or assembly tapes. It is worth to note the profiles with hidden mounting: SURFACE10, SURFACE14 and LINEA20.

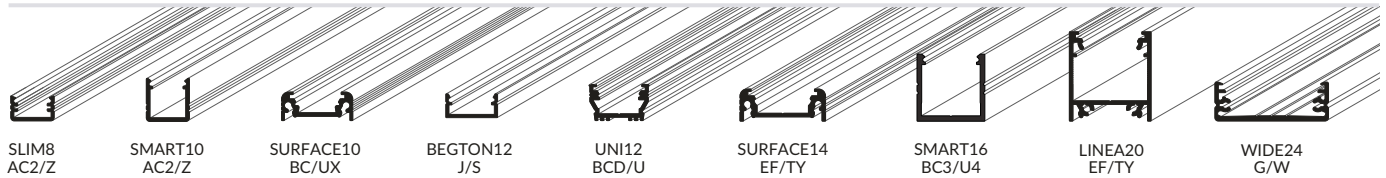

EINBAUPROFILE / RECESSED

Ein Vorteil des Einbauprofils ist das Erreichen von einer Lichtfläche, die nahezu mit der Oberfläche der Wand oder des Möbels zusammenpasst. Die Montage der Profile verlangt einer Vorbereitung der Oberfläche - das Ausschneiden einer länglichen Öffnung in einem Möbelstück (HI8, SLASH8, GROOVE10, BEGTIN12, GROOVE14), in einer Rigipsplatte (FLAT8, DEEP10) oder die Abstandbildung bei dem Auslegen von Fliesen (FLOOR8, FLOOR12).

The advantage of recessing a profile is obtaining an illuminating surface which almost levels with the plane of the wall or furniture. Profile installation requires surface preparation - cutting a longitudinal opening in the furniture (HI8, SLASH8, GROOVE10, BEGTIN12, GROOVE14), a plasterboard (FLAT8, DEEP10) or leaving an appropriate distance when installing the tiles (FLOOR8, FLOOR12).

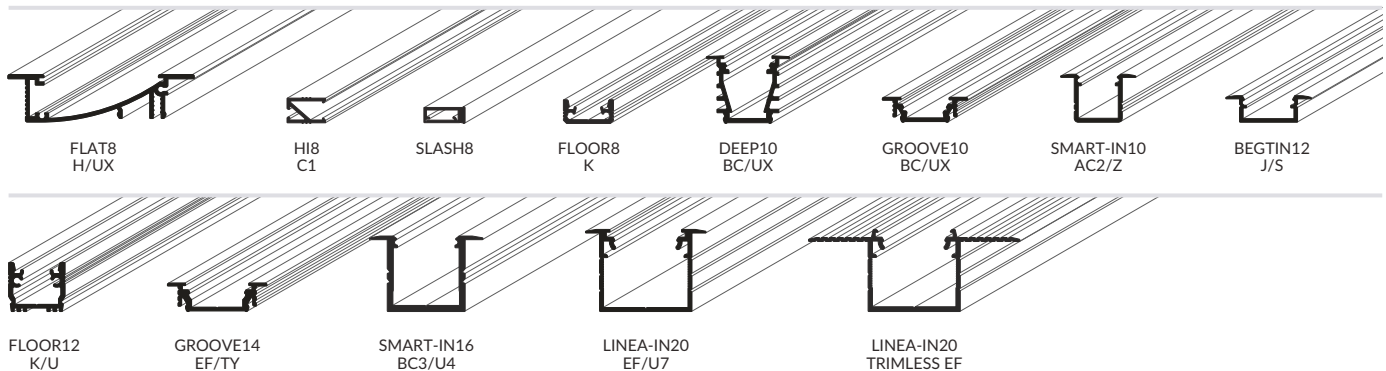

ECKPROFILE / CORNER

Für die Anwendung in den Wand-, Möbel- und Vitrinenecken. Die Montage mit Hilfe von Haltern, Schrauben, Montageband. Von Vorteil in den Profilen CORNER10, CORNER14 und CORNER27 ist die versteckte Befestigung. Die Profile ermöglichen einen Lichtwinkel von 30° oder 60° gegenüber der Montagefläche. Das Profil CABI12 wurde für Glasvitrinen entworfen, Montage mit Klebstoff. Es ermöglicht die Blendung zu vermeiden. Die Montage unter einem Winkel von 30° oder 60°. Dank einem symmetrischen Durchschnitt kann man die Profile an den Ecken unter dem Winkel von 90° zusammenbinden. TRIO10, QUARTER10 - geeignet für die Beleuchtung unter dem Winkel von 45°.

To be used in the corners of wall, furniture and cabinets. Installation with mounting plates, screws, assembly tape. The asset of the CORNER10, CORNER14 and CORNER27 collections is the hidden mounting. These profiles provide a possibility to direct the light at an angle of 30° or 60° to the assembly plane. The CABI12 profile is designed for glass cabinets, then adhesive mounted. It allows to avoid glare. Installation at an angle of 30° or 60°. Thanks to the symmetric cross-section, the profiles can be joined in the corners at an angle of 90°. TRIO10, QUARTER10 - for lighting at an angle of 45°.





SPEZIELLE PROFILE / SPECIAL APPLICATION

Eine Gruppe von Profilen mit breiten Anwendungsmöglichkeiten: Wand-, Decken-, Treppen-, Garderobenprofile oder architektonische Profile. Entworfen für Spezialanwendungen.

Unter den Profilen befindet sich das Profil PEN8 mit der größten Zahl von Montagehaltern (u.a. Ausleger, Dübelhalter, flache und einfache Halter) zum Bilden von einer Reihe von Variationen und zum Erreichen von bestimmten Lichteffekten.

A group of profiles with a broad application spectrum - for the ceiling, wall, architectonic, stair, wardrobe. Designed for special applications. Among them, the PEN8 with the highest number of holders (i.a.: extension arms, flat, simple and stretcher holders) for creating a number of combinations and achieving the defined illumination effects.

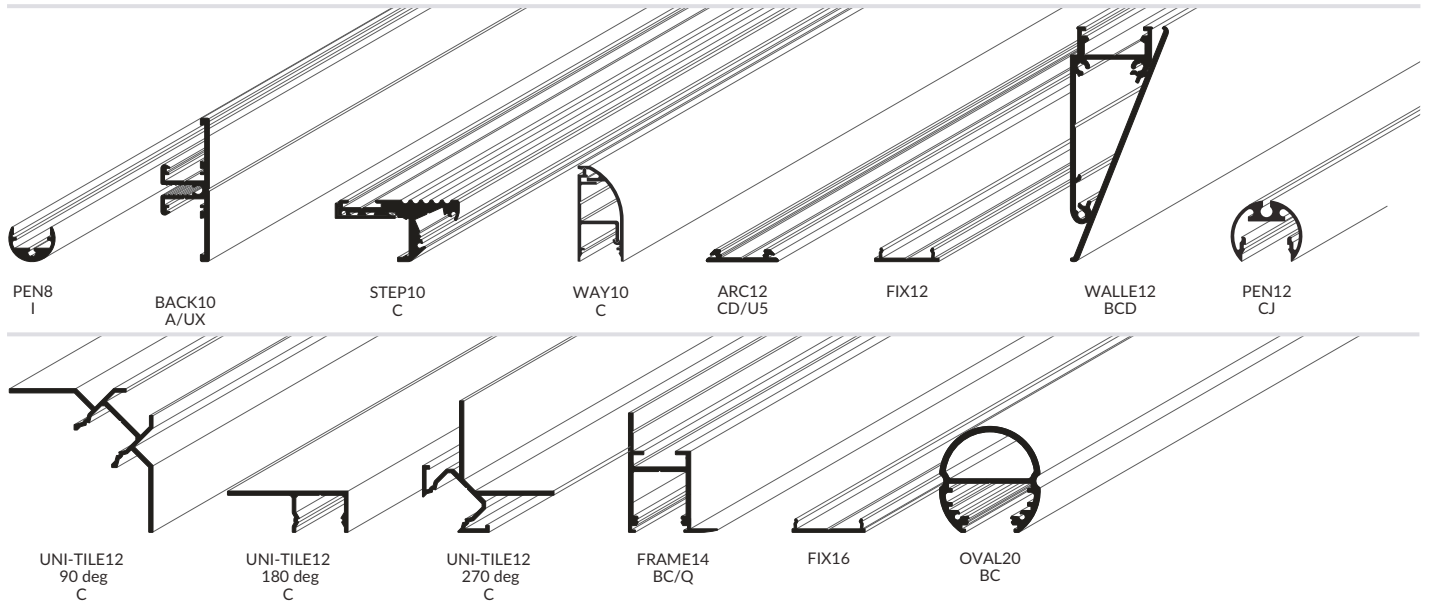

GLASKANTENPROFILE / GLASS APPLICATION

Die Glaskantenprofile dienen zur Präsentation von Gegenständen in den Vitrinen, erleuchten eine sandgestrahlte Werbegrafik oder dekorative Grafik. Montage auf der Kante einer Glasscheibe, die Profile dienen nicht als ein Konstruktionsteil zum Halten des Bretts. EDGE10 - im Gegenteil zu den anderen - wird das Profil auf die Vorderseite des Bretts gelegt, was eine bessere Beleuchtung von dem Ausstellungsstück unten oder über dem Brett ermöglicht (nach der Drehung des Profils um 180°).

Profiles for glass are used to exhibit objects in cabinets and to illuminate the sanded advertising or decorative graphics. Installed on the edge of the glass panel, they do not constitute a shelf supporting structure. EDGE10 - in contrast to the other ones - is applied on the face of the shelf, which allows to better light up the exhibits under the shelf or above it (after rotating the profile by 180°).



**Was sagt uns die Name des Profils?
What does a profile name indicate?**

SURFACE10 BC/UX

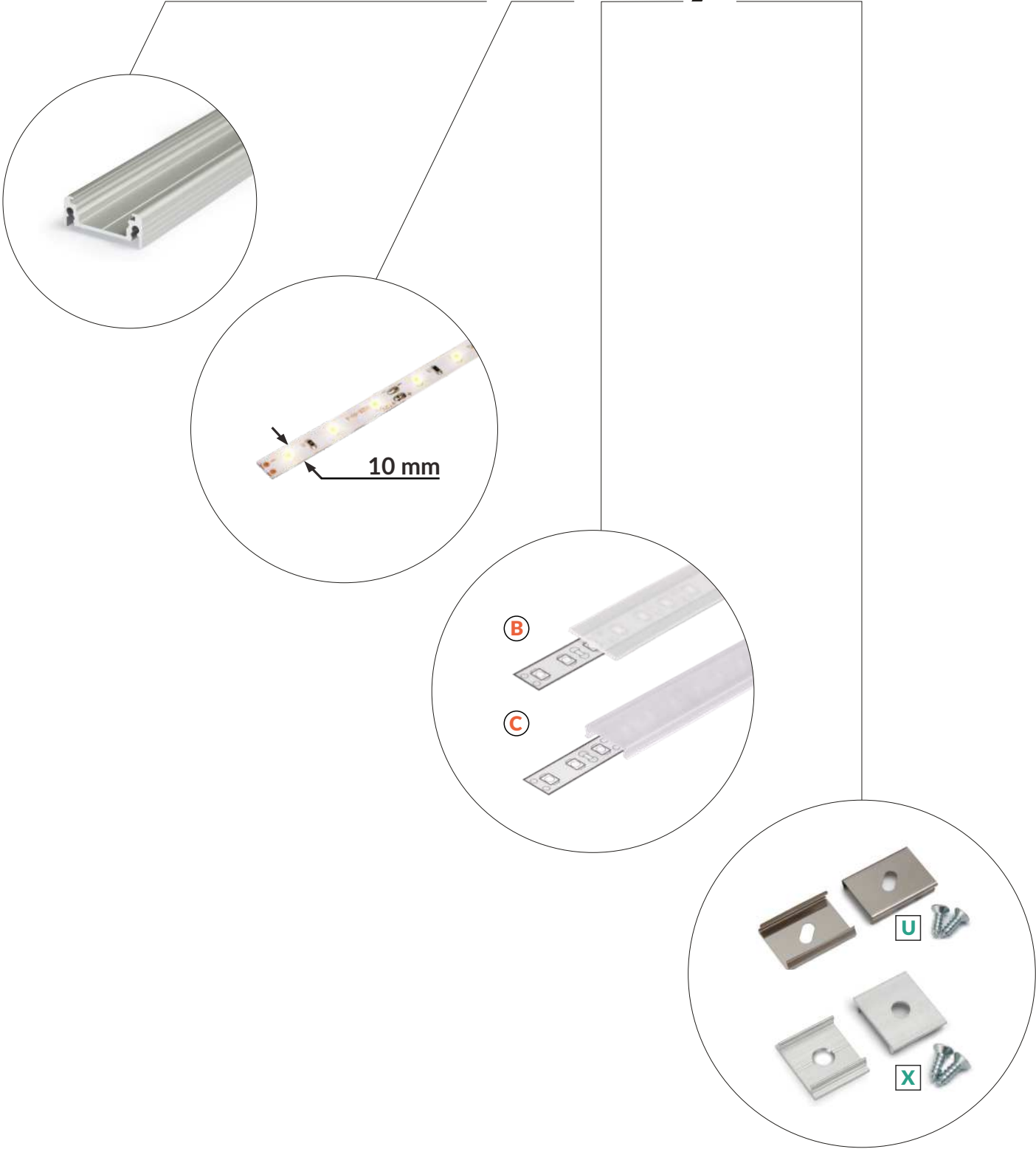

Slick

In unserem Sortiment haben wir auch LED Profile mit einem Slick Befestigungssockel. Diese Funktion ermöglicht ein einfaches Einclippen oder Einschieben der Abdeckung.

We also have profiles with the Slick socket in our assortment. This feature allows to click in or slide in the cover.

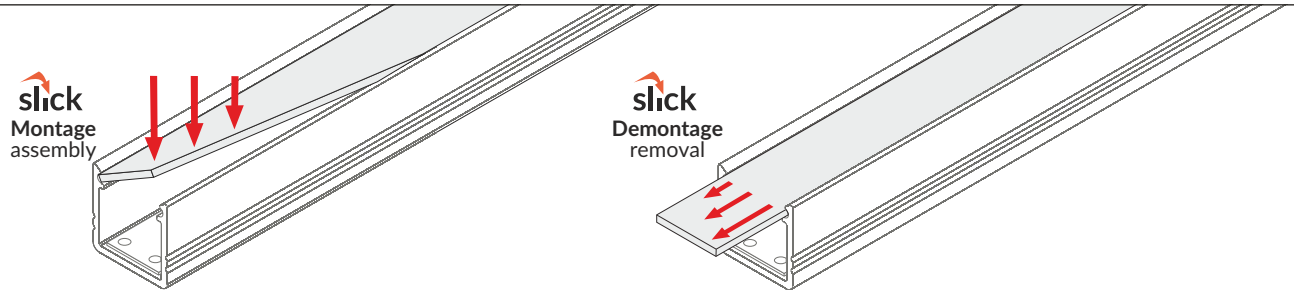

Unten befinden sich die Profile mit der Slick Funktion:
Profiles with Slick socket:

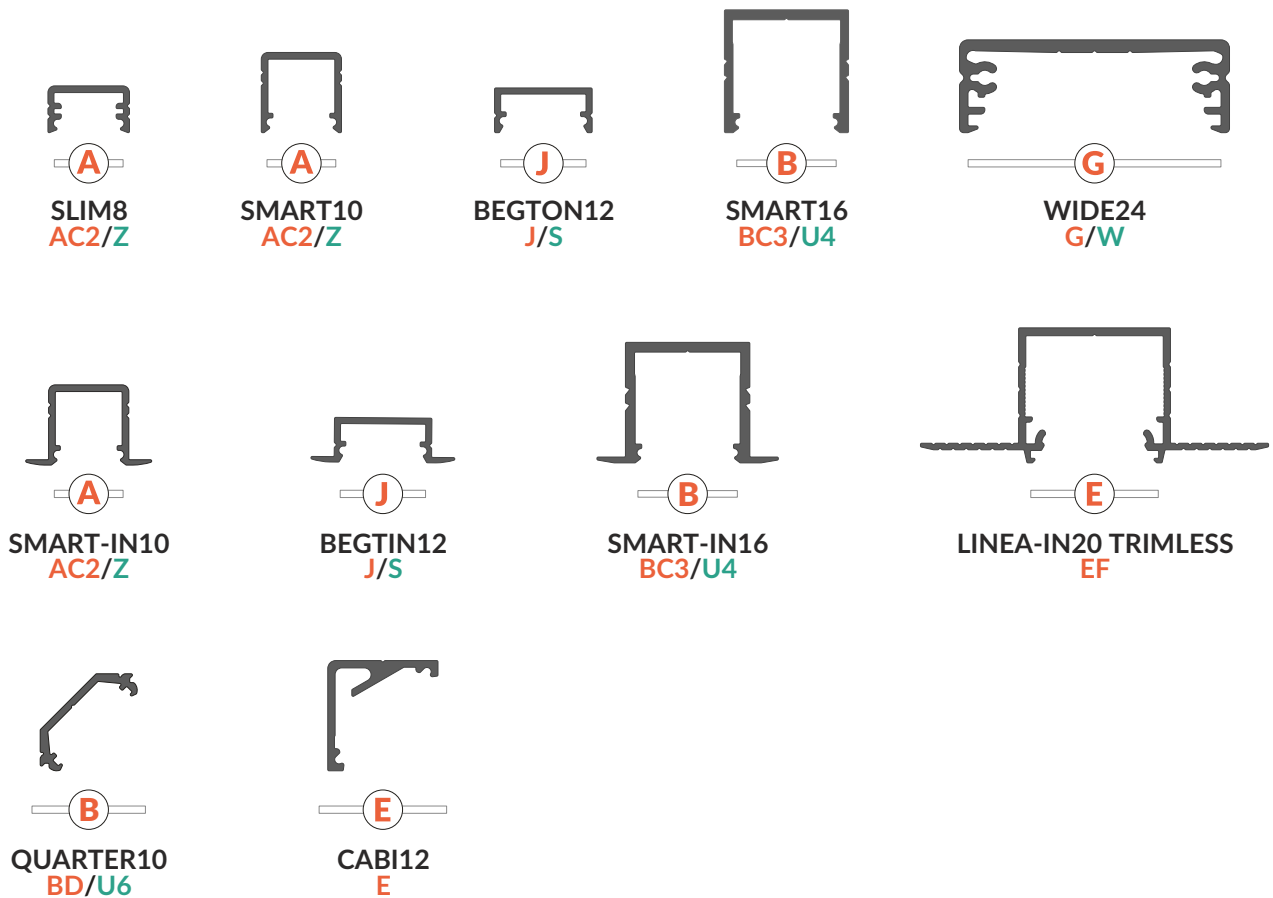

Wie wählt man die Abdeckung? / How to select a cover?

Die Abdeckungen für die LED Profile unterscheiden sich mit dem Grad der Lichtdurchlässigkeit. Eine bewusste Wahl ermöglicht besser das Lichteffect, die Lichtzerstreuung und Lichtverteilung einzuplanen. Die transparente Abdeckung nimmt am wenigsten Licht auf, danach ist die satinierte und opale Abdeckung.

Covers for aluminium LED profiles differ in the degree of transparency. Thanks to a conscious choice, you can plan the lighting effect, light dispersion and distribution better. A transparent cover absorbs a smaller amount of light, followed by frosted and opal ones.

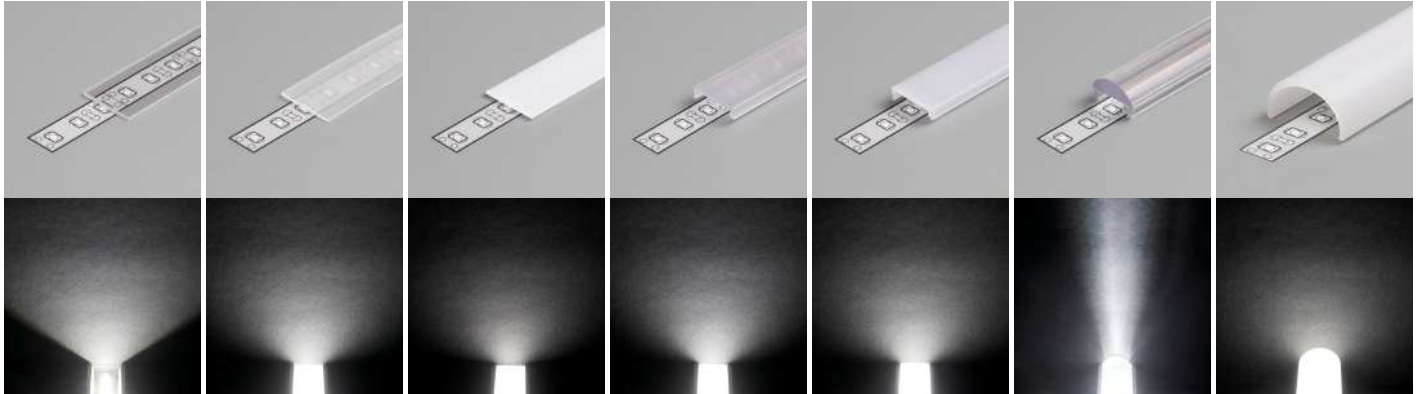

B einschiebbar transparent
B slide transparent

B einschiebbar satiniert
B slide frosted

B einschiebbar opal
B slide opal

C einclipsbar transparent
C click transparent

C einclipsbar opal
C click opal

C click lens
C klik soczewka

D einclipsbar opal
D click opal

SPEZIALABDECKUNGEN

Es ist auch wert, sich mit interessanten Lichteffecten vertraut zu machen, die mehr spezialistische Abdeckungen ergeben.

SPECIAL COVERS

Familiarise yourself with the interesting lighting effects provided by more specialised diffusers.

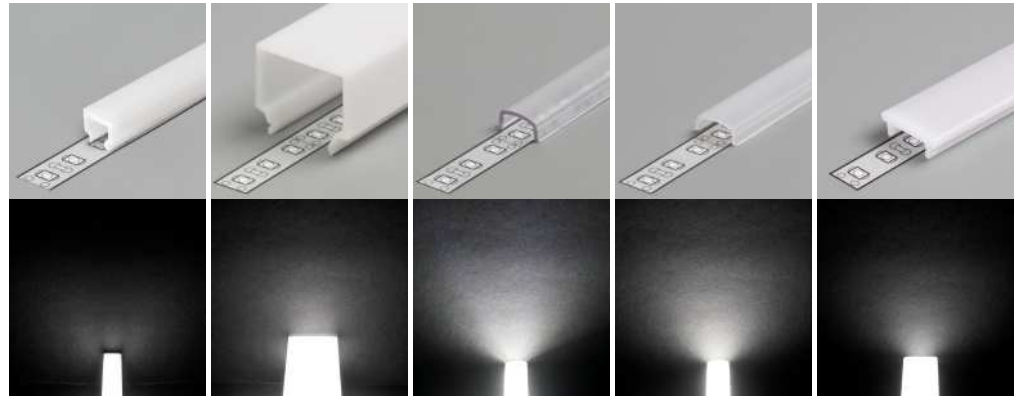

C1 einclipsbar opal
C1 click opal

H18 _____>3.05

E7 einclipsbar opal
E7 click opal

LINEA20 _____>2.29
LINEA-IN20 _____>3.43
LINEA-IN20 _____>3.51
TRIMLESS
SURFACE14 _____>2.21
GROOVE14 _____>3.35
CORNER14 _____>4.17

I einclipsbar satiniert
I click frosted

PEN8 _____>5.01

I einclipsbar opal
I click opal

PEN8 _____>5.01

K einclipsbar opal
K click opal

FLOOR8 _____>3.31
FLOOR12 _____>3.33

Dadurch ist auch die Sichtbarkeit von LEDs unterschiedlich. Wenn man in einigen Profilen opale Abdeckungen und ein LED Streifen mit 120 LEDs anwendet, gibt es den Effekt einer homogenen Lichtlinie.

It also means a different degree of visibility of LED points. Opal covers in some profiles, in conjunction with a 120 P/m tape, allow to achieve the effect of a continuous line of light.

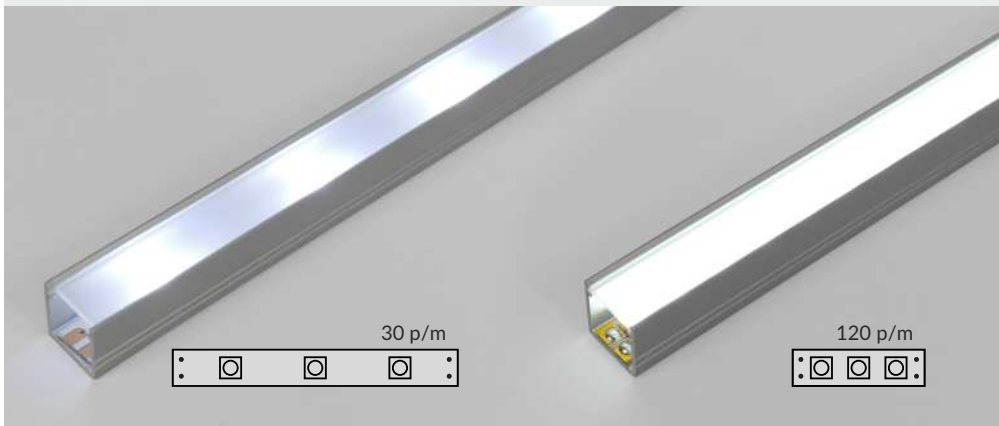

Hinweis / Tip:

Wenn wir homogene Lichtlinie in einem flachen Profil erzielen möchten, empfiehlt sich die Verwendung eines sehr dichten LED Streifens mit 240 Punkten / m. Siehe > 9.03

If we want to obtain a continuous line of light with a shallow profile, it is worth to use a very dense LED strip 240 P/m. See > 9.03

Die Abdeckungen unterscheiden sich auch durch die Art und Weise der Montage

ABDECKUNG ZUM EINSCHIEBEN (Bezeichnung: A, B, E, G, H, J)

Es ist ein Streifen aus Kunststoff mit drei unterschiedlichen Graden der Lichtdurchlässigkeit. Man soll die Abdeckung vom Anfang des Profils einschieben und entlang des markierten Sockels ziehen oder in die Slick Befestigungssockel einclippen.

ABDECKUNG ZUM EINCLIPSEN (Bezeichnung: C, C1, C2, C3, D, E7, F, I, K)

Die Montage und Demontage der Abdeckung ist bequemer. Der Zugang zu den Enden des Profils ist nicht notwendig, was das Einclippen der Abdeckung sogar nach der Montage des Profils in einer Nische oder einem Möbelstück ermöglicht.

The covers also differ in the method of assembly.

SLIDE COVER (labelling: A, B, E, G, H, J)

It is a strip of plastic available in 3 different degrees of transparency. It needs to be slid from the beginning of the profile and dragged along the marked socket or clicked in the Slick socket.

CLICK COVER (labelling: C, C1, C2, C3, D, E7, F, I, K)

Its assembly and removal are more convenient. Access to the ends of the profile is not necessary, which allows to click in the cover even after installing the profile in a recess or a piece of furniture.

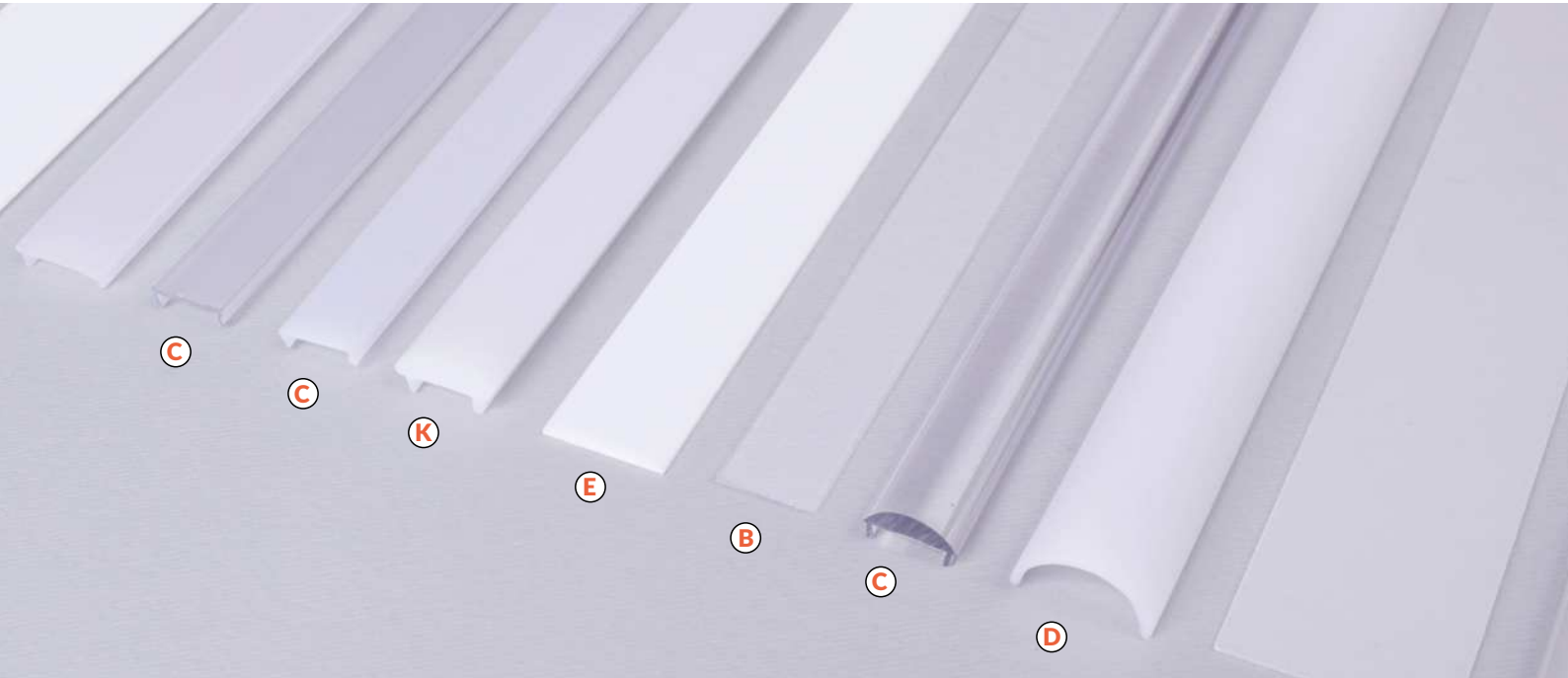

Viele von den Abdeckungen aus dem TOPMET Angebot gelten als kompatibles Zubehör. Es bedeutet, dass die selbe Abdeckung mit mehreren Profilen zusammenpasst.

Bei dem richtigen Anpassen der Abdeckungen helfen die Buchstaben. Dementsprechend passen z. B. mit dem LED Profil SURFACE10 BC/UC folgende Abdeckungen zusammen:

- B zum Einschieben
- C zum Einclippen
- C Linse

Die Abdeckung C zum Einclippen passt wiederum mit folgenden Profilen zusammen:

- SURFACE10 BC/UX
- UNI12 BCD/U
- GROOVE10 BC/UX
- DEEP10 BC/UX
- TRIO10 BC
- CORNER10 BC/UX
- STEP10 C
- WAY10 C
- WALLE12 CD
- ARC12 CD/U5
- PEN12 CJ
- UNI-TILE12 C
- FRAME14 BC/Q
- OVAL20 BC
- EDGE10 BC

Many of the covers in the TOPMET offer are system accessories. It means that one cover fits a few, different profiles.

A letter describing the socket helps correct matching. And so, e.g., the SURFACE10 BC/UX profile can be fitted with the covers:

- B slide
- C click
- C lens

Cover C click, on the other hands, fits the profiles:

- SURFACE10 BC/UX
- UNI12 BCD/U
- GROOVE10 BC/UX
- DEEP10 BC/UX
- TRIO10 BC
- CORNER10 BC/UX
- STEP10 C
- WAY10 C
- WALLE12 C
- ARC12 CD/U5
- PEN12 CJ
- UNI-TILE12 C
- FRAME14 BC/Q
- OVAL20 BC
- EDGE10 BC

Rolle 20 m / 20 m reel

Lange Lichtlinien ohne Spalten. Minimalisieren von Abfallabschnitten.

Für Abdeckungen C und F einclipsbar opal führen wir 20 m lange Abschnitte in Rollen ein und in ein bequemes Karton verpackt.

Long lines of light without connection gaps. Minimizing cutting waste.

For C and F click opal covers we introduce 20metre long lengths, rolled up on a reel, packed in a convenient cartonbox.



C2 einclipsbar / click

Abdeckungen einclipsbar für Profile:
Click covers for profiles:

SLIM8
SMART10
SMART-IN10

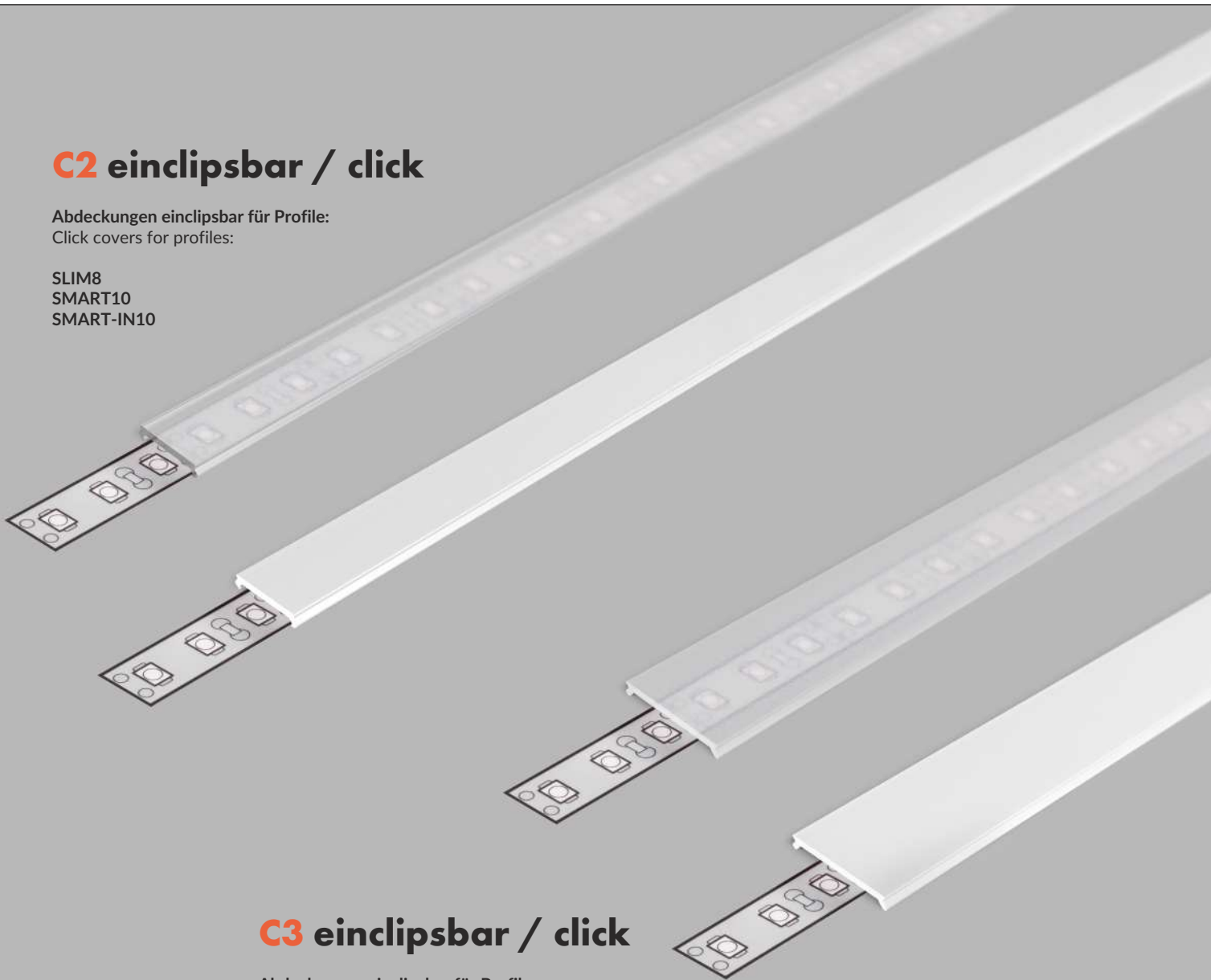

C3 einclipsbar / click

Abdeckungen einclipsbar für Profile:
Click covers for profiles:

SMART16
SMART-IN16

Abdeckungen / Covers

Die von TOPMET angebotenen Abdeckungen unterscheiden sich untereinander nicht nur mit dem Lichteffect, sondern auch mit den technischen Parametern. Innerhalb den Spezialabdeckungen zeichnet sich besonders eine Abdeckung aus - die für Profile LED FLOOR8 und FLOOR12 bestimmt ist, d.h. die Abdeckung K opal. Ihr charakteristisches Merkmal ist eine hohe Beständigkeit gegen Beschädigungen und Schlagbeständigkeit von IK08. Dies ermöglicht das Betreten der Abdeckung ohne Angst, dass es zerspringt oder zerkratzt wird.

The covers in the TOPMET offer differ between one another not only in terms of the achieved lighting effect but also in terms of technical parameters. Among the special cover, one stands out in particular - designed for the FLOOR8 and FLOOR12 LED profiles, the K opal cover. Its characteristic feature is the high resistance to damage and impacts with a degree of IK 08. This is why it is possible to tread over it - without having to worry about cracking or scratching.

Die Art der Abdeckung cover type	Das Material material	Die Anwendungstemperatur work temperature		UV- Beständigkeit UV resistance	Das Zertifikat für Brennbarkeit nach PN-EN 60695-2-11 fire hazard certificate according to IEC 60695-2-11	Lichtdurch- lässigkeit transparency	Lichtst- reuungsfaktor coefficient diffusion
		min [°C]	max [°C]				
(A) (B) (E) (G) (H) (J) transparent transparent	PC	-50	100	✓	✓	93%	niedrig low
(A) (B) (E) (G) (H) (J) satinert frosted	PP	-15	85	✓	✓	90%	niedrig low
(A) (B) (E) (G) (H) (J) opal opal	PP	-15	85	✓	✓	70%	hoch high
(C) (F) transparent transparent	PMMA	-20	70	✓	✓	93%	niedrig low
(C) (F) opal opal	PMMA	-20	70	✓	✓	75%	niedrig low
(C) Linse lens	PC	-50	100	✓	✓	90%	niedrig low
(C1) opal opal	PMMA	-20	70	✓	✓	70%	hoch high
(C2) (C3) transparent transparent	PMMA	-25	120	✓	✓	93%	niedrig low
(C2) (C3) opal opal	PMMA	-25	120	✓	✓	75%	niedrig low
(D) opal opal	PMMA	-20	70	✓	✓	70%	hoch high
(E7) opal opal	PMMA	-20	70	✓	✓	70%	hoch high
(I) satinert frosted	PC	-50	100	✓	✓	90%	niedrig low
(I) opal opal	PC	-50	100	✓	✓	80%	mittler medium
(K) opal opal	PC	-50	100	✓	✓	60%	hoch high

Toleranz / Tolerance

Wir sind darum sehr bemüht, dass eine maximale Wiederholbarkeit unserer Produkte eingehalten wird. Trotzdem können zwischen den jeweiligen Partien geringfügige Unterschiede vorkommen, die auf die Spezifik des Herstellungsverfahrens zurückzuführen sind. Deswegen empfehlen wir immer die vorliegenden Toleranzen zu berücksichtigen.

We make every effort to maintain maximum repeatability of our products. Despite this, there may be small differences between the individual batches due to the nature of the manufacturing processes. That is why we always recommend considering the following tolerances.

LÄNGE	
Standardmäßige Toleranz	
PROFILE	+20 mm
ABDECKUNG	+20 mm
Mögliche Mindesttoleranz	
PROFILE	+0,5 mm
ABDECKUNG	+0,5 mm

Achtung. Die Vorbereitung eines Produktes mit einer anderen Toleranz als die standardmäßige erhöht die Kosten, verlängert die Verarbeitungszeit und verlangt einer Angabe der gewünschten Toleranz bei dem Aufgeben einer Bestellung.
Produkte werden bei der Temperatur von 20°C geschnitten.

LENGTH	
Standard tolerance	
PROFILES	+20 mm
COVERS	+20 mm
Minimal tolerance	
PROFILES	+0,5 mm
COVERS	+0,5 mm

Note. The preparation of products with non-standard tolerance increases costs, extends lead time and requires indication of the desired tolerance in the order.
Cutting of the products is carried out at a temperature of 20°C.

TEMPERATURDEHNUNG	
Der Wert ist für den Unterschied von 10°C pro Laufmeter angegeben	
PROFILE	bis zu ~0,2 mm
ABDECKUNG	C10 NARROW: bis zu 0,7 mm
	C10 WIDE: bis zu 0,7 mm
	C10 OPAL: bis zu 0,8 mm
	sonstige: 0,2~0,3 mm

TEMPERATURE EXPANSION	
Value stated for the difference of 10°C, per linear metre	
PROFILES	up to ~0,2 mm
COVERS	C10 NARROW: up to 0,7 mm
	C10 WIDE: up to 0,7 mm
	C10 OPAL: up to 0,8 mm
	others: up to 0,2~0,3 mm

DURCHMESSER	
Alle angegebenen Profile unterliegen der Toleranz gemäß der Norm PN-EN 755-9.	

DIMENSIONS OF CROSS SECTION	
For all provided profile dimensions we apply tolerances in accordance with PN-EN 755-9.	

FARBE	
ELOXIERTER OBERFLÄCHEN	silbern: C-0
	schwarz: C-35
LACKIERTE OBERFLÄCHEN (anhand der RAL Palette)	weiß: RAL 9003 matt
	schwarz: RAL 9005 matt

COLOUR	
ANODIZED SURFACES	silver: C-0
	black: C-35
PAINTED SURFACES (according to the RAL palette)	white: RAL 9003 mat
	black: RAL 9005 mat

Montagezubehör / Mounting accessories

KOMPATIBLES ZUBEHÖR - passt mit vielen unterschiedlichen Profilen zusammen.

SPEZIELLES ZUBEHÖR - angepasst an einen Profiltyp, in der Regel dient es einer bestimmten Art und Weise der Montage: zum Aufhängen, auf einem Ausleger, unter einem Winkel usw.

SYSTEM ACCESSORIES - fit many different profiles.

DEDICATED ACCESSORIES - matched to one profile, are usually used for a more precise assembly method: pendant, on an extension arm, at an angle, etc.

MONTAGEHALTER / MOUNTING PLATES, HOLDERS

flexibel / flexible

aus Aluminium / aluminium

einfach - für eine senkrechte Montage in der Möbelplatte (in einem Schrank)
simple - for perpendicular assembly in a furniture board (cabinets)



konische oder längliche Öffnung?
„cone” or „slot”?

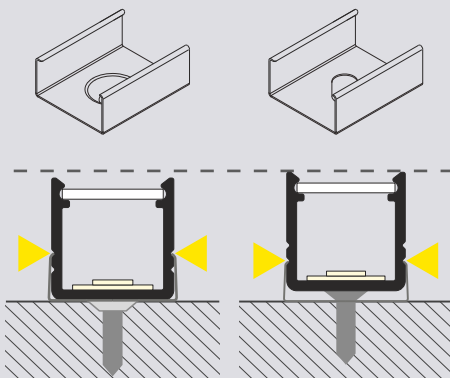

AUSLEGER / EXTENSION ARMS



Doppelausleger für OVAL20
OVAL20 double extension arm



Doppelhalter mit Gewinde für PEN8
PEN8 double holder with thread



Gelenkhalter mit Deckenhalter für PEN8
PEN8 jointed holder with soffit ceiling

VERBINDUNGSTÜCKE / CONNECTORS

Eine einfache Art und Weise der Verbindung von zwei Profilen in einer Linie oder mit einem bestimmten Winkel.
Easy method of joining 2 profile sections in a straight line or at a defined angle.



Verbindungsstück X 180 Grad
X connector 180 deg



Verbinder 90 Grad für SURFACE10
SURFACE10 connector 90 deg



Verbindungsstücke für LINEA20
LINEA20 connectors:



Verbindungsstück T 180 Grad
T connector 180 deg



Verbinder 90 Grad für GROOVE10
GROOVE10 connector 90 deg

Verbindungsstücke für LINEA20 gebogen
LINEA20 bent connectors:

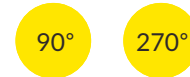

Verbinder 90 Grad für CORNER10
CORNER10 connector 90 deg

ABHÄNGUNGEN / SLINGS

Es ermöglicht den Bau von Pendelleuchten. Besonders empfohlen sind sie für das LED Profil LINEA20 (s. Seite 2.29-2.40), aber sie sind auch mit der Mehrheit der Profile kompatibel.
They enable creating pendant luminaires. They are especially recommended for the LED LINEA 20 profile (see pages 2.29-2.40) but are also compatible with most of the profiles.

MAX
50 V



Abhängung SELV 50 V 1500
SELV sling 50 V 1500



Abhängung für LED Profil-Halter 1500
sling for LED mounting 1500



Endkappen / Endings

Die Endkappen erfüllen die Funktion einer ansprechender Beendigung des Profils und eines zusätzlichen Schutzes der LED Lichtquelle. Die Endkappen sind in vier Grundfarben zugänglich: silbern, weiß, schwarz und grau. Die gewählten Endkappen für die Profile für Glasscheiben sind in einer transparenten Ausführung zugänglich, und die Endkappen für die Abdeckungen in einer opalen Ausführung. Der Kunststoff, der für die Produktion von den Endkappen verwendet wird erfüllt die Feuerbeständigkeitsnorm zur Beleuchtung Nummer: PN-EN 60695-2-11. Das Material: ABS, PC.

The endings, with the aim to aesthetically close the profile and additionally protect the LED source, come in four basic colours: silver, white, black and grey. The endings selected for the profiles for glass are available in transparent colour. Covers endings are available in opal colour. The material used for the production of the endings meets the lighting non-combustibility standard no.: PN-EN 60695-2-11. Material: ABS, PC.

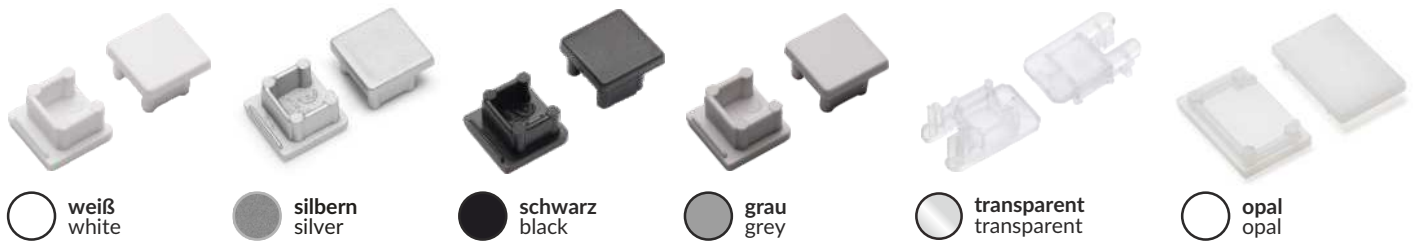

Die Endkappen mit oder ohne Öffnung - welche wählt man? Viele von unseren Endkappen sind in zwei Versionen zugänglich: Endings with a hole or without it - which one to choose? Some of our endings come in two versions:



Mit der Öffnung: ermöglichen ein ästhetisches Durchführen des Kabels ohne in der Endkappe oder in dem Profil bohren zu müssen.

With a hole: they allow aesthetic outlet for a cable without the need to drill through the ending or the profile.



Ohne Öffnung: bilden eine ästhetische und dichtere Beendigung des Profils. Empfohlen dort, wo das Aussehen besonders wichtig ist oder von der gegenüberliegenden Seite zur Kabeldurchführung.

Without a hole: they are an aesthetic and a tighter ending of the profile. Recommended in cases where the appearance is particularly significant, or from the opposite side to the cable outlet.



Für viele Profile bieten wir Endkappen mit Punkten für das Bohren einer Öffnung an. Mit dieser Lösung kann man aus einem Set von Endkappen jeweils eine Endkappe mit und ohne Öffnung haben.

For many products, we offer endings with points to bore a hole. Thanks to this, from one set of endings, it is possible to obtain one ending of each type: with a hole and without one.

Bezeichnung / Oznaczenia

die Bezeichnung der Abdeckungen, die mit den Befestigungssockel in dem Profil passen
marking of covers fitting the sockets in the profile

A B C C1 C2 C3 D E E7 F G H I J K





die Bezeichnung der Halter, die zu dem Profil passen
marking of holders fitting the profile

S T U U4 U5 U6 U7 W X Y Z

Profile mit der Slick Funktion
profile with Slick socket



Typen der LED Profile
LED profile categories

-  Aufbauprofile
surface
-  Einbauprofile
recessed
-  Eckprofile
corner
-  spezielle Profile
special application
-  Glaskantenprofile
glass application

sonstige
others

-  maximale Breite des LED Streifens
maximum LED strip width
-  Achtung
note
-  Montageklebstoff
assembly adhesive
-  auf Lager verfügbar
available in stock
-  Hergestellt in Polen
made in Poland
-  EU Industriedesign
EU-registered industrial design

LED Zubehör / LED accessories

Für die LED Profile kann man unterschiedliche LED Lichtquellen und elektronische Komponenten anwenden. Sehr wichtig ist die richtige Reihenfolge der Verbindung der einzelnen Elemente.

Different LED sources and electronic components can be used for aluminium LED profiles. The correct sequence of connecting individual elements is very important.

Lichtquelle / Source



Im Angebot haben wir LED Streifen mit einer unterschiedlichen Leistung, Breite und einem unterschiedlichen Lichtstrom. Zugänglich sind auch LED Streifen mit unterschiedlicher Lichtfarbe - ein Paar unterschiedliche Farbtemperaturen von weiß und Grundfarben, sowie RGB und warm- und kaltweiß LED Streifen mit der Möglichkeit die Farbtemperatur einzustellen. Am häufigsten sind die Lichtquellen für die Spannung von 12 V verwendet, aber zugänglich sind auch die Lichtquellen für 24V. Außer den auf dem Markt zugänglichen und populärsten LED Streifen, gibt es auch LED Module auf einer steifen Platte. In der Regel zeichnen sie sich durch deutlich bessere Parametern und Lichtqualität aus. Einen besonderen Teil des Angebotes bilden Lichtquellen und wasserdichte Elemente.

LED Kabel • Verbinder • Konnektoren LED cable • connectors • distribution box



Das weitere Zubehör soll man an die LED Lichtquelle anpassen: Kabel, Verbinder, Schalter, Steuerungen und Netzteile. Einige LED Lichtquellen, die auf dem Markt zugänglich sind können die Wärmeabfuhrmöglichkeiten des gewählten Profils überschreiten. Damit das LED Profil richtig funktioniert, soll man eine LED Lichtquelle mit entsprechenden Lichtparametern wählen.

Falls ein Paar Lichtquellen an einen Netzteil angeschlossen werden, kann man einen 6-fach Verteiler für Ministecker oder LED Verteiler verwenden. Unser Angebot umfasst auch Kabel mit unterschiedlicher Länge, für einfarbige LED Streifen, und für spezielle RGB Streifen.

Schalter • Kontroller / Switch • controller



Netzteil 12 V oder 24 V 12 V or 24 V power supply

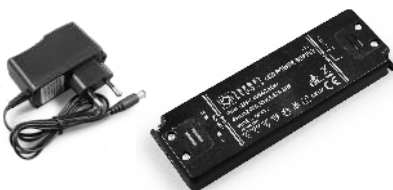

12 V

oder / or

24 V

Ein Beleuchtungsset kann man um unterschiedliche, bequeme Lösungen für das Einschalten, Dimmen und die Farbsteuerung erweitern. Zugänglich sind mechanische Schalter, die mit dem Kabel integriert sind oder Schalter zum Anschließen direkt an die Lichtquelle unter der Abdeckung und in dem Profil. Das Einschalten gelingt sowohl durch Tasten, als auch durch Funkwellen mit Hilfe von einer Fernbedienung und durch Kontroller. Gesteuert kann sowohl die Lichtfarbe (bei der Wahl einer entsprechenden Lichtquelle) als auch die Lichtstärke sein.

Kabel 220-240 V / 220-240 V cable



220
-240V

Die Wahl eines Netzteils verlangt der Umrechnung der Leistung, mit welcher die Lichtquelle, gemäß den Anweisungen des Herstellers, arbeiten wird. Der primäre Strom hat eine Spannung von 220-240 V, der sekundäre Strom, an den LEDs angeschlossen werden, hat eine Spannung von 12 V oder 24 V.

In unserem Angebot gibt es auch Netzkabel mit 220-240 V, die ermöglichen das ganze Set an Netz anzuschließen. Ein standardmäßiges Kabel ist 4 m lang, ein Kabel mit Fußschalter ist 3,5 m lang.

Mehr Details gibt es in dem LED Zubehör Katalog (Seite 9.01-9.17).

We have LED strips with different power, luminous flux and width to choose from. We also have strips available with different light colour temperatures - a few different temperatures of white, as well as RGB and warm-cold (with adjustable light colour temperature). TOPMET offer includes LED strips and modules adapted to 12 V or 24 V voltage. Waterproof sources and components are a special part of the offer.

Depending on the LED selection, you need to match the remaining accessories: cables, connectors, switches, controllers and power supplies. Some LED sources available on the market may exceed radiation capabilities of a given aluminium profile. In order to ensure correct operation, a LED source with appropriate parameters needs to be matched to an aluminium profile.

In the case of connecting a few sources to one power supply, you can use a connector for mini-connector with 6 sockets or a LED divider. Our offer also includes cables of different lengths for one colour of LED strips, as well as special ones for RGB strips.

A lighting fixture set can be enriched with different types of convenient solutions regarding switching, dimming and change of colour. Mechanical switches are available - integrated with the cable or for connecting directly to the LED source, under the cover inside the profile. Turning on is possible both by touch, as well as radio waves - with a remote control via a controller. You can control the colour (with an appropriate light source selected) as well as illuminance.

The selection of the power supply requires calculation of the power to be consumed by the source, according to the indications of the manufacturer. From the primary side, the current has a voltage of 220-240 V, on the secondary side, to which the LED is connected, the voltage is 12 V or 24 V.

220-240 V cables, which allow the connection of an entire set to the power supply are also in our offer. A standard cable is 4 m long and a cable with a foot switch - 3.5 m.

More details are available in the LED accessories catalogue (pages: 9.01-9.17).





2020

LED PROFILE
LED PROFILES

AUFBAUPROFILE / SURFACE



EIN KLEINES ALUMINIUMPROFIL FÜR AUFBAU

SMALL, ALUMINIUM, SURFACE PROFILE

- universelle Anwendung
 - Sockel mit Slick Funktion
 - zwei Rillen - zwei Niveaus der Befestigung des Halters (mit einem Abstand oder ohne Abstand von der Wand)
 - lackierte Halter
 - maximale Breite des LED Streifens 8 mm
-
- universal application
 - Slick socket
 - 2 channels for mounting bracket (with or without wall distance)
 - painted holders
 - maximum LED strip width: 8 mm

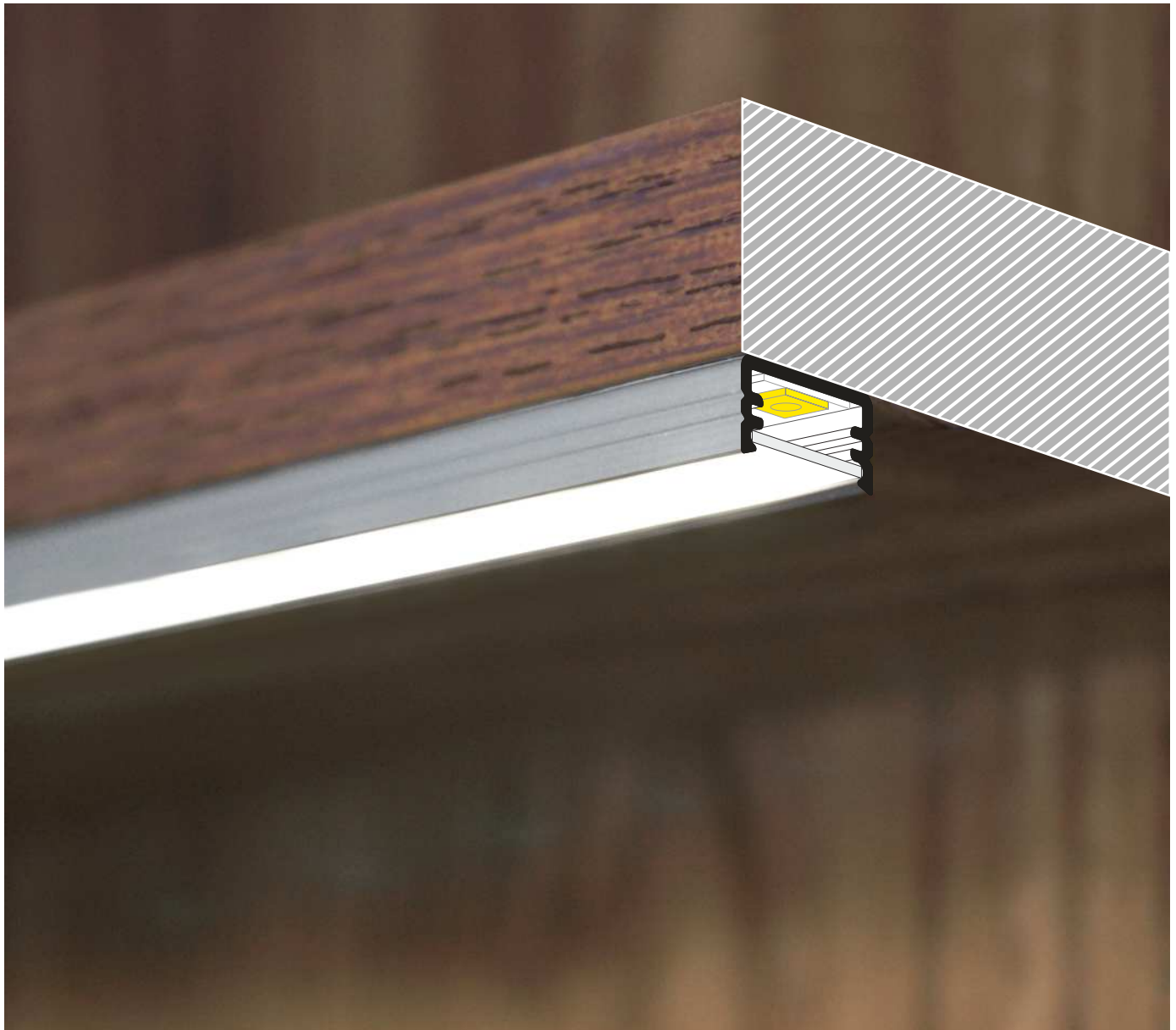

ÄHNLICHES IM ANGEBOT / SIMILAR IN THE OFFER



SMART10
AC2/Z



SURFACE10
BC/UX



BEGTON12
J/S



SURFACE14
EF/TY



A Abdeckung **A** einziehbar
A slide cover

C2 Abdeckung **C2** einclipsbar
C2 click cover

Z¹ Halter **Z** flexibel
Z flexible mounting plate

Z² Halter **Z** flexibel cone
cone Z flexible mounting plate

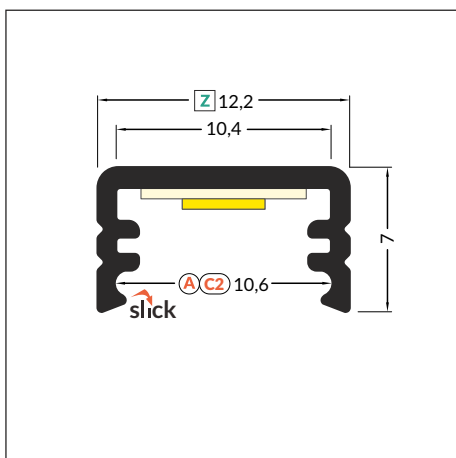
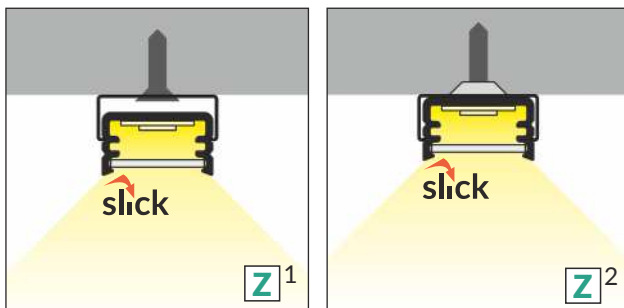
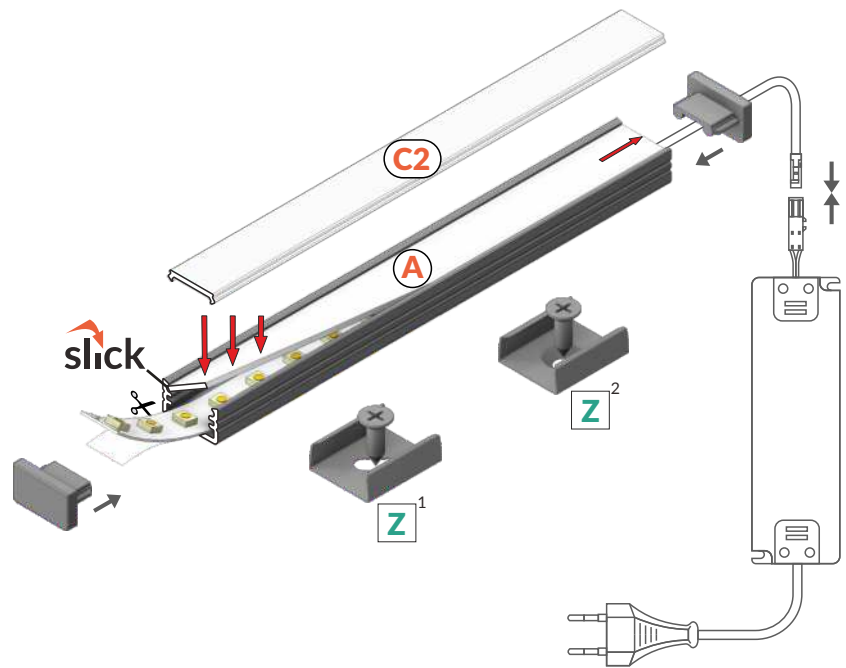

 max 8 mm

 Aufbauprofile
surface



Artikelnummer = 1 Stück, Länge 2.000 mm
Verpackung > siehe bitte Preisliste
INDEX = 1 pc, length 2000 mm
package > check the pricelist

weiß lackiert
white painted
89030001

eloxiert
anodized
89030020

schwarz eloxiert
black anodized
89030021

Rohaluminium
raw aluminium
89030000

Die zugänglichen Längen: 1000 mm, 2000 mm, 3000 mm, 4000 mm.
Die standardmäßige Toleranz der Länge von Profilen beträgt: +20 mm.
Mehr Informationen >> 1.08.

Available lengths: 1000 mm, 2000 mm, 3000 mm, 4000 mm.
The standard profile length tolerance is +20 mm.
More details >> 1.08.



ABDECKUNG / COVERS

Abdeckung A einschiebbar
Farben: transparent, satiniert, opal
Material: PC, PP, PP

A slide cover
colours: transparent, frosted, opal
material: PC, PP, PP

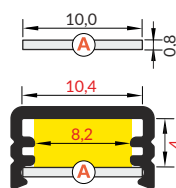

Achtung! Die Abmessungen des Platzes für die Montage von LED Lichtquelle
Note! Dimensions of the space to install LED source

Abdeckung C2 einclipsbar
Farben: transparent, opal
Material: PMMA



C2 click cover
colours: transparent, opal
material: PMMA

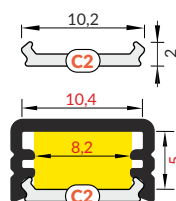

Länge 2.000 mm
Verpackung > siehe bitte Preisliste
length 2000 mm
package > check the pricelist

A transparent
Artikelnummer = 10 Stück
index = 10 pcs
89070016

A satiniert / A frosted
Artikelnummer = 10 Stück
index = 10 pcs
89070039

A opal
Artikelnummer = 10 Stück
index = 10 pcs
89070038

C2 transparent
Artikelnummer = 1 Stück
index = 1 pc
89000216

C2 opal
Artikelnummer = 1 Stück
index = 1 pc
89000238

Die Toleranz der Länge von Abdeckungen beträgt: +20 mm.
Mehr Informationen >> 1.08.

The standard cover length tolerance is +20 mm.
More details >> 1.08.

ENDKAPPEN / ENDINGS

Endkappe SLIM8
Farben: weiß, silbern, schwarz, grau
Material: ABS

SLIM8 ending
colours: white, silver, black, grey
material: ABS

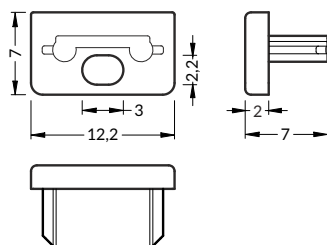

Endkappe SLIM8 mit Öffnung
Farben: weiß, silbern, schwarz, grau
Material: ABS

SLIM8 ending with hole
colours: white, silver, black, grey
material: ABS



Artikelnummer = 10 Sets = 20 Stück
Verpackung > siehe bitte Preisliste
INDEX = 10 sets = 20 pcs
package > check the pricelist

weiß / white
89080001
silbern / silver
89080040
schwarz / black
89080002
grau / grey
89080022

weiß / white
89140001
silbern / silver
89140040
schwarz / black
89140002
grau / grey
89140022

HALTER / MOUNTINGS

Halter Z flexibel
Farben: weiß, inox, schwarz
Material: rostfreier Stahl

Z flexible mounting plate
colours: white, inox, black
material: stainless steel

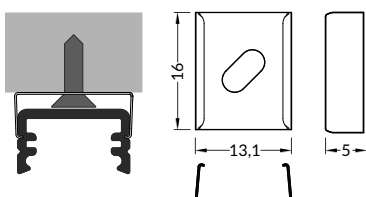

Artikelnummer = 10 Sets = 20 Stück
Verpackung > siehe bitte Preisliste
INDEX = 10 sets = 20 pcs
package > check the pricelist

weiß / white
89270001

inox
89270019

schwarz / black
89270002



HALTER / MOUNTINGS

Halter Z flexibel cone
Farben: weiß, inox, schwarz
Material: rostfreier Stahl

cone Z flexible mounting plate
colours: white, inox, black
material: stainless steel

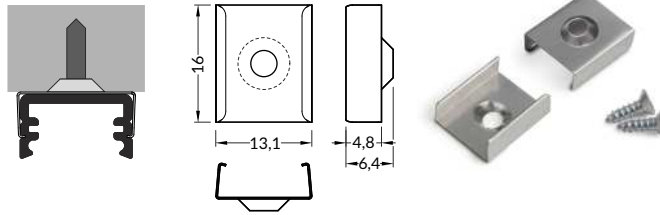

Artikelnummer = 10 Sets = 20 Stück
Verpackung > siehe bitte Preisliste
INDEX = 10 sets = 20 pcs
package > check the pricelist

weiß / white
89980001

inox
89980019

schwarz / black
89980002

Halter SLIM8 einfach
Material: verzinkter Stahl

SLIM8 simple holder
material: zinc coated steel

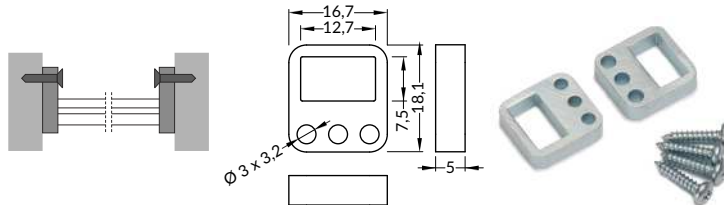

Artikelnummer = 1 Set = 2 Stück
Verpackung > siehe bitte Preisliste
INDEX = 1 set = 2 pcs
package > check the pricelist

verzinkt
zinc coated
89110030

VERBINDUNGSTÜCKE / CONNECTORS

Verbinder 90 Grad für SLIM8
Farben: weiß, eloxiert, schwarz
Material: Aluminium

SLIM8 connector 90 deg
colours: white, anodized, black
material: aluminium

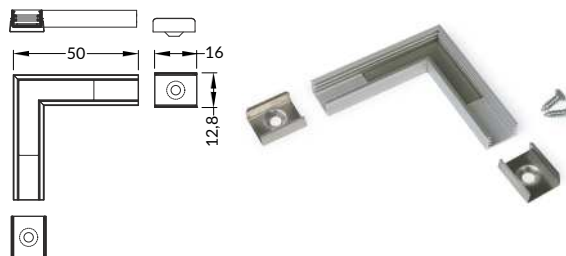

Artikelnummer = 1 Set
Verpackung > siehe bitte Preisliste
INDEX = 1 set
package > check the pricelist

weiß lackiert
white painted
89150001

eloxiert
anodized
89150020

schwarz eloxiert
black anodized
89150021

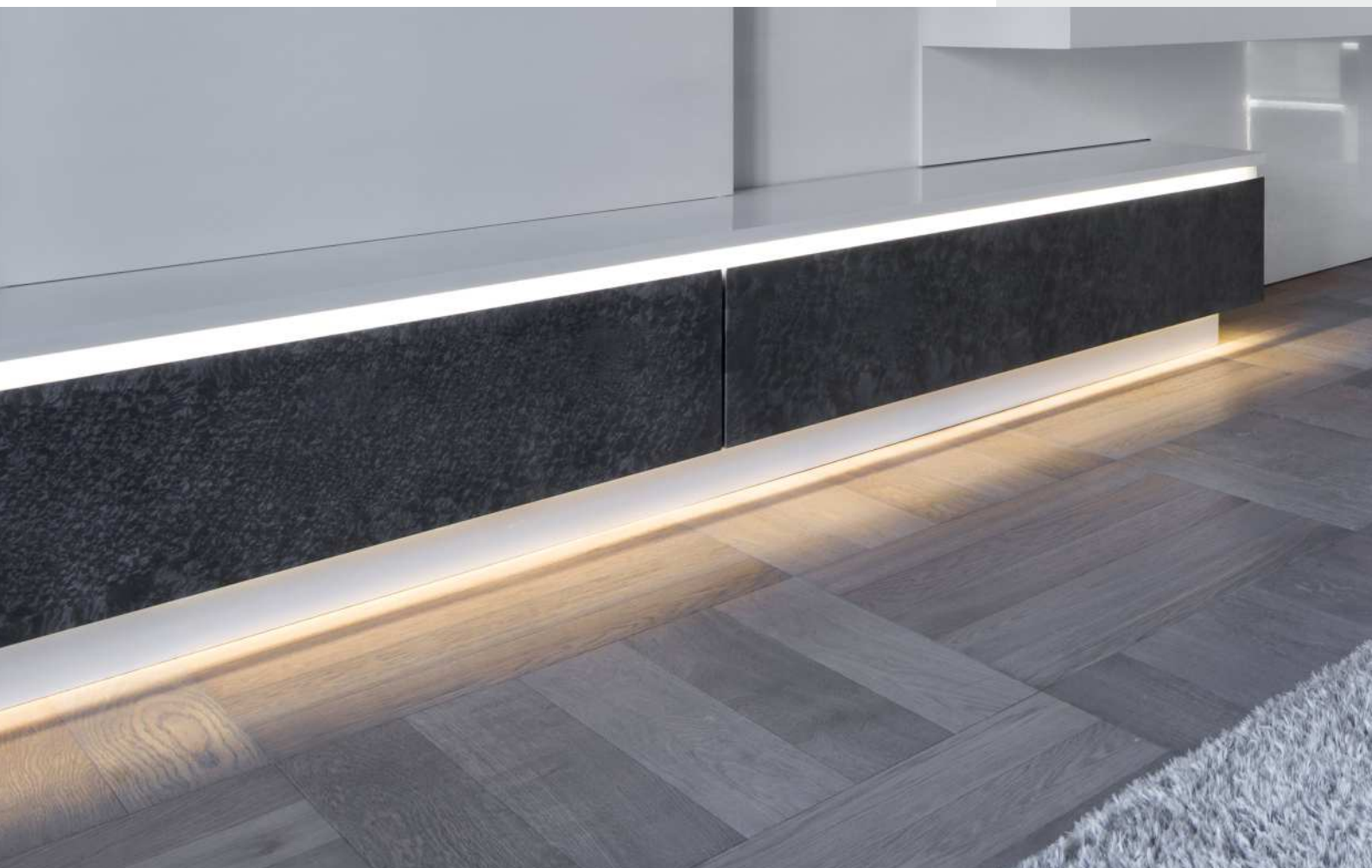

EINE HOMOGENE LICHTLINIE IN EINER KLEINEN GRÖßE

CONTINUOUS LINE OF LIGHT IN A SMALL OVERALL DIMENSIONS

- eine homogene Lichtlinie (bei LED Streifen mit 120 leds/m und einer opalen Abdeckung)
- Sockel mit Slick Funktion
- kleine Maße
- universelle Anwendung
- die Möglichkeit der Anwendung von wasserdichten LED Streifen
- maximale Breite des LED Streifens 10 mm

- continuous line of light (when using LED strip 120 P/m and opal cover)
- SLICK socket
- miniature dimensions
- universal application
- the possibility of using waterproof LED strips
- maximum width of LED strip: 10 mm

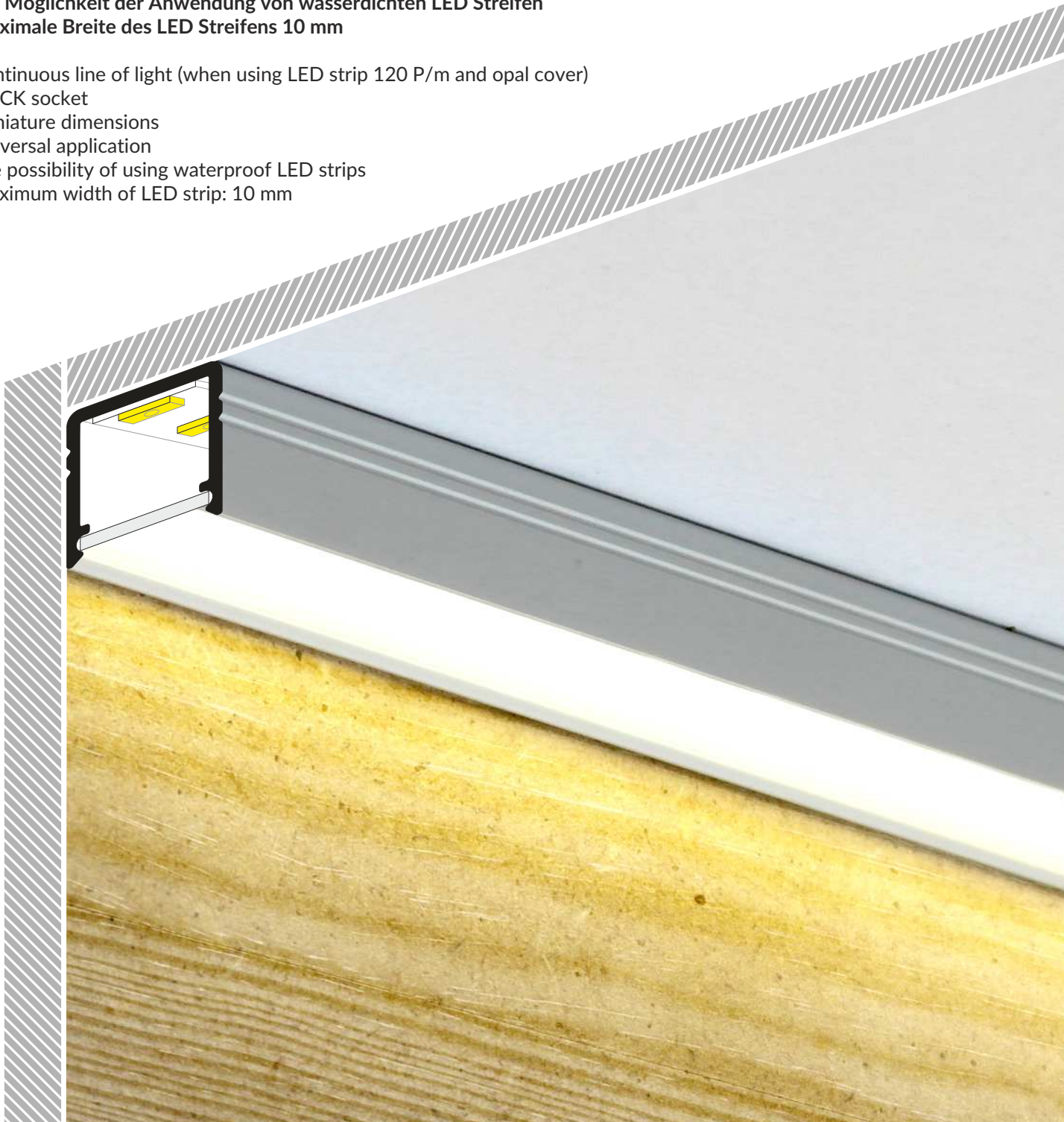

ÄHNLICHES IM ANGEBOT / SIMILAR IN THE OFFER





A Abdeckung **A** einschiebbar
A slide cover

C2 Abdeckung **C2** einclipsbar
C2 click cover

Z¹ Halter **Z** flexibel
Z flexible mounting plate

Z² Halter **Z** flexibel cone
cone Z flexible mounting plate

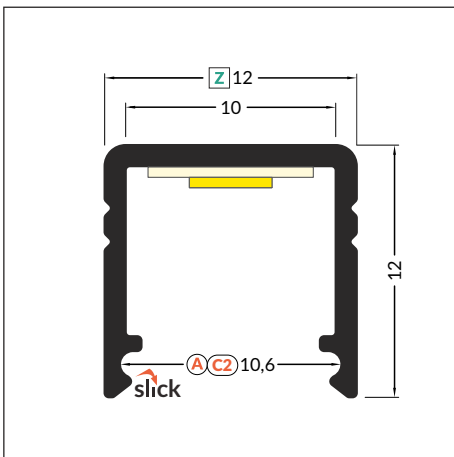
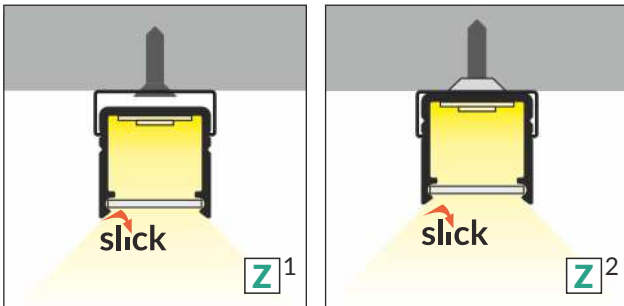
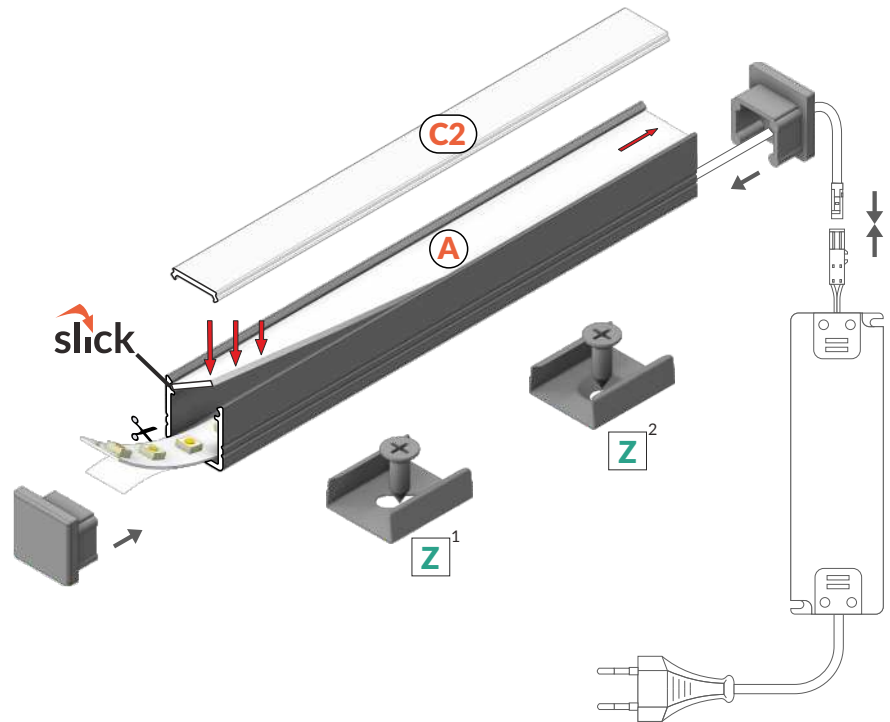

 max 10 mm

 Aufbauprofile
surface



Artikelnummer = 1 Stück, Länge 2.000 mm
Verpackung > siehe bitte Preisliste
INDEX = 1 pc, length 2000 mm
package > check the pricelist

weiß lackiert
white painted
C2020001



eloxiert
anodized
C2020020



schwarz eloxiert
black anodized
C2020021



Rohaluminium
raw aluminium
C2020000

Die zugänglichen Längen: 1000 mm, 2000 mm, 3000 mm, 4000 mm.
Die standardmäßige Toleranz der Länge von Profilen beträgt: +20 mm.
Mehr Informationen >> 1.08.

Available lengths: 1000 mm, 2000 mm, 3000 mm, 4000 mm.
The standard profile length tolerance is +20 mm.
More details >> 1.08.



ABDECKUNG / COVERS

Abdeckung A einziehbar
Farben: transparent, satiniert, opal
Material: PC, PP, PP

A slide cover
colours: transparent, frosted, opal
material: PC, PP, PP

Abdeckung C2 einclipsbar
Farben: transparent, opal
Material: PMMA



C2 click cover
colours: transparent, opal
material: PMMA



Achtung! Die Abmessungen des Platzes für die Montage von LED Lichtquelle
Note! Dimensions of the space to install LED source

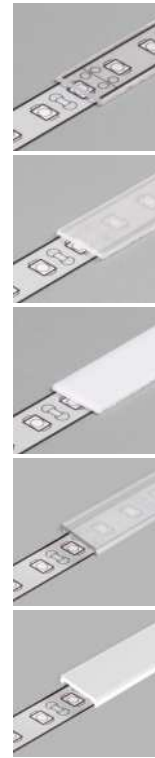
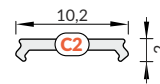
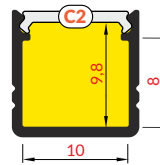
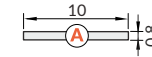
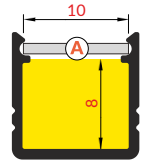

Länge 2.000 mm
Verpackung > siehe bitte Preisliste
length 2000 mm
package > check the pricelist

A transparent
Artikelnummer = 10 Stück
index = 10 pcs
89070016

A satiniert / A frosted
Artikelnummer = 10 Stück
index = 10 pcs
89070039

A opal
Artikelnummer = 10 Stück
index = 10 pcs
89070038

C2 transparent
Artikelnummer = 1 Stück
index = 1 pc
89000216

C2 opal
Artikelnummer = 1 Stück
index = 1 pc
89000238

Die Toleranz der Länge von Abdeckungen beträgt: +20 mm.
Mehr Informationen >> 1.08.
The standard cover length tolerance is +20 mm.
More details >> 1.08.

ENDKAPPEN / ENDINGS

Endkappe SMART10
Farben: weiß, silbern, schwarz, grau
Material: ABS

SMART10 ending
colours: white, silver, black, grey
material: ABS

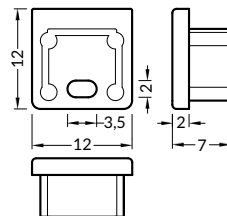

Endkappe SMART10 mit Öffnung
Farben: weiß, silbern, schwarz, grau
Material: ABS

SMART10 ending with hole
colours: white, silver, black, grey
material: ABS

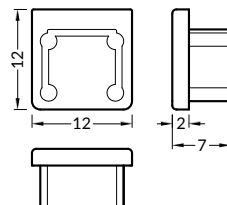

Artikelnummer = 10 Sets = 20 Stück
Verpackung > siehe bitte Preisliste
INDEX = 10 sets = 20 pcs
package > check the pricelist

weiß / white
C2940001
silbern / silver
C2940040
schwarz / black
C2940002
grau / grey
C2940022

weiß / white
C2960001
silbern / silver
C2960040
schwarz / black
C2960002
grau / grey
C2960022

HALTER / MOUNTINGS

Halter Z flexibel
Farben: weiß, inox, schwarz
Material: rostfreier Stahl

Z flexible mounting plate
colours: white, inox, black
material: stainless steel

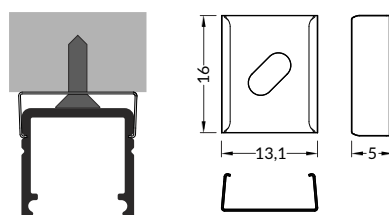

Artikelnummer = 10 Sets = 20 Stück
Verpackung > siehe bitte Preisliste
INDEX = 10 sets = 20 pcs
package > check the pricelist

weiß / white
89270001
inox
89270019
schwarz / black
89270002



HALTER / MOUNTINGS

Halter **Z** flexibel cone
Farben: weiß, inox, schwarz
Material: rostfreier Stahl

cone **Z** flexible mounting plate
colours: white, inox, black
material: stainless steel

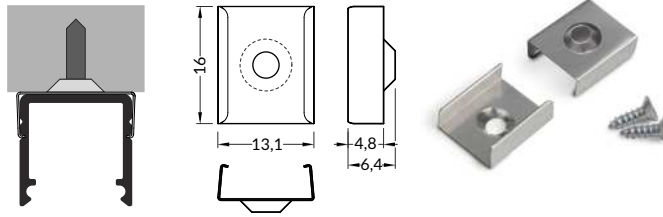

Artikelnummer = 10 Sets = 20 Stück
Verpackung > siehe bitte Preisliste
INDEX = 10 sets = 20 pcs
package > check the pricelist

weiß / white
89980001
inox
89980019
schwarz / black
89980002

VERBINDUNGSTÜCKE / CONNECTORS

Verbinder 90 Grad für SMART10
Farben: weiß, eloxiert, schwarz
Material: Aluminium

SMART10 connector 90 deg
colours: white, anodized, black
material: aluminium

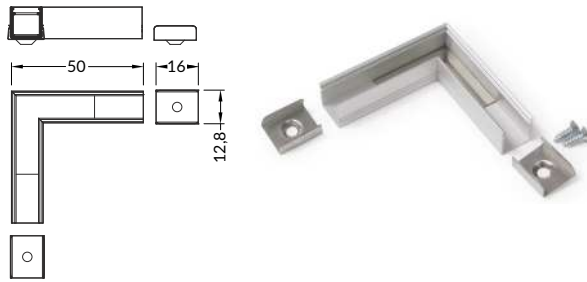

Artikelnummer = 1 Set
Verpackung > siehe bitte Preisliste
INDEX = 1 set
package > check the pricelist

weiß lackiert
white painted
C2910001

eloxiert
anodized
C2910020

schwarz eloxiert
black anodized
C2910021



SURFACE10 BC/UX

EIN ALUMINIUMPROFIL FÜR AUFBAU

ALUMINIUM SURFACE PROFILE

- eine versteckte Befestigung
- eine breite Zubehörwahl, 6 Arten der Abdeckungen
- maximale Breite des LED Streifens 10 mm

- hidden mounting
- wide range of accessories, 6 types of covers
- maximum LED strip width: 10 mm

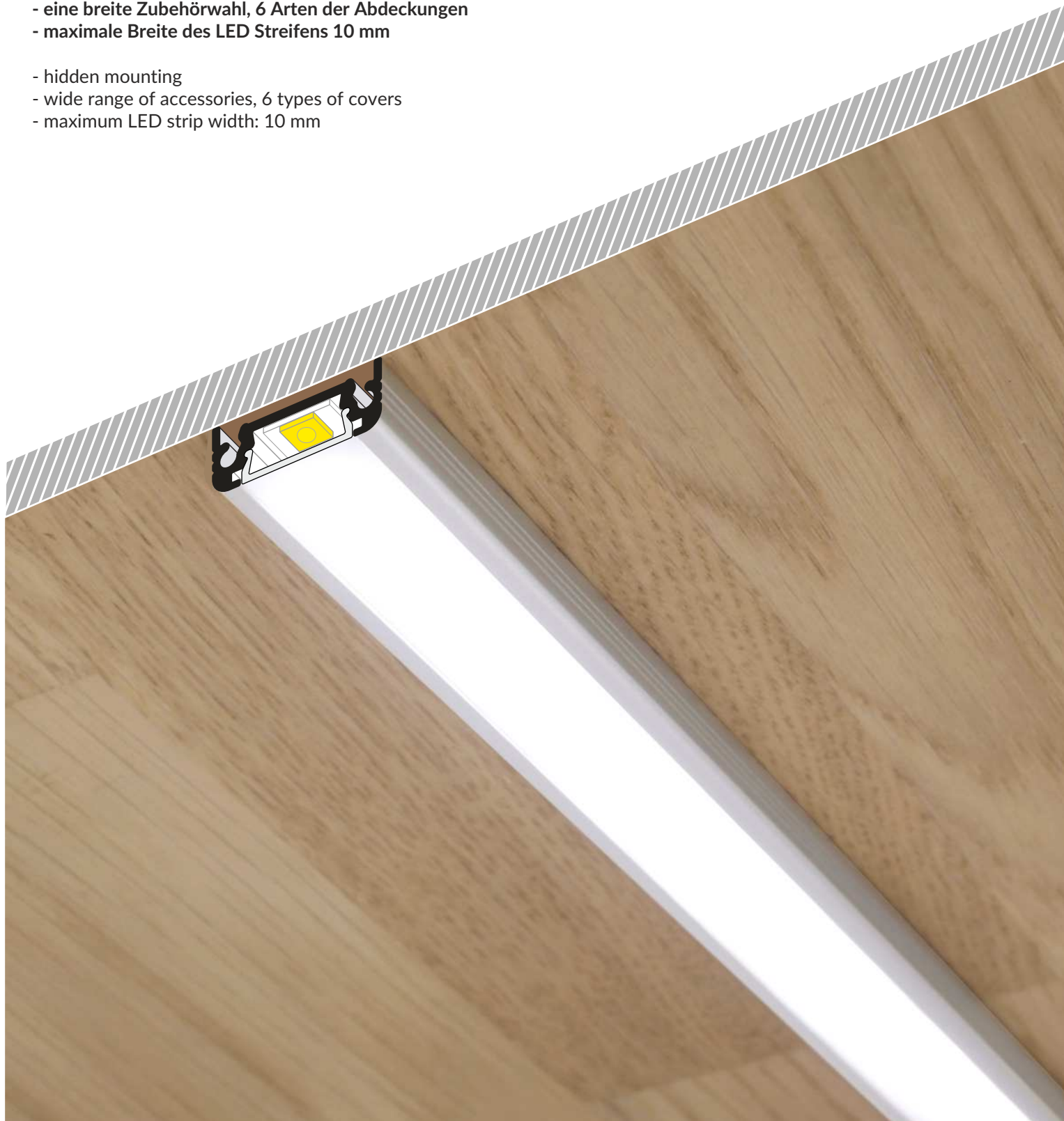

ÄHNLICHES IM ANGEBOT / SIMILAR IN THE OFFER



SLIM8
AC2/Z



SMART10
AC2/Z



BEGTON12
J/S



SURFACE14
EF/TY



LINEA20
EF/TY



WIDE24
G/W



- B** Abdeckung **B** einschiebbar
B slide cover
- C** Abdeckung **C** einclipsbar
C click cover
- C** Abdeckung **C** einclipsbar Linse
C lens cover
- U**¹ Halter **U** flexibel
U flexible mounting plate
- U**² Halter **U** flexibel cone
cone **U** flexible mounting plate
- X**¹ Halter **X**
X mounting plate

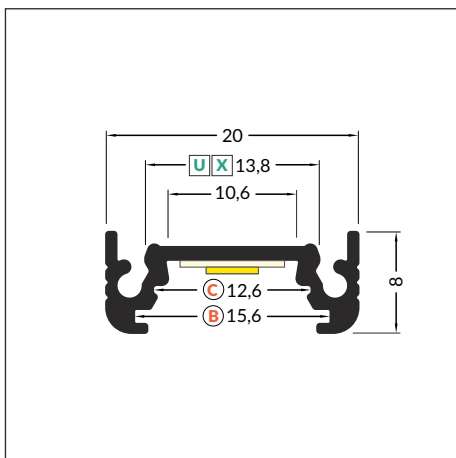
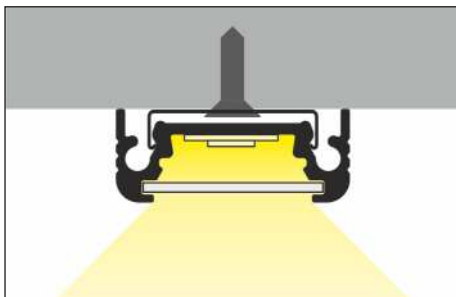
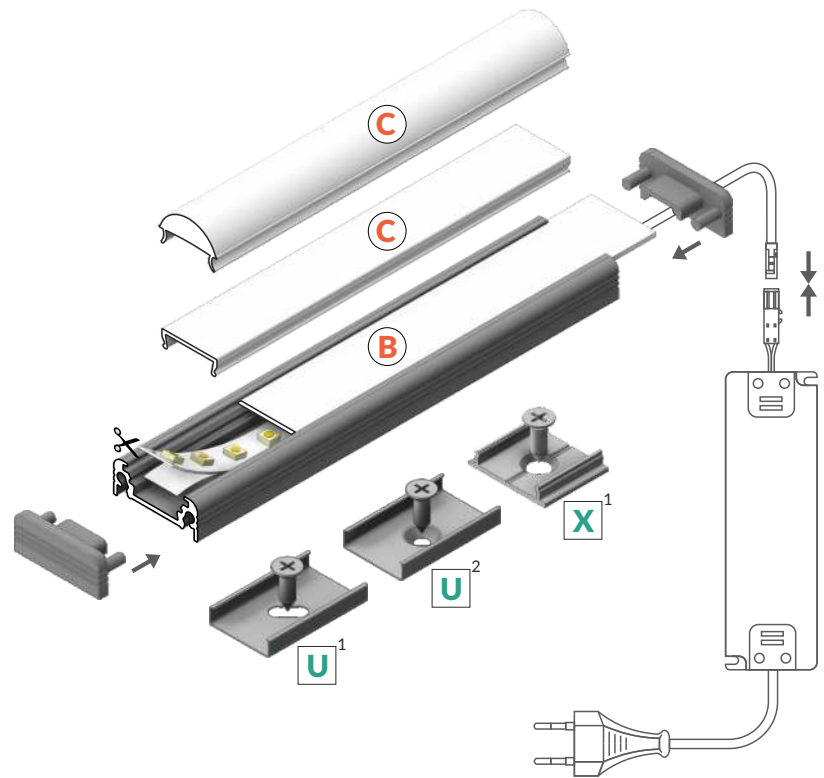

max 10 mm



Aufbauprofile
surface



Artikelnummer = 1 Stück, Länge 2.000 mm
Verpackung > siehe bitte Preisliste
INDEX = 1 pc, length 2000 mm
package > check the pricelist

weiß lackiert
white painted
77270001



eloxiert
anodized
77270020



schwarz eloxiert
black anodized
77270021



Rohaluminium
raw aluminium
77270000

Die zugänglichen Längen: 1000 mm, 2000 mm, 3000 mm, 4000 mm.
Die standardmäßige Toleranz der Länge von Profilen beträgt: +20 mm.
Mehr Informationen >> 1.08.

Available lengths: 1000 mm, 2000 mm, 3000 mm, 4000 mm.
The standard profile length tolerance is +20 mm.
More details >> 1.08.



ABDECKUNG / COVERS

Abdeckung B einschiebbar
Farben: transparent, satiniert, opal
Material: PC, PP, PP

B slide cover
colours: transparent, frosted, opal
material: PC, PP, PP

Abdeckung C einclipsbar
Farben: transparent, opal
Material: PMMA

C click cover
colours: transparent, opal
material: PMMA

Abdeckung C einclipsbar Linse
Farben: transparent
Material: PC

C click cover lens
colour: transparent
material: PC



Achtung! Die Abmessungen des Platzes für die Montage von LED Lichtquelle
Note! Dimensions of the space to install LED source

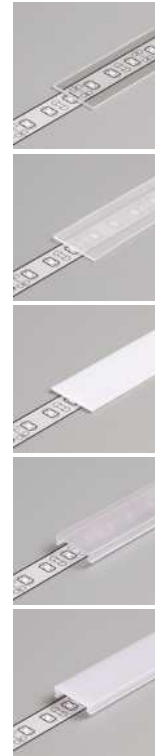
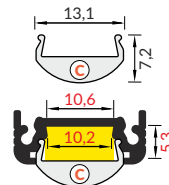
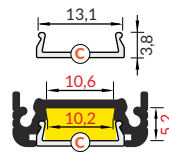
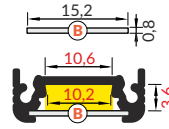

Länge 2.000 mm,
Verpackung > siehe bitte Preisliste
length 2000 mm
package > check the pricelist

B transparent
Artikelnummer = 10 Stück
index = 10 pcs
76250016

B satiniert / B frosted
Artikelnummer = 10 Stück
index = 10 pcs
76250039

B opal
Artikelnummer = 10 Stück
index = 10 pcs
76250038

C transparent
Artikelnummer = 1 Stück
index = 1 pc
76330000

C opal
Artikelnummer = 1 Stück
index = 1 pc
76330038

NEU



Rolle, Länge 20 m,
Verpackung > siehe bitte Preisliste
reel, length 20 m
package > check the pricelist

C opal
Artikelnummer = 1 Stück
index = 1 pc
76360038S



Länge 2.000 mm,
Verpackung > siehe bitte Preisliste
length 2000 mm
package > check the pricelist

C Linse / C lens
Artikelnummer = 1 Stück
index = 1 pc
76300000

Die Toleranz der Länge von Abdeckungen beträgt: +20 mm.
Mehr Informationen >> 1.08.
The standard cover length tolerance is +20 mm.
More details >> 1.08.

HALTER / MOUNTINGS

Halter U flexibel
Farben: inox
Material: rostfreier Stahl

U flexible mounting plate
colours: inox
material: stainless steel

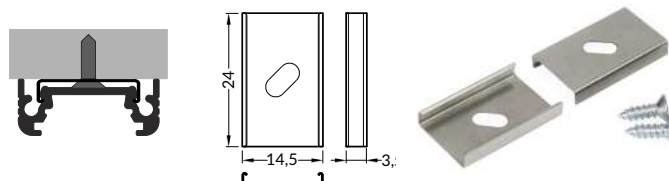

Halter U flexibel cone
Farben: inox
Material: rostfreier Stahl

cone **U** flexible mounting plate
colours: inox
material: stainless steel

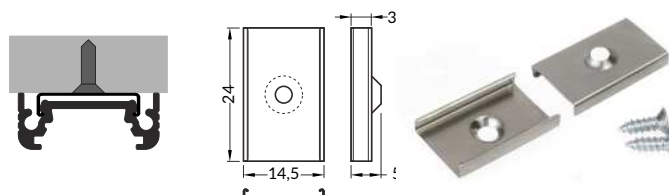

Halter X
Farben: Rohaluminium
Material: aluminium

X mounting plate
colours: raw aluminium
material: aluminium

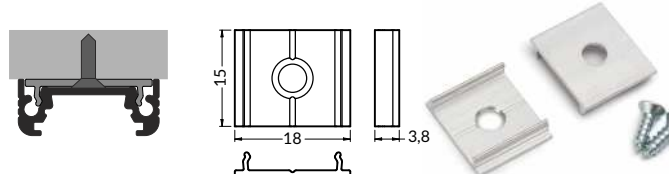

Artikelnummer = 10 Sets = 20 Stück
Verpackung > siehe bitte Preisliste
INDEX = 10 sets = 20 pcs
package > check the pricelist

inox
76380000

inox
76620000

Rohaluminium
raw aluminium
76260000



HALTER / MOUNTINGS

Halter SURFACE10 einfach
Material: verzinkter Stahl
SURFACE10 simple holder
material: zinc coated

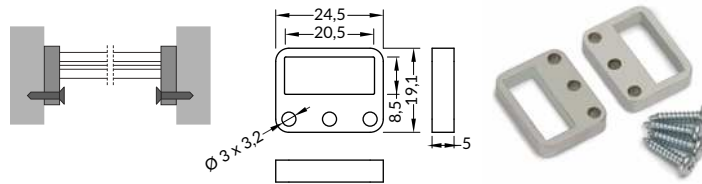

Artikelnummer = 1 Set = 2 Stück
Verpackung > siehe bitte Preisliste
INDEX = 1 set = 2 pcs
package > check the pricelist

verzinkt / zinc coated
77370030

ENDKAPPEN / ENDINGS

Endkappe SURFACE10 gen2
Farben: weiß, silbern, schwarz, grau
Material: ABS
SURFACE10 ending gen2
colours: white, silver, black, grey
material: ABS

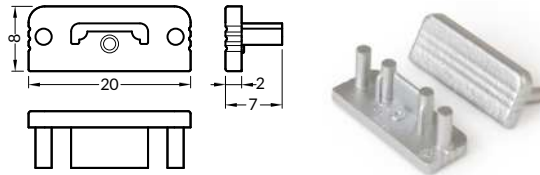

Artikelnummer = 10 Sets = 20 Stück
Verpackung > siehe bitte Preisliste
INDEX = 10 sets = 20 pcs
package > check the pricelist

weiß / white
77990001
silbern / silver
77990040
schwarz / black
77990002
grau / grey
77990022

Endkappe SURFACE10 gen2 mit Öffnung
Farben: weiß, silbern, schwarz, grau
Material: ABS
SURFACE10 ending gen2 with hole
colours: white, silver, black, grey
material: ABS

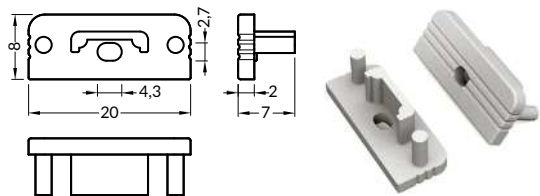

weiß / white
77980001
silbern / silver
77980040
schwarz / black
77980002
grau / grey
77980022

VERBINDUNGSSTÜCKE / CONNECTORS

Verbindungsstück X 180 Grad
Farben: inox
Material: Aluminium
X connector 180 deg
colour: inox
material: aluminium

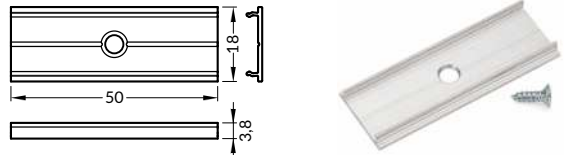

Artikelnummer = 1 Set
Verpackung > siehe bitte Preisliste
INDEX = 1 set
package > check the pricelist

Rohaluminium
raw aluminium
76350000

Verbinder 90 Grad für SURFACE10
Farben: weiß, eloxiert, schwarz
Material: Aluminium
SURFACE10 connector 90 deg
colours: white, anodized, black
material: aluminium

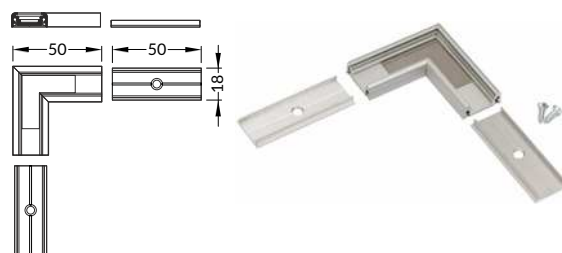

weiß lackiert
white painted
77410001

eloxiert
anodized
77410020

schwarz eloxiert
black anodized
77410021



EIN KLEINES ALUMINIUMPROFIL FÜR AUFBAU

SMALL SURFACE ALUMINIUM PROFILE

- ein leichtes Budget-Profil
- Sockel mit Slick Funktion
- maximale Breite des LED Streifens 12 mm

- light weight, budget profile
- Slick socket
- maximum LED strip width: 12 mm



ÄHNLICHES IM ANGEBOT / SIMILAR IN THE OFFER



SLIM8
AC2/Z



SMART10
AC2/Z



SURFACE10
BC/UX



BEGTON12
J/S



SURFACE14
EF/TY



J Abdeckung **J** einschiebbar
J slide cover

C Abdeckung **C** einclipbar
C click cover

C* die Endkappe Begton12 **C** für die Abdeckung **C** einclipbar
BEGTON12 C ending for **C** click cover

S¹ Halter **S** flexibel
S flexible mounting plate

S² Halter **S** flexibel cone
S cone flexible mounting plate

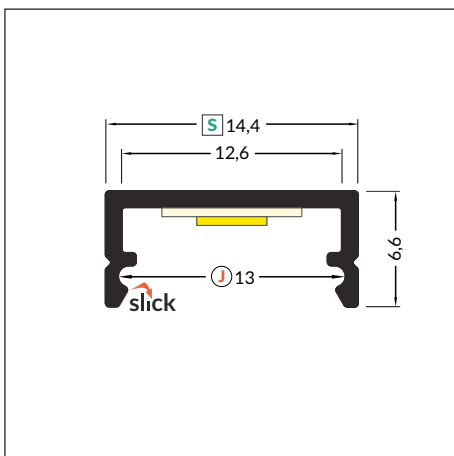
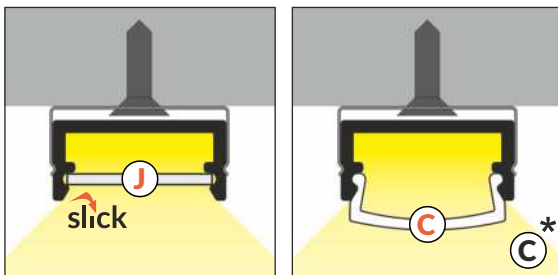
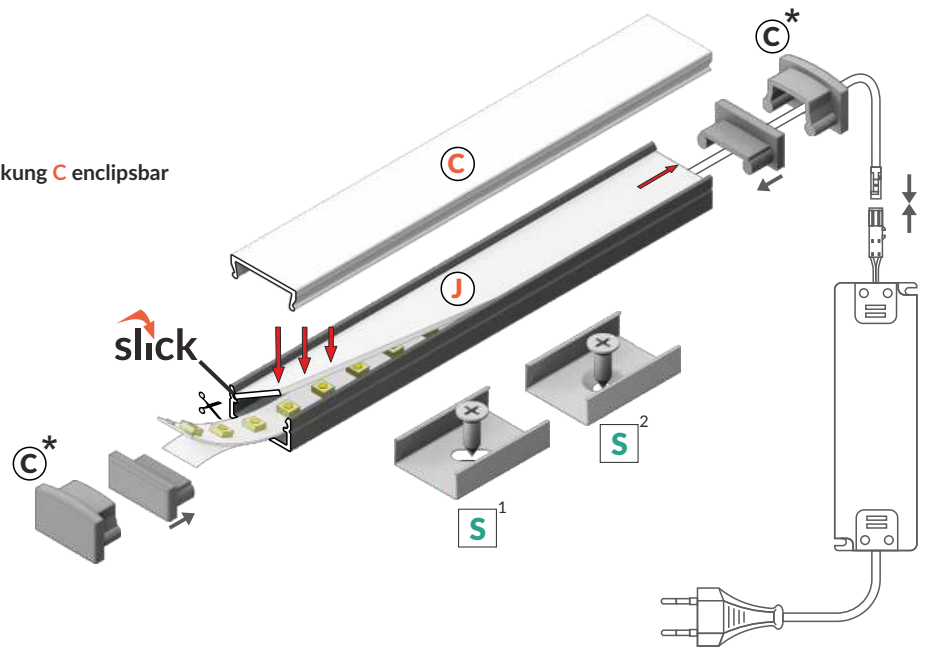

max 12 mm

Aufbauprofile
surface



Artikelnummer = 1 Stück, Länge 2.000 mm
 Verpackung > siehe bitte Preisliste
 INDEX = 1 pc, length 2000 mm
 package > check the pricelist

weiß lackiert
 white painted
C7020001

eloxiert
 anodized
C7020020

schwarz eloxiert
 black anodized
C7020021

Rohaluminium
 raw aluminium
C7020000

Die zugänglichen Längen: 1000 mm, 2000 mm, 3000 mm, 4000 mm.
 Die standardmäßige Toleranz der Länge von Profilen beträgt: +20 mm.
 Mehr Informationen >> 1.08.

Available lengths: 1000 mm, 2000 mm, 3000 mm, 4000 mm.
 The standard profile length tolerance is +20 mm.
 More details >> 1.08.



ABDECKUNG / COVERS

Abdeckung **J** einschiebbar
Farben: transparent, satiniert, opal
Material: PC, PP, PP

J slide cover
colours: transparent, frosted, opal
material: PC, PP, PP



Achtung! Die Abmessungen des Platzes für die Montage von LED Lichtquelle
Note! Dimensions of the space to install LED source

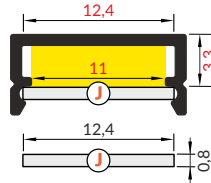

Länge 2.000 mm,
Verpackung > siehe bitte Preisliste
length 2000 mm
package > check the pricelist

J transparent
Artikelnummer = 10 Stück
index = 10 pcs
70330016

J satiniert / J frosted
Artikelnummer = 10 Stück
index = 10 pcs
70330039

J opal
Artikelnummer = 10 Stück
index = 10 pcs
70330038

Die Toleranz der Länge von Abdeckungen beträgt: +20 mm.
Mehr Informationen >> 1.08.
The standard cover length tolerance is +20 mm.
More details >> 1.08.

ENDKAPPEN / ENDINGS

Endkappe **BEGTON12**
Farben: weiß, silbern, schwarz, grau
Material: ABS
BEGTON12 ending
colours: white, silver, black, grey
material: ABS

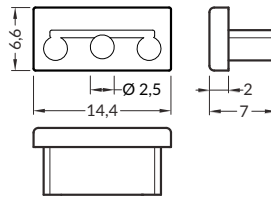

Die Endkappe mit Punkten für das Bohren von Öffnungen.
Ending with marked space to bore the holes.

Endkappe **BEGTON12 C**
Farben: weiß, silbern, schwarz, grau
Material: ABS
BEGTON12 C ending
colours: white, silver, black, grey
material: ABS

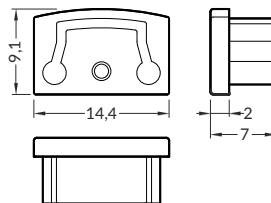

Artikelnummer = 10 Sets = 20 Stück
Verpackung > siehe bitte Preisliste
INDEX = 10 sets = 20 pcs
package > check the pricelist

weiß / white
C7960001
silbern / silver
C7960040
schwarz / black
C7960002
grau / grey
C7960022

weiß / white
C7940001
silbern / silver
C7940040
schwarz / black
C7940002
grau / grey
C7940022

HALTER / MOUNTINGS

Halter **S flexibel**
Farben: weiß, inox, schwarz
Material: rostfreier Stahl
S flexible mounting plate
colours: white, inox, black
material: stainless steel

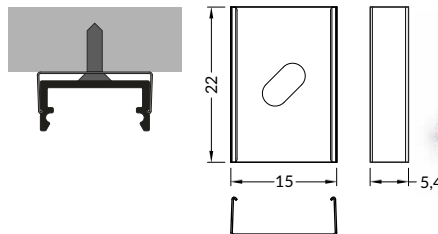

Halter **S flexibel cone**
Farben: weiß, inox, schwarz
Material: rostfreier Stahl
cone **S** flexible mounting plate
colours: white, inox, black
material: stainless steel

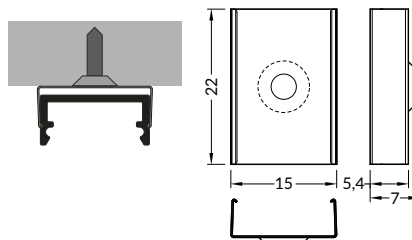

Artikelnummer = 10 Sets = 20 Stück
Verpackung > siehe bitte Preisliste
INDEX = 10 sets = 20 pcs
package > check the pricelist

weiß / white
C7980001
inox
C7980019
schwarz / black
C7980002

weiß / white
C7950001
inox
C7950019
schwarz / black
C7950002



UNI12 BCD/U

EIN EINBAU-AUFBAUPROFIL

SURFACE AND RECESSED PROFILE

- 7 Abdeckungen zur Wahl
- erhöhte Radiation – die Möglichkeit der Anwendung eines stärkeren LED Streifens
- maximale Breite des LED Streifens 12 mm

- 7 diffusers to choose from
- increased radiation – it is possible to use a stronger LED strip
- maximum LED strip width: 12 mm



ÄHNLICHES IM ANGEBOT / SIMILAR IN THE OFFER



DEEP10
BC/UX



GROOVE10
BC/UX



SURFACE10
BC/UX



FLOOR12
K/U



UNI-TILE12
90 deg C



UNI-TILE12
180 deg C



UNI-TILE12
270 deg C



- B** Abdeckung **B** einschiebbar
B slide cover
- C** Abdeckung **C** einclipsbar
C click cover
- C** Abdeckung **C** einclipsbar Linse
C lens cover
- D** Abdeckung **D** einclipsbar
D click cover
- U**¹ Halter **U** flexibel
U flexible mounting plate
- U**² Halter **U** flexibel cone
cone U flexible mounting plate

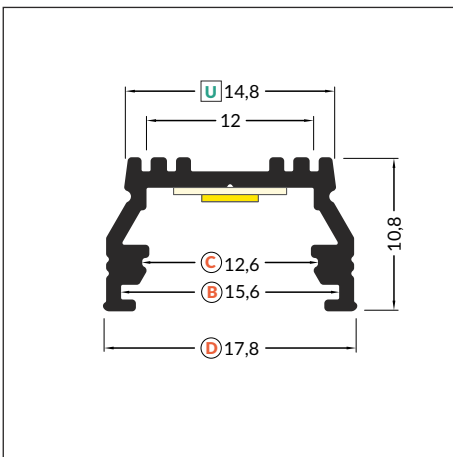
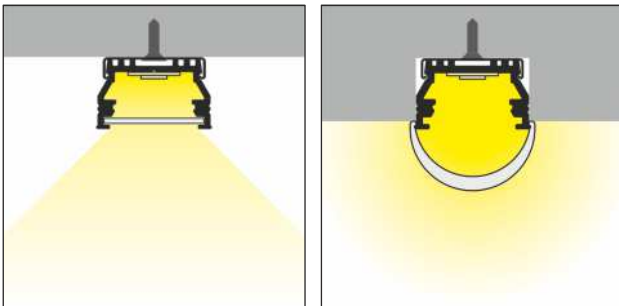
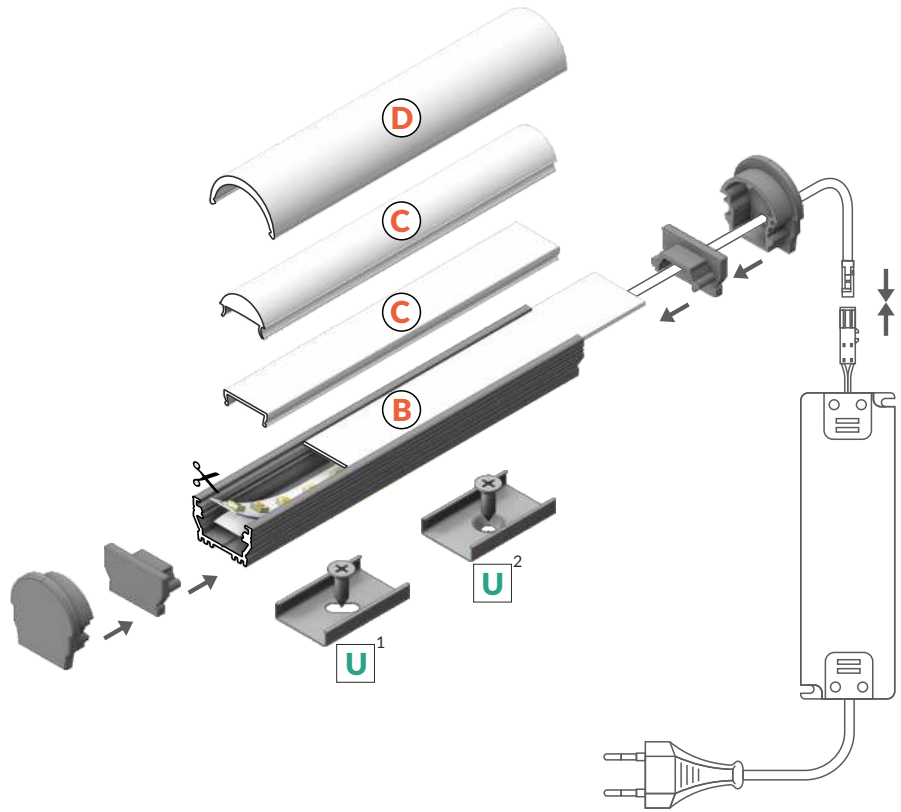

 max 12 mm

 Aufbauprofile
surface

 Einbauprofile
recessed



Artikelnummer = 1 Stück, Länge 2.000 mm
Verpackung > siehe bitte Preisliste
INDEX = 1 pc, length 2000 mm
package > check the pricelist

weiß lackiert
white painted
A1020001

eloxiert
anodized
A1020020

schwarz eloxiert
black anodized
A1020021

Rohaluminium
raw aluminium
A1020000

Die zugänglichen Längen: 1000 mm, 2000 mm, 3000 mm, 4000 mm.
Die standardmäßige Toleranz der Länge von Profilen beträgt: +20 mm.
Mehr Informationen >> 1.08.

Available lengths: 1000 mm, 2000 mm, 3000 mm, 4000 mm.
The standard profile length tolerance is +20 mm.
More details >> 1.08.



ABDECKUNG / COVERS

Abdeckung **B** einschiebbar

Farben: transparent, satiniert, opal
Material: PC, PP, PP

B slide cover

colours: transparent, frosted, opal
material: PC, PP, PP



Achtung! Die Abmessungen des Platzes für die Montage von LED Lichtquelle
Note! Dimensions of the space to install LED source

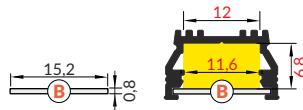

Länge 2.000 mm,
Verpackung > siehe bitte Preisliste
length 2000 mm
package > check the pricelist

B transparent

Artikelnummer = 10 Stück
index = 10 pcs

76250016



B satiniert / B frosted

Artikelnummer = 10 Stück
index = 10 pcs

76250039

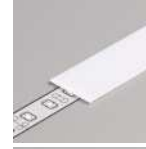

B opal

Artikelnummer = 10 Stück
index = 10 pcs

76250038



C transparent

Artikelnummer = 1 Stück
index = 1 pc

76330000



C opal

Artikelnummer = 1 Stück
index = 1 pc

76330038

Abdeckung **C** einclipsbar

Farben: transparent, opal
Material: PMMA

C click cover

colours: transparent, opal
material: PMMA

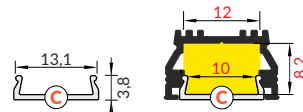

Abdeckung **C** einclipsbar Linse

Farben: transparent
Material: PC

C click cover lens

colour: transparent
material: PC

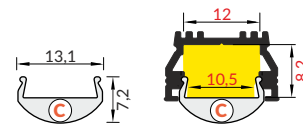

Abdeckung **D** einclipsbar

Farben: opal
Material: PMMA

D click cover

colours: opal
material: PMMA

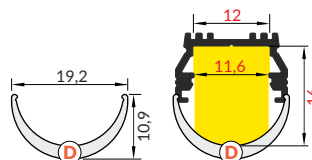

Rolle, Länge 20 m,
Verpackung > siehe bitte Preisliste
reel, length 20 m
package > check the pricelist

C opal

Artikelnummer = 1 Stück
index = 1 pc

763600385



Länge 2.000 mm,
Verpackung > siehe bitte Preisliste
length 2000 mm
package > check the pricelist

C Linse / C lens

Artikelnummer = 1 Stück
index = 1 pc

76300000



D opal

Artikelnummer = 1 Stück
index = 1 pc

A1140038

Die Toleranz der Länge von Abdeckungen beträgt: +20 mm.
Mehr Informationen >> 1.08.

The standard cover length tolerance is +20 mm.
More details >> 1.08.

HALTER / MOUNTINGS

Halter **U** flexibel

Farben: inox

Material: rostfreier Stahl

U flexible mounting plate

colour: inox

material: stainless steel

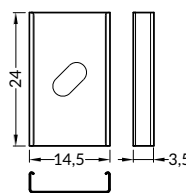
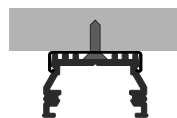

Artikelnummer = 10 Sets = 20 Stück
Verpackung > siehe bitte Preisliste
INDEX = 10 sets = 20 pcs
package > check the pricelist

inox

76380000

Halter **U** flexibel cone

Farben: inox

Material: rostfreier Stahl

cone **U** flexible mounting plate

colour: inox

material: stainless steel

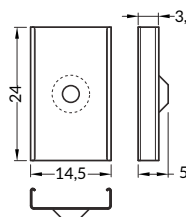
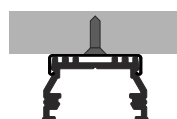

inox

76620000



VERBINDUNGSTÜCKE / CONNECTORS

Verbinder 90 Grad für UNI12
Farben: weiß, eloxiert, schwarz
Material: Aluminium

UNI12 connector 90 deg
colours: white, anodized, black
material: aluminium

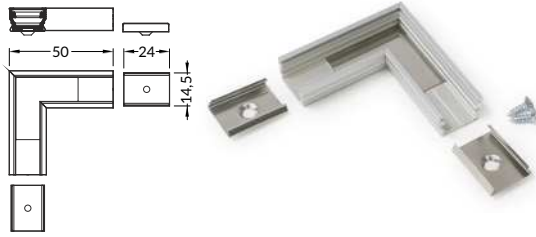

Artikelnummer = 1 Set
Verpackung > siehe bitte Preisliste
INDEX = 1 set
package > check the pricelist

weiß lackiert
white painted
A1910001

eloxiert
anodized
A1910020

schwarz eloxiert
black anodized
A1910021

ENDKAPPEN / ENDINGS

Endkappe UNI12 gen2
Farben: weiß, silbern, schwarz, grau
Material: ABS

UNI12 ending gen2
colours: white, silver, black, grey
material: ABS

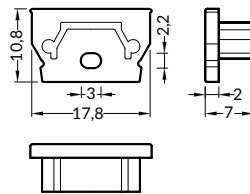

weiß / white
A1900001
silbern / silver
A1900040
schwarz / black
A1900002
grau / grey
A1900022

Endkappe UNI12 gen2 mit Öffnung
Farben: weiß, silbern, schwarz, grau
Material: ABS

UNI12 ending gen2 with hole
colours: white, silver, black, grey
material: ABS



weiß / white
A1890001
silbern / silver
A1890040
schwarz / black
A1890002
grau / grey
A1890022

Endkappe UNI12 D
Farben: weiß, silbern, schwarz, grau
Material: ABS

UNI12 D ending
colours: white, silver, black, grey
material: ABS

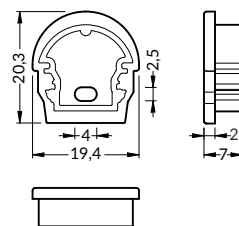

weiß / white
A1940001
silbern / silver
A1940040
schwarz / black
A1940002
grau / grey
A1940022

Endkappe UNI12 D mit Öffnung
Farben: weiß, silbern, schwarz, grau
Material: ABS

UNI12 D ending with hole
colours: white, silver, black, grey
material: ABS



weiß / white
A1960001
silbern / silver
A1960040
schwarz / black
A1960002
grau / grey
A1960022



SURFACE14 EF/TY

EIN ALUMINIUMPROFIL FÜR AUFBAU

ALUMINIUM SURFACE PROFILE

- eine versteckte Befestigung
- maximale Breite des LED Streifens 14 mm
- hidden mounting
- maximum LED strip width: 14 mm

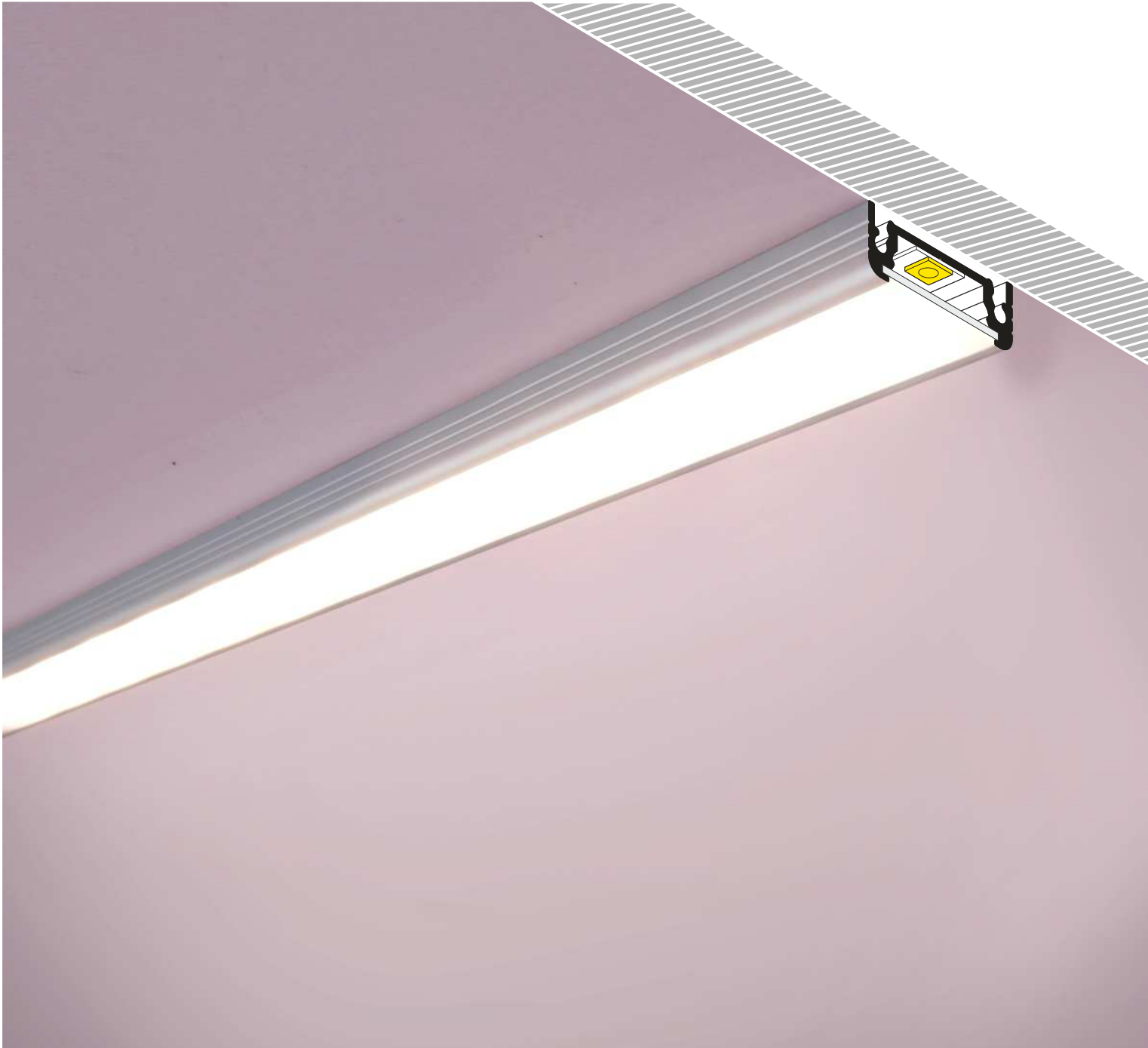

ÄHNLICHES IM ANGEBOT / SIMILAR IN THE OFFER



SLIM8
AC2/Z



SMART10
AC2/Z



SURFACE10
BC/UX



LINEA20
EF/TY



WIDE24
G/W



E Abdeckung **E** einschiebbar
E slide cover

F Abdeckung **F** einclipsbar
F click cover

E7 Abdeckung **E7** einclipsbar
E7 click cover

Y¹ Halter **Y** flexibel
Y flexible mounting plate

Y² Halter **Y** flexibel cone
cone Y flexible mounting plate

T Halter **T**
T mounting plate

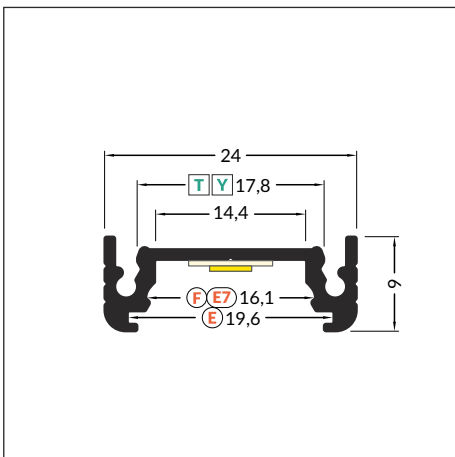
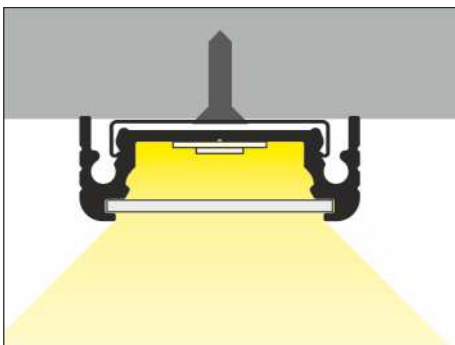
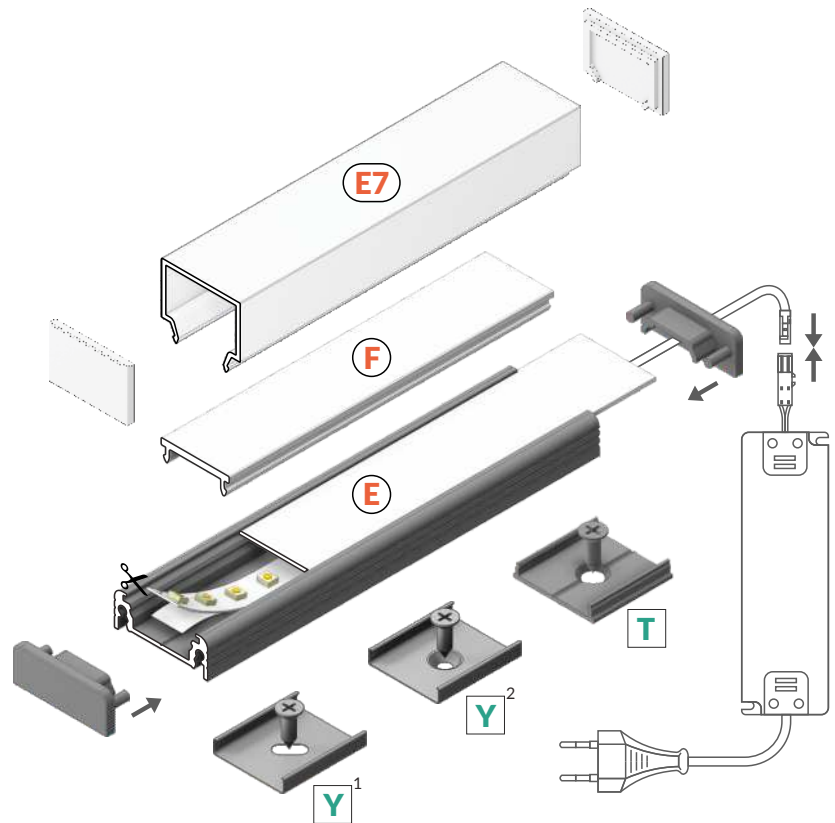

 max 14 mm

 Aufbauprofile
surface



Artikelnummer = 1 Stück, Länge 2.000 mm
Verpackung > siehe bitte Preisliste
INDEX = 1 pc, length 2000 mm
package > check the pricelist

weiß lackiert
white painted
A2020001



eloxiert
anodized
A2020020



schwarz eloxiert
black anodized
A2020021



Rohaluminium
raw aluminium
A2020000

Die zugänglichen Längen: 1000 mm, 2000 mm, 3000 mm, 4000 mm.
Die standardmäßige Toleranz der Länge von Profilen beträgt: +20 mm.
Mehr Informationen >> 1.08.

Available lengths: 1000 mm, 2000 mm, 3000 mm, 4000 mm.
The standard profile length tolerance is +20 mm.
More details >> 1.08.



ABDECKUNG / COVERS

Abdeckung E einziehbar
Farben: transparent, satiniert, opal
Material: PC, PP, PP

E slide cover
colours: transparent, frosted, opal
material: PC, PP, PP



Achtung! Die Abmessungen des Platzes für die Montage von LED Lichtquelle
Note! Dimensions of the space to install LED source

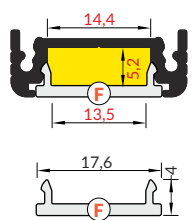
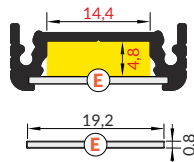

Abdeckung F einclipsbar
Farben: transparent, opal
Material: PMMA

F click cover
colours: transparent, opal
material: PMMA

Abdeckung E7 einclipsbar
Farben: opal
Material: PMMA

E7 click cover
colour: opal
material: PMMA

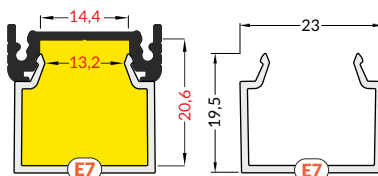

NEU

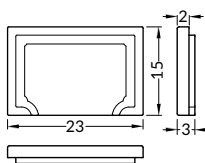

Länge 2.000 mm,
Verpackung > siehe bitte Preisliste
length 2000 mm
package > check the pricelist

E transparent
Artikelnummer = 10 Stück
index = 10 pcs
A2040016

E satiniert / E frosted
Artikelnummer = 10 Stück
index = 10 pcs
A2040039

E opal
Artikelnummer = 10 Stück
index = 10 pcs
A2040038

F transparent
Artikelnummer = 1 Stück
index = 1 pc
A2060016

F opal
Artikelnummer = 1 Stück
index = 1 pc
A2060038

Rolle, Länge 20 m,
Verpackung > siehe bitte Preisliste
reel, length 20 m
package > check the pricelist

F opal
Artikelnummer = 1 Stück
index = 1 pc
A2210038S

Länge 2.000 mm,
Verpackung > siehe bitte Preisliste
length 2000 mm
package > check the pricelist

E7 opal
Artikelnummer = 1 Stück
index = 1 pc
C1080038

Die Toleranz der Länge von Abdeckungen beträgt: +20 mm.
Mehr Informationen >> 1.08.
The standard cover length tolerance is +20 mm.
More details >> 1.08.

HALTER / MOUNTINGS

Halter Y flexibel
Farben: inox
Material: rostfreier Stahl
Y flexible mounting plate
colour: inox
material: stainless steel

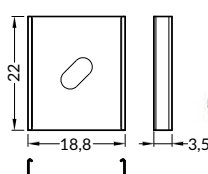
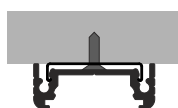

Halter Y flexibel cone
Farben: inox
Material: rostfreier Stahl
cone **Y** flexible mounting plate
colour: inox
material: stainless steel

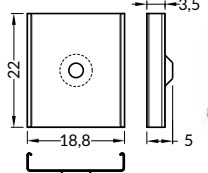
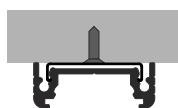

Artikelnummer = 1 Set = 2 Stück
Verpackung > siehe bitte Preisliste
INDEX = 1 set = 2 pcs
package > check the pricelist

Endkappe **E7** opal
E7 opal ending
C1840038

Artikelnummer = 10 Sets = 20 Stück
Verpackung > siehe bitte Preisliste
INDEX = 10 sets = 20 pcs
package > check the pricelist

inox
A2090019

inox
A2130019



Halter T
Farben: Rohaluminium
Material: Aluminium

T mounting plate
colour: raw aluminium
material: aluminium

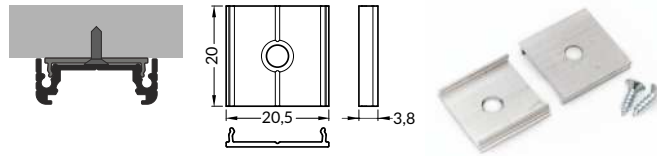

Artikelnummer = 10 Sets = 20 Stück
Verpackung > siehe bitte Preisliste
INDEX = 10 sets = 20 pcs
package > check the pricelist

Rohaluminium
raw aluminium
C6960000

ENDKAPPEN / ENDINGS

Endkappe SURFACE14 gen2
Farben: weiß, silbern, schwarz, grau
Material: ABS

SURFACE14 ending gen2
colours: white, silver, black, grey
material: ABS

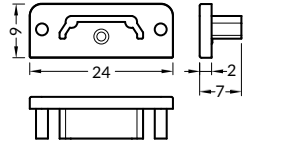

Artikelnummer = 10 Sets = 20 Stück
Verpackung > siehe bitte Preisliste
INDEX = 10 sets = 20 pcs
package > check the pricelist

weiß / white
A2980001
silbern / silver
A2980040
schwarz / black
A2980002
grau / grey
A2980022

Endkappe SURFACE14 gen2 mit Öffnung
Farben: weiß, silbern, schwarz, grau
Material: ABS

SURFACE14 ending gen2 with hole
colours: white, silver, black, grey
material: ABS

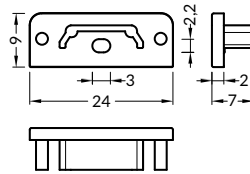

weiß / white
A2970001
silbern / silver
A2970040
schwarz / black
A2970002
grau / grey
A2970022

VERBINDUNGSSTÜCKE / CONNECTORS

Verbindungsstück T 180 Grad
Farben: Rohaluminium
Material: Aluminium

T connector 180 deg
colour: raw aluminium
material: aluminium

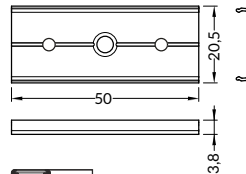

Artikelnummer = 1 Set
Verpackung > siehe bitte Preisliste
INDEX = 1 set
package > check the pricelist

Rohaluminium
raw aluminium
C6990000

Verbinder 90 Grad für SURFACE14
Farben: weiß, eloxiert, schwarz
Material: Aluminium

SURFACE14 connector 90 deg
colours: white, anodized, black
material: aluminium

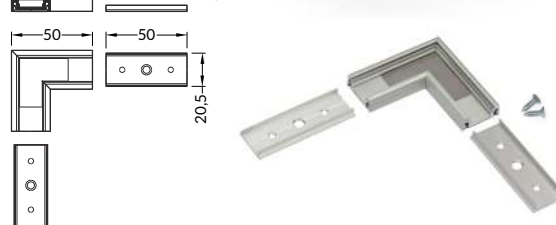

weiß lackiert
white painted
A2990001

eloxiert
anodized
A2990020

schwarz eloxiert
black anodized
A2990021



SMART16 BC3/U4



EIN ÖKONOMISCHES LED PROFIL FÜR LED STREIFEN MIT 16 mm

ECONOMICAL PROFILE FOR 16 mm LED STRIP

- Sockel mit Slick Funktion - eine einfache Montage der Abdeckung
 - zwei Rillen - zwei Niveaus der Befestigung des Halters (mit einem Abstand von der Montagefläche und ohne Abstand)
 - eine homogene Lichtlinie (bei LED Streifen mit 120 leds/m und einer opalen Abdeckung)
 - maximale Breite des LED Streifens 16 mm
-
- SLICK socket - easy assembly technology
 - 2 channels for mounting bracket (with or without mounting surface distance)
 - continuous line of light (when using LED strip 120 P/m and opal cover)
 - maximum width of LED strip: 16 mm



ÄHNLICHES IM ANGEBOT / SIMILAR IN THE OFFER





B Abdeckung **B** einziehbar
B slide cover

C3 Abdeckung **C3** einclipsbar
C3 click cover

U4¹ Halter **U4**
U4 mounting plate

U4² Halter **U4** cone
cone U4 mounting plate

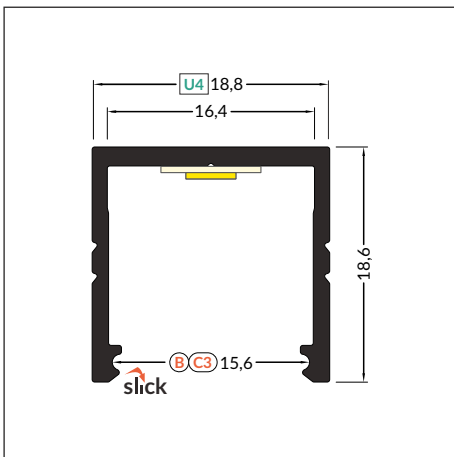
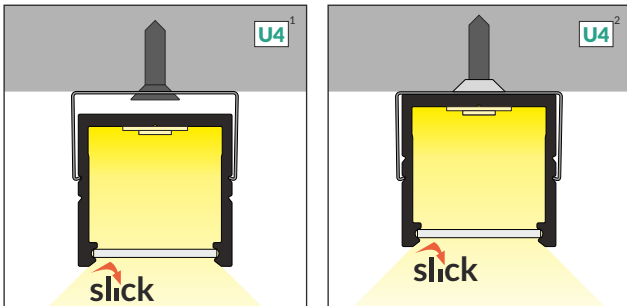
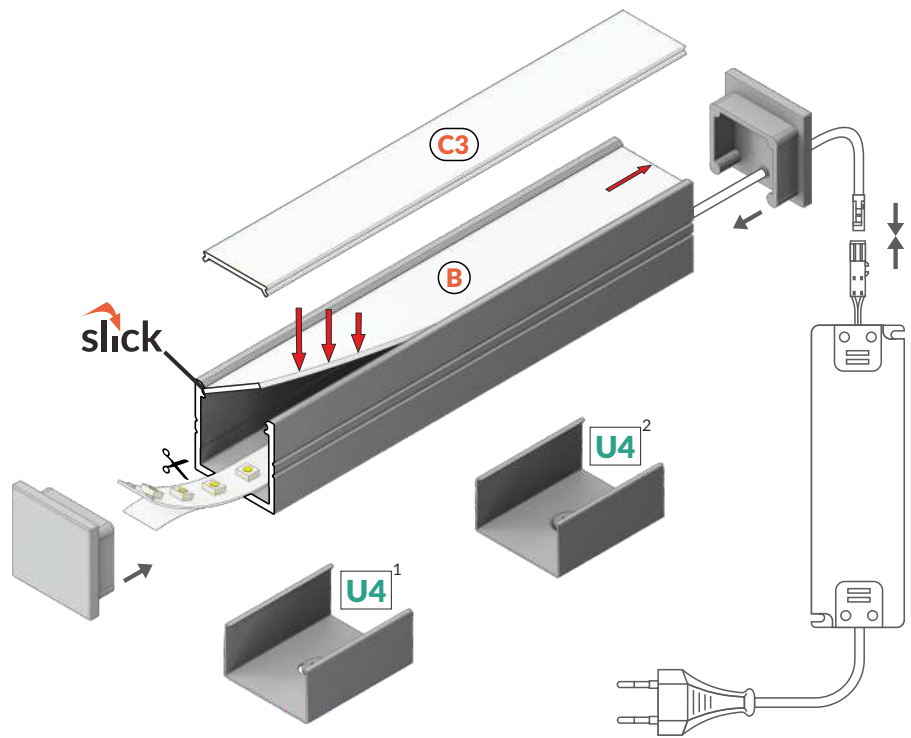

 max 16 mm

 Aufbauprofile
surface



Artikelnummer = 1 Stück, Länge 2.000 mm
Verpackung > siehe bitte Preisliste
INDEX = 1 pc, length 2000 mm
package > check the pricelist

weiß lackiert
white painted
F1020001

eloxiert
anodized
F1020020

schwarz eloxiert
black anodized
F1020021

Rohaluminium
raw aluminium
F1020000

Die zugänglichen Längen: 1000 mm, 2000 mm, 3000 mm, 4000 mm.
Die standardmäßige Toleranz der Länge von Profilen beträgt: +20 mm.
Mehr Informationen >> 1.08.

Available lengths: 1000 mm, 2000 mm, 3000 mm, 4000 mm.
The standard profile length tolerance is +20 mm.
More details >> 1.08.



ABDECKUNG / COVERS

Abdeckung B einschiebbar
Farben: transparent, satiniert, opal
Material: PC, PP, PP

B slide cover
colours: transparent, frosted, opal
material: PC, PP, PP



Achtung! Die Abmessungen des Platzes für die Montage von LED Lichtquelle
Note! Dimensions of the space to install LED source

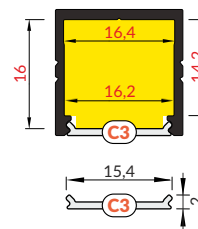
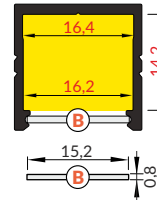

Abdeckung C3 einclipbar
Farben: transparent, opal
Material: PMMA

NEU

C3 click cover
colours: transparent, opal
material: PMMA

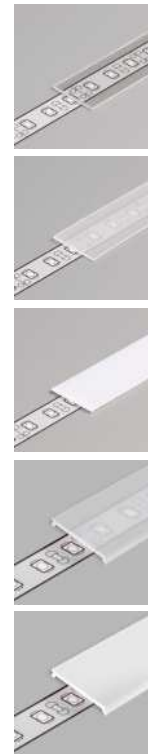

Länge 2.000 mm,
Verpackung > siehe bitte Preisliste
length 2000 mm
package > check the pricelist

B transparent
Artikelnummer = 10 Stück
index = 10 pcs
76250016

B satiniert / B frosted
Artikelnummer = 10 Stück
index = 10 pcs
76250039

B opal
Artikelnummer = 10 Stück
index = 10 pcs
76250038

C3 transparent
Artikelnummer = 1 Stück
index = 1 pc
F1000216

C3 opal
Artikelnummer = 1 Stück
index = 1 pc
F1000238

Die Toleranz der Länge von Abdeckungen beträgt: +20 mm.
Mehr Informationen >> 1.08.

The standard cover length tolerance is +20 mm.
More details >> 1.08.

ENDKAPPEN / ENDINGS

Endkappe SMART16
Farben: weiß, silbern, schwarz, grau
Material: ABS

SMART16 ending
colours: white, silver, black, grey
material: ABS

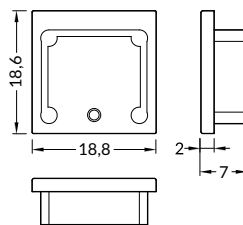

Die Endkappe mit Punkten für das Bohren von Öffnungen.
Ending with marked space to bore the holes.

Artikelnummer = 10 Sets = 10 Stück
Verpackung > siehe bitte Preisliste
INDEX = 10 sets = 20 pcs
package > check the pricelist

weiß / white
F1990001

silbern / silver
F1990040

schwarz / black
F1990002

grau / grey
F1990022

HALTER / MOUNTINGS

Halter U4
Farben: weiß, inox, schwarz
Material: rostfreier Stahl

U4 mounting plate
colours: white, inox, black
material: stainless steel

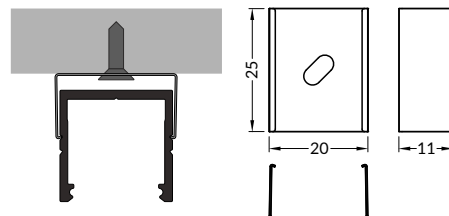

Artikelnummer = 10 Sets = 20 Stück
Verpackung > siehe bitte Preisliste
INDEX = 10 sets = 20 pcs
package > check the pricelist

weiß / white
F1970001

inox
F1970019

schwarz / black
F1970002

Halter U4 cone
Farben: weiß, inox, schwarz
Material: rostfreier Stahl

cone **U4** mounting plate
colours: white, inox, black
material: stainless steel

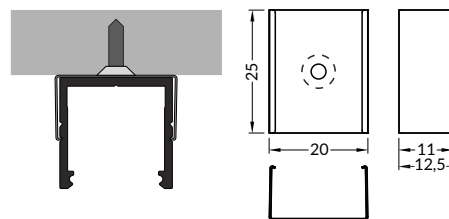

weiß / white
F1980001

inox
F1980019

schwarz / black
F1980002



LINEA20 EF/TY

EINE LEISTUNGSFÄHIGE GEHÄUSE NACH METER

EFFICIENT LUMINAIRE CUT TO SIZE

- mehr als 20 Zubehörteile
 - die Möglichkeit auf der Stromversorgung aufzuhängen
 - die Befestigung der LED Module mit einer Klemme
 - Lichtecken
 - eine homogene Lichtlinie (bei LED Streifen mit 120 leds/m und einer opalen Abdeckung)
 - maximale Breite des LED Streifens 20 mm
-
- over 20 accessories available
 - possibility of suspension along with the power supply
 - LED modules are assembled with extra clamps
 - angled connections illuminated
 - continuous light line (with 120 P/m LED strip and opal cover applied)
 - maximum LED source width: 20 mm



ÄHNLICHES IM ANGEBOT / SIMILAR IN THE OFFER

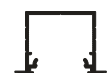

LINEA-IN20
EF/U7



SURFACE14
EF/TY



WIDE24
G/W



VARIO30-01

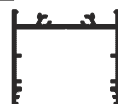

VARIO30-02



E Abdeckung **E** einschiebbar
E slide cover

F Abdeckung **F** einclipsbar
F click cover

E7 Abdeckung **E7** einclipsbar
E7 click cover

Y¹ Halter **Y** flexibel
Y flexible mounting plate

Y² Halter **Y** flexibel cone
cone Y flexible mounting plate

T Halter **T**
T mounting plate

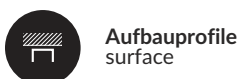
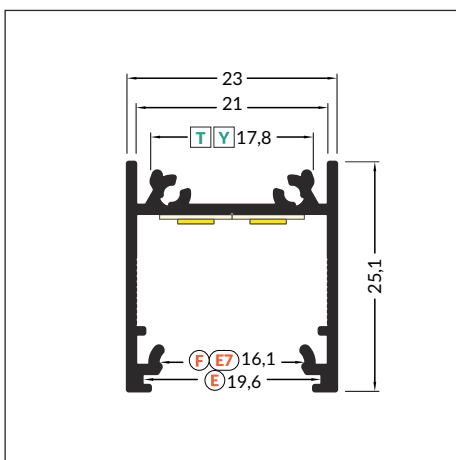
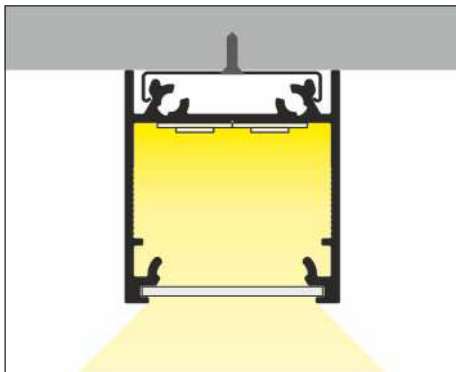
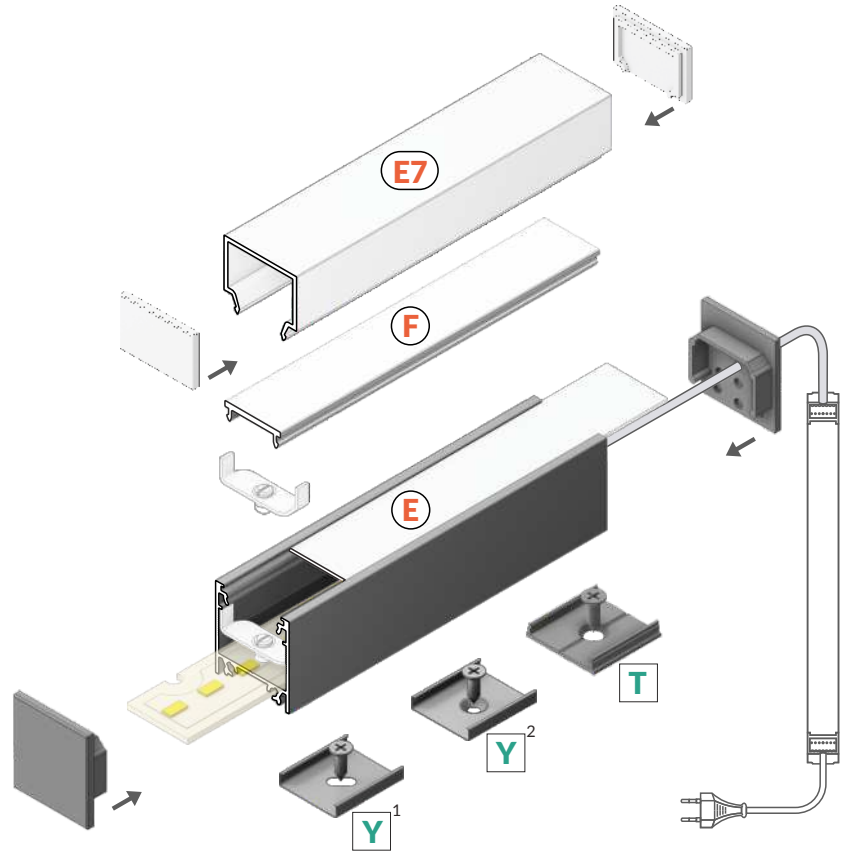

Artikelnummer = 1 Stück, Länge 2.000 mm
Verpackung > siehe bitte Preisliste
INDEX = 1 pc, length 2000 mm
package > check the pricelist

weiß lackiert
white painted
C1020001



eloxiert
anodized
C1020020



schwarz eloxiert
black anodized
C1020021



Rohaluminium
raw aluminium
C1020000

Die zugänglichen Längen: 1000 mm, 2000 mm, 3000 mm, 4000 mm.
Die standardmäßige Toleranz der Länge von Profilen beträgt: +20 mm.
Mehr Informationen >> 1.08.

Available lengths: 1000 mm, 2000 mm, 3000 mm, 4000 mm.
The standard profile length tolerance is +20 mm.
More details >> 1.08.

LINEA20 EF/TY



EINE HOMOGENE LICHTLINIE
Wenn man die Verbindungsstück LINEA20 mit 180° verwendet, kann man eine ästhetische, ununterbrochene Lichtlinie in einer beliebigen Länge erreichen.

CONTINUOUS LIGHT LINE
The LINEA20 180° connector provides an aesthetic, continuous light line of any length.



ABDECKUNG / COVERS

Abdeckung E einziehbar
Farben: transparent, satiniert, opal
Material: PC, PP, PP

E slide cover
colours: transparent, frosted, opal
material: PC, PP, PP



Achtung! Die Abmessungen des Platzes für die Montage von LED Lichtquelle
Note! Dimensions of the space to install LED source

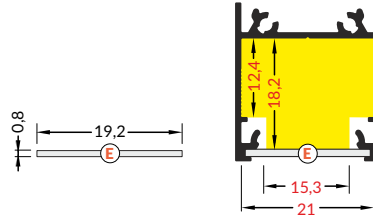

Abdeckung F einclipsbar
Farben: transparent, opal
Material: PMMA

F click cover
colours: transparent, opal
material: PMMA

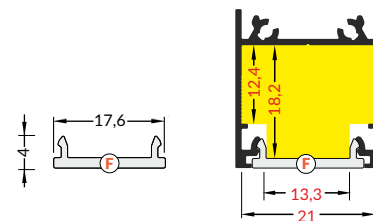

Abdeckung E7 einclipsbar
Farben: opal
Material: PMMA

E7 click cover
colour: opal
material: PMMA

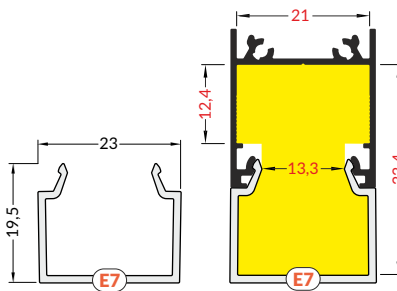

NEU

Länge 2.000 mm,
Verpackung > siehe bitte Preisliste
length 2000 mm
package > check the pricelist

E transparent
Artikelnummer = 10 Stück
index = 10 pcs
A2040016

E satiniert / E frosted
Artikelnummer = 10 Stück
index = 10 pcs
A2040039

E opal
Artikelnummer = 10 Stück
index = 10 pcs
A2040038

F transparent
Artikelnummer = 1 Stück
index = 1 pc
A2060016

F opal
Artikelnummer = 1 Stück
index = 1 pc
A2060038

Rolle, Länge 20 m,
Verpackung > siehe bitte Preisliste
reel length 20 m
package > check the pricelist

F opal
Artikelnummer = 1 Stück
index = 1 pc
A2210038S

Länge 2.000 mm,
Verpackung > siehe bitte Preisliste
length 2000 mm
package > check the pricelist

E7 opal
Artikelnummer = 1 Stück
index = 1 pc
C1080038

Die Toleranz der Länge von Abdeckungen beträgt: +20 mm.
Mehr Informationen >> 1.08.
The standard cover length tolerance is +20 mm.
More details >> 1.08.

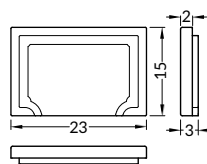

Artikelnummer = 1 Set = 2 Stück
Verpackung > siehe bitte Preisliste
INDEX = 1 set = 2 pcs
package > check the pricelist

Endkappe E7 opal
E7 opal ending
C1840038



MONTAGETEIL FÜR LED / LED MOUNTING

Montageteil LED für LINEA20
Material: Aluminium

LINEA20 LED mounting
material: aluminium

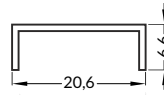

Artikelnummer = 1 Stück, Länge 2.000 mm
Verpackung > siehe bitte Preisliste
INDEX = 1 pc, length 2000 mm
package > check the pricelist

Rohaluminium
raw aluminium
C6060000

Die zugänglichen Längen: 1000 mm, 2000 mm, 3000 mm, 4000 mm. Die standardmäßige Toleranz der Länge von Profilen beträgt: +20 mm. Mehr Informationen >> 1.08.

Available lengths: 1000 mm, 2000 mm, 3000 mm, 4000 mm. The standard profile length tolerance is +20 mm. More details >> 1.08.

LEUCHTEFFEKT / LIGHTING EFFECT

LED Montageteil für LINEA20 + LED Klemme LINEA20-1 / LINEA20 LED mounting + LINEA20-1 LED clamp

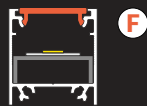

Leuchteffekt ohne die Einschleibplatte für LED bei dem Profil LINEA20 zu verwenden / Lighting effect without LINEA20 LED mounting

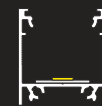



KLEMME / CLAMP

LED Klemme LINEA20
Farben: weiß
Material: Stahl, Kunststoff

LINEA20 LED clamp
colour: white
material: painted steel, plastic

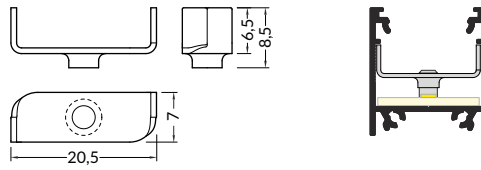

Artikelnummer = 1 Set = 2 Stück
Verpackung > siehe bitte Preisliste
INDEX = 1 set = 2 pcs
package > check the pricelist

weiß / white
C6940001

LED Klemme LINEA20-1
Farben: weiß
Material: Stahl, Kunststoff

LINEA20-1 LED clamp
colour: white
material: painted steel, plastic

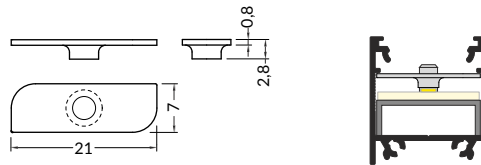

weiß / white
C6930001

ENDKAPPEN / ENDINGS

Endkappe LINEA20
Farben: weiß, silbern, schwarz, grau
Material: ABS

LINEA20 ending
colours: white, silver, black, grey
material: ABS

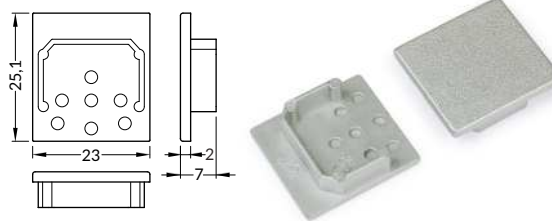

Artikelnummer = 10 Sets = 20 Stück
Verpackung > siehe bitte Preisliste
INDEX = 10 sets = 20 pcs
package > check the pricelist

weiß / white
C1940001
silbern / silver
C1940040
schwarz / black
C1940002
grau / grey
C1940022



Die Endkappe mit Punkten für das Bohren von Öffnungen.
Es besteht die Möglichkeit spezielle Schrauben zu kaufen.
Ending with marked space to bore the holes.
Possibility of buying dedicated screws.

Endkappe LINEA20-E7
Farben: weiß, silbern, schwarz, grau
Material: ABS

LINEA20-E7 ending
colours: white, silver, black, grey
material: ABS

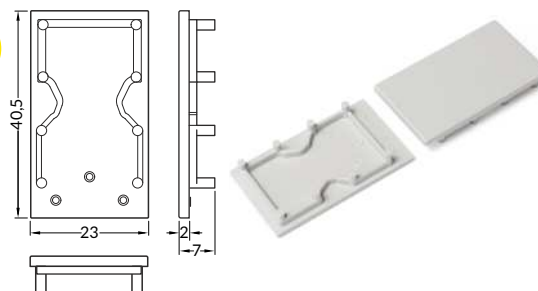

weiß / white
C1999901
silbern / silver
C1999940
schwarz / black
C1999902
grau / grey
C1999922



Die Endkappe mit Punkten für das Bohren von Öffnungen.
Es besteht die Möglichkeit spezielle Schrauben zu kaufen.
Ending with marked space to bore the holes.
Possibility of buying dedicated screws.

Schrauben für die Endkappen
Farben: weiß, silbern, schwarz, inox

screws for LED endings
colours: white, silver, black, inox



Artikelnummer = 10 Sets = 40 Stück
Verpackung > siehe bitte Preisliste
INDEX = 10 sets = 40 pcs
package > check the pricelist

weiß / white
B1900001
silbern / silver
B1900040
schwarz / black
B1900002
inox
B1900019

LINEA20 EF/TY

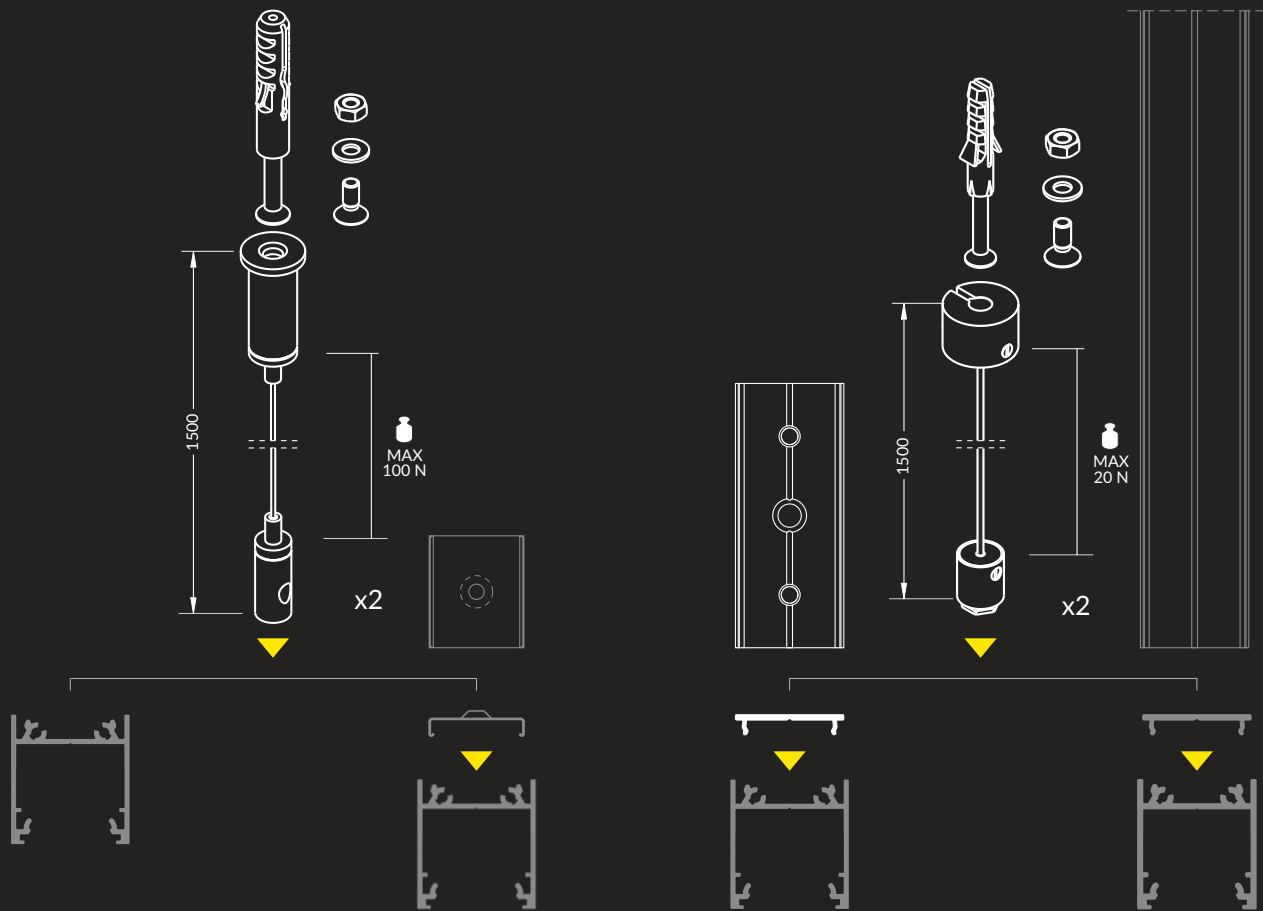

ABHÄNGUNG FÜR LED PROFIL-HALTER 1500
Die Anpassung an die flexiblen Halter ermöglicht eine schnelle und einfache Montage der Gehäuse. Möglich ist auch die Montage direkt an das Profil.

SLING FOR LED MOUNTING 1500
Compatible with flexible mounting plates, allows fast and easy assembly of the luminaire. Possibility of direct mounting to the profile.

STROMLEITENDE ABHÄNGUNG SELV 50 V 1500
Es sichert schlichtes Aussehen - ohne die Notwendigkeit zusätzliche Kabel durchzuführen.

SELV SLING 50 V 1500
It provides a minimalistic look - no additional wires required.

Bei dem Anwenden von dem Profil FIX16 bildet man eine ästhetische, vom Oben geschlossene Gehäuse.

Using FIX16 profile creates an aesthetic, closed from the top, luminaire.

In dem Profil FIX16 soll man die Montagelöcher von $\varnothing 5$ mm bohren
Drill $\varnothing 5$ mm mounting holes in FIX16



HALTER / MOUNTINGS

Halter Y flexibel
Farben: inox
Material: rostfreier Stahl
Y flexible mounting plate
colour: inox
material: stainless steel

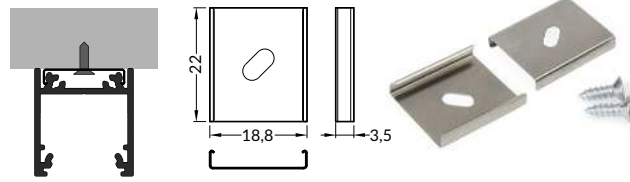

Artikelnummer = 10 Sets = 20 Stück
Verpackung > siehe bitte Preisliste
INDEX = 10 sets = 20 pcs
package > check the pricelist

inox
A2090019

Halter Y flexibel cone
Farben: inox
Material: rostfreier Stahl
cone Y flexible mounting plate
colour: inox
material: stainless steel

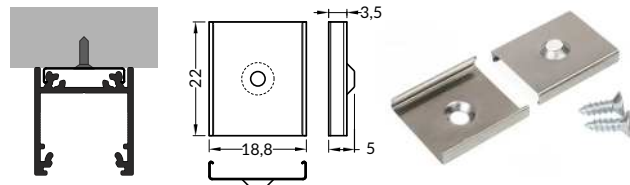

inox
A2130019

Halter T
Farben: Rohaluminium
Material: Aluminium
T mounting plate
colour: raw aluminium
material: aluminium

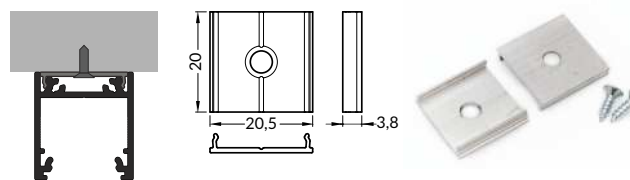

Rohaluminium
raw aluminium
C6960000

ALUMINIUMABDECKPLATTE / ALUMINIUM COVER

LED Profil FIX16
Farben: weiß, eloxiert, schwarz, Rohaluminium
Material: Aluminium
LED profile FIX16
colours: white, anodized, black, raw aluminium
material: aluminium

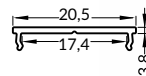

Artikelnummer = 1 Stück, Länge 2.000 mm
Verpackung > siehe bitte Preisliste
INDEX = 1 pc, length 2000 mm
package > check the pricelist

weiß lackiert
white painted
C6020001

eloxiert
anodized
C6020020

schwarz eloxiert
black anodized
C6020021

Rohaluminium
raw aluminium
C6020000

Die zugänglichen Längen: 1000 mm, 2000 mm, 3000 mm, 4000 mm.
Die standardmäßige Toleranz der Länge von Profilen beträgt: +20 mm. Mehr Informationen >> 1.08.
Available lengths: 1000 mm, 2000 mm, 3000 mm, 4000 mm.
The standard profile length tolerance is +20 mm. More details >> 1.08.

ABHÄNGUNG / SLING

Abhängung SELV 50V 1500
Farben: weiß, silbern, schwarz
SELV sling 50 V 1500
colours: white, silver, black



Artikelnummer = 1 Set = 2 Stück
Verpackung > siehe bitte Preisliste
INDEX = 1 set = 2 pcs
package > check the pricelist

weiß / white
67120001

silbern / silver
67120040

schwarz / black
67120002

Abhängung für LED Profil-Halter 1500
Farben: Chrom
sling for LED mounting 1500
colour: chrome



Chrom / chrome
67140003

LINEA20 EF/TY

VERBINDUNGSMÖGLICHKEITEN CONNECTION POSSIBILITY



60°



90°



120°

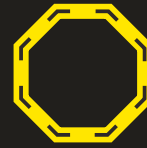

135°

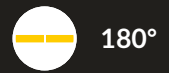

180°

ECKVERBINDER

Dank den Eckverbindern mit fünf unterschiedlichen Winkeln (60° / 90° / 120° / 135° / 180°) möglich ist die Bildung von vielen unterschiedlichen Lichtvarianten ohne das Profil auf Gehrung zuschneiden müssen.

Gebogene Verbindungsstücke ermöglichen das Verbinden von zwei Profilen in zwei Ebenen, unter zwei Winkeln; dem inneren Winkel von 90° und dem äußeren Winkel von 270°.

ANGULAR CONNECTORS

Thanks to five different angle connectors (60° / 90° / 120° / 135° / 180°) it is possible to create many various lighting systems – with no need to cut the profile at an angle.

Bent connectors allows to connect profiles in two planes, at two angles: 90° on the inside and 270° on the outside.



Ein Element aus durchsichtiger Kunststoff sichert die Stabilisierung der Verbindung und gleichzeitig lässt das Licht durch. Diese Lösung ermöglicht das Leuchten der Gehäuse auf der ganzen Fläche - auch in den Ecken.

The component made of clear fabric provides secure connection, letting light through at the same time. Thanks to that, the luminaire can illuminate on the entire surface of the cover – even in the corners.



VERBINDUNGSTÜCKE / CONNECTORS

Verbinder 60 Grad für LINEA20
Farben: weiß, eloxiert, schwarz
Material: Aluminium, Polycarbonat

LINEA20 connector 60 deg
colours: white, anodized, black
material: aluminium, polycarbonate

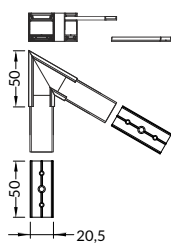

Artikelnummer = 1 Set
Verpackung > siehe bitte Preisliste
INDEX = 1 set
package > check the pricelist

weiß lackiert / white painted
C1850001

eloxiert / anodized
C1850020

schwarz eloxiert / black anodized
C1850002

Verbinder 90 Grad für LINEA20
Farben: weiß, eloxiert, schwarz
Material: Aluminium, Polycarbonat

LINEA20 connector 90 deg
colours: white, anodized, black
material: aluminium, polycarbonate

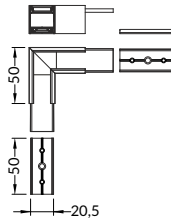

weiß lackiert / white painted
C1860001

eloxiert / anodized
C1860020

schwarz eloxiert / black anodized
C1860002

Verbinder 90 Grad für LINEA20 gebogen
Farben: weiß, eloxiert, schwarz
Material: Aluminium, Polycarbonat

LINEA20 connector 90 deg bent
colours: white, anodized, black
material: aluminium, polycarbonate

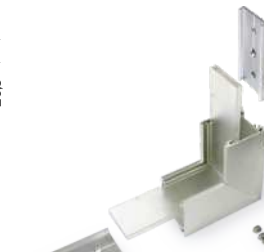
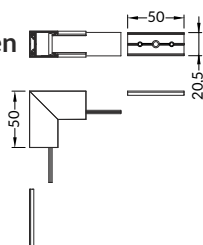

weiß lackiert / white painted
C1870001

eloxiert / anodized
C1870020

schwarz eloxiert / black anodized
C1870002

Verbinder 120 Grad für LINEA20
Farben: weiß, eloxiert, schwarz
Material: Aluminium, Polycarbonat

LINEA20 connector 120 deg
colours: white, anodized, black
material: aluminium, polycarbonate

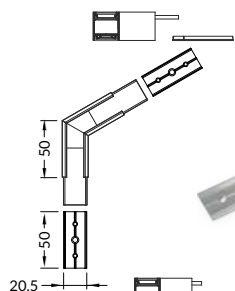

weiß lackiert / white painted
C1880001

eloxiert / anodized
C1880020

schwarz eloxiert / black anodized
C1880002

Verbinder 135 Grad für LINEA20
Farben: weiß, eloxiert, schwarz
Material: Aluminium, Polycarbonat

LINEA20 connector 135 deg
colours: white, anodized, black
material: aluminium, polycarbonate

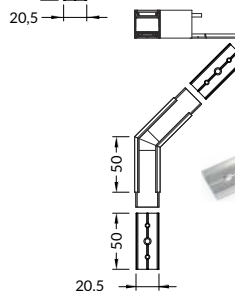

weiß lackiert / white painted
C1890001

eloxiert / anodized
C1890020

schwarz eloxiert / black anodized
C1890002

Verbinder 180 Grad für LINEA20
Material: Aluminium, Polycarbonat

LINEA20 connector 180 deg
material: aluminium, polycarbonate

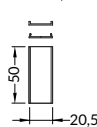

C1900000

Verbinder 270 Grad für LINEA20 gebogen
Farben: weiß, eloxiert, schwarz
Material: Aluminium, Polycarbonat

LINEA20 connector 270 deg bent
colours: white, anodized, black
material: aluminium, polycarbonate

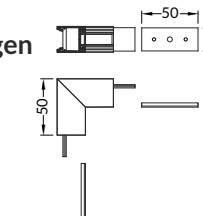

weiß lackiert / white painted
C1910001

eloxiert / anodized
C1910020

schwarz eloxiert / black anodized
C1910002

LINEA20 EF/TY





PENDELLEUCHE

Dank vielen Zubehörteilen kann man das Profil für viele Anwendungen einsetzen. Die Abhängung SELV 50 V 1500 und das Abdeckprofil FIX16 ermöglicht das Bauen einer Pendelleuchte mit einem kleinen Durchmesser, aber die viel, starkes Licht gibt.

PENDANT LUMINAIRE

Thanks to wide range of profile accessories it could be applied in many arrangements. SELV sling 50 V 1500 and FIX16 closing profile allows to create pendant luminaire with a small intersection, but strong light.

EIN BREITES ALUMINIUMPROFIL FÜR AUFBAU

WIDE, ALUMINIUM, SURFACE PROFILE

- man kann gleichzeitig drei LED Streifen mit 8 mm Breite verwenden
- Sockel mit Slick Funktion
- maximale Breite des LED Streifens 24 mm
- possibility of installing 3 8 mm LED strips
- Slick socket
- maximum LED strip width: 24 mm



ÄHNLICHES IM ANGEBOT / SIMILAR IN THE OFFER





G Abdeckung **G** einschiebbar
G slide cover

W Halter **W** flexibel cone
cone **W** flexible mounting plate

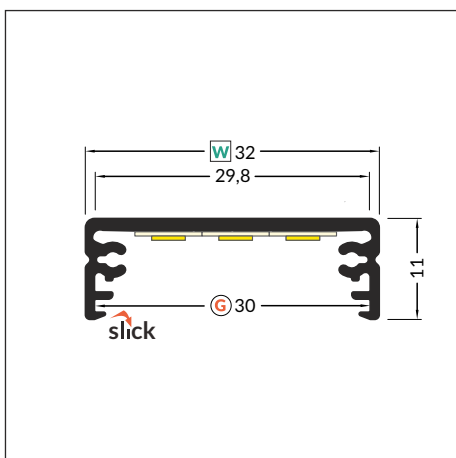
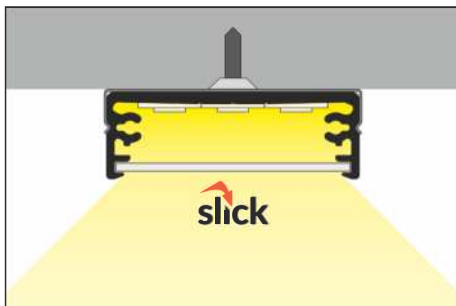
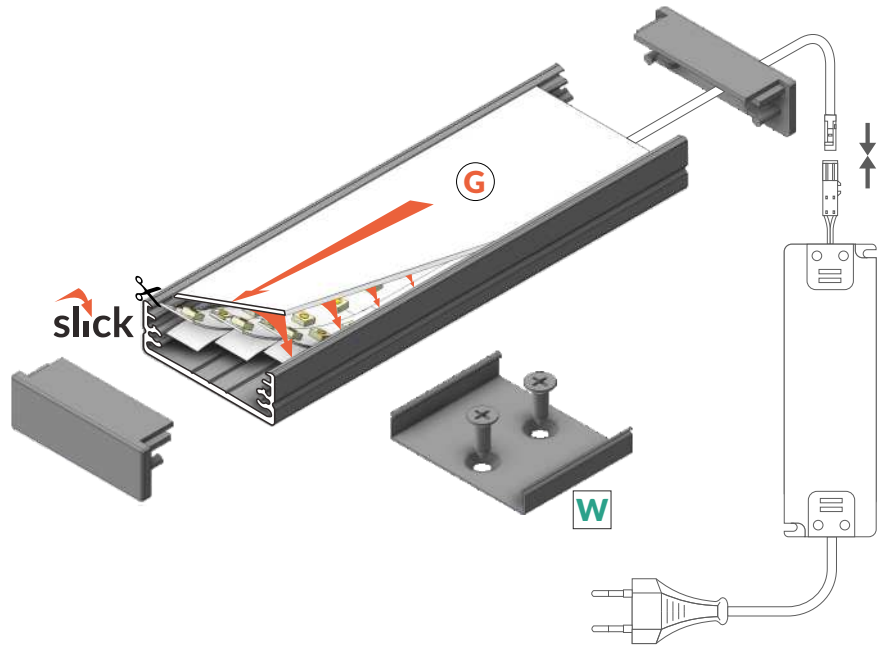

 max 24 mm

 Aufbauprofile
surface



Artikelnummer = 1 Stück, Länge 2.000 mm
Verpackung > siehe bitte Preisliste
INDEX = 1 pc, length 2000 mm
package > check the pricelist

weiß lackiert
white painted
84030001



eloxiert
anodized
84030020



schwarz eloxiert
black anodized
84030021



Rohaluminium
raw aluminium
84030000

Die zugänglichen Längen: 1000 mm, 2000 mm, 3000 mm, 4000 mm.
Die standardmäßige Toleranz der Länge von Profilen beträgt: +20 mm.
Mehr Informationen >> 1.08.

Available lengths: 1000 mm, 2000 mm, 3000 mm, 4000 mm.
The standard profile length tolerance is +20 mm.
More details >> 1.08.



ABDECKUNG / COVERS

Abdeckung **G** einziehbar
Farben: transparent, satiniert, opal
Material: PC, PP, PP

G slide cover
colours: transparent, frosted, opal
material: PC, PP, PP



Achtung! Die Abmessungen des Platzes für die Montage von LED Lichtquelle
Note! Dimensions of the space to install LED source

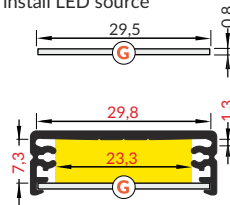

Länge 2.000 mm,
Verpackung > siehe bitte Preisliste
length 2000 mm
package > check the pricelist

G transparent
Artikelnummer = 10 Stück
index = 10 pcs
84070016

G satiniert / **G** frosted
Artikelnummer = 10 Stück
index = 10 pcs
84070039

G opal
Artikelnummer = 10 Stück
index = 10 pcs
84070038

Die Toleranz der Länge von Abdeckungen beträgt: +20 mm.
Mehr Informationen >> 1.08.
The standard cover length tolerance is +20 mm.
More details >> 1.08.

ENDKAPPEN / ENDINGS

Endkappe WIDE24
Farben: weiß, silbern, schwarz, grau
Material: ABS
WIDE24 ending
colours: white, silver, black, grey
material: ABS

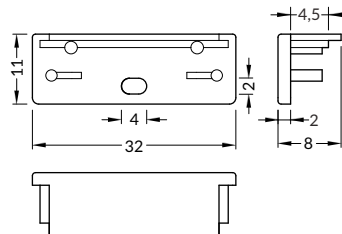

Artikelnummer = 10 Sets = 20 Stück
Verpackung > siehe bitte Preisliste
INDEX = 10 sets = 20 pcs
package > check the pricelist

weiß / white
84040001
silbern / silver
84040040
schwarz / black
84040002
grau / grey
84040022

Endkappe WIDE24 mit Öffnung
Farben: weiß, silbern, schwarz, grau
Material: ABS
WIDE24 ending with hole
colours: white, silver, black, grey
material: ABS



weiß / white
84300001
silbern / silver
84300040
schwarz / black
84300002
grau / grey
84300022

HALTER / MOUNTINGS

Halter **W** flexibel cone
Farben: weiß, inox, schwarz
Material: rostfreier Stahl

cone **W** flexible mounting plate
colour: white, inox, black
material: stainless steel

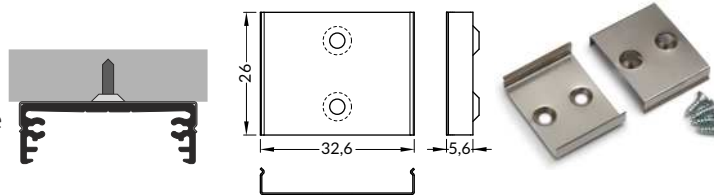

Artikelnummer = 10 Sets = 20 Stück
Verpackung > siehe bitte Preisliste
INDEX = 10 sets = 20 pcs
package > check the pricelist

weiß / white
84510001
inox
84510019
schwarz / black
84510002

Halter WIDE24 einfach
Material: verzinkter Stahl

WIDE24 simple holder
material: zinc coated steel

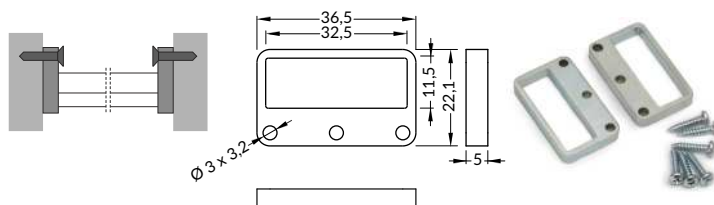

Artikelnummer = 1 Set = 2 Stück
Verpackung > siehe bitte Preisliste
INDEX = 1 set = 2 pcs
package > check the pricelist

verzinkt
zinc coated
84220030



ABHÄNGUNG / SLING

Abhängung SELV 50V 1500
Farben: weiß, silbern, schwarz

SELV sling 50 V 1500
colours: white, silver, black

Abhängung für LED Profil-Halter 1500
Farben: Chrom

sling for LED mounting 1500
colour: chrome



Artikelnummer = 1 Set = 2 Stück
Verpackung > siehe bitte Preisliste
INDEX = 1 set = 2 pcs
package > check the pricelist

weiß / white
67120001

silbern / silver
67120022

schwarz / black
67120002

Chrom / chrome
67140003





2020

LED PROFILE
LED PROFILES

EINBAUPROFILE / RECESSED



FLAT8 H/UX

EIN FLACHES EINBAUPROFIL, DAS EINEN ZERSTREUTEN LICHTSCHEIN EMITIERT
FLAT RECESSED PROFILE EMITTING DIFFUSED LIGHT GLOW

- dekorative Beleuchtung
 - ein parabelförmiger Reflektor - gleiches, weiches und zerstreutes Licht
 - ein flaches Profil, das in die Dicke der Rigipsplatte passt, die Montage gelingt ohne in den Rahmenbau einzugreifen
 - die Montage an die Möbel, Wände, in die Sockel mit Hilfe von Haltern (durch Einclipsen) oder direkt (durch das Zuschrauben oder Einkleben)
 - maximale Breite des LED Streifens 8 mm
-
- decorative illumination
 - a parabolic, reflecting element - even, smooth, diffused light
 - a flat profile, designed to fit into plasterboards - installation without interference in the frame construction
 - mounted to furniture, walls, pedestals with holders (click-in) or directly (with screws, adhesive tape or glue)
 - maximum LED strip width: 8 mm



ÄHNLICHES IM ANGEBOT / SIMILAR IN THE OFFER

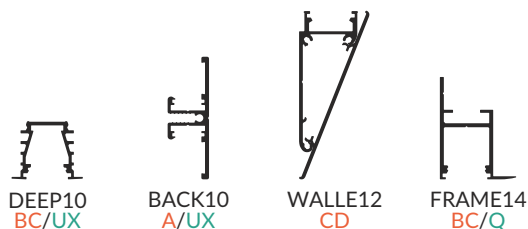



H Abdeckung **H** einziehbar
H slide cover

U¹ Halter **U** flexibel
U flexible mounting plate

U² Halter **U** flexibel cone
cone U flexible mounting plate

X¹ Halter **X**
X mounting plate

X² Halter **X** Feder
spring X mounting plate

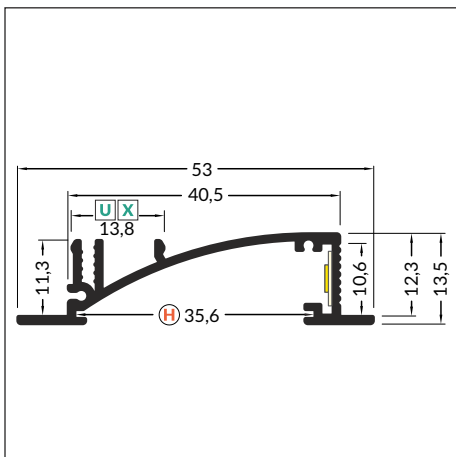
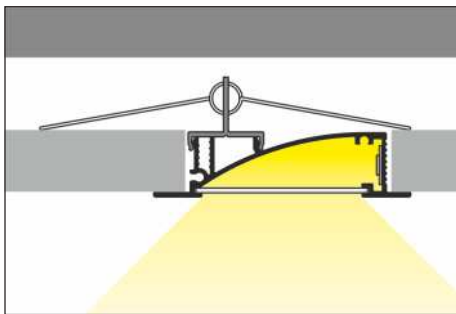
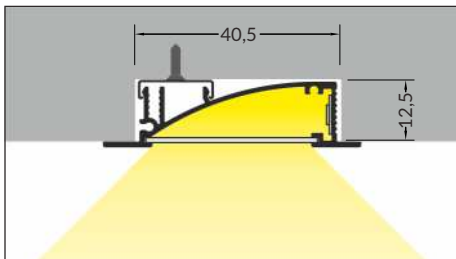
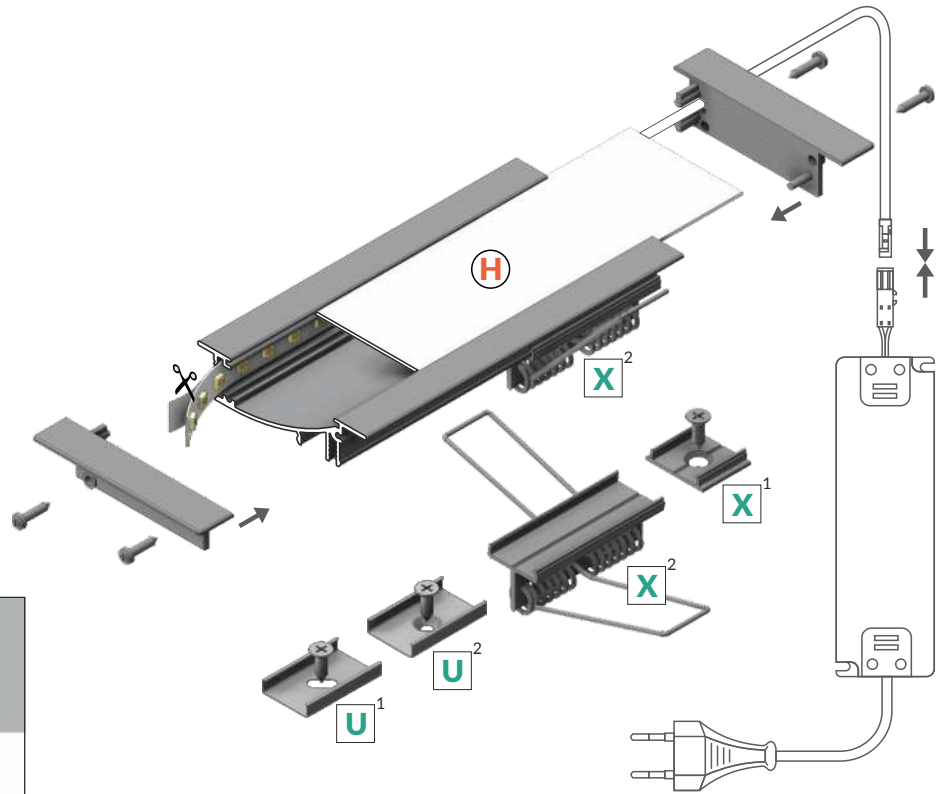

 max 8 mm

 Einbauprofile
recessed



Artikelnummer = 1 Stück, Länge 2.000 mm
Verpackung > siehe bitte Preisliste
INDEX = 1 pc, length 2000 mm
package > check the pricelist

weiß lackiert
white painted
23050001



eloxiert
anodized
23050020



schwarz eloxiert
black anodized
23050021



Rohaluminium
raw aluminium
23050000

Die zugänglichen Längen: 1000 mm, 2000 mm, 3000 mm, 4000 mm.
Die standardmäßige Toleranz der Länge von Profilen beträgt: +20 mm.
Mehr Informationen >> 1.08.

Available lengths: 1000 mm, 2000 mm, 3000 mm, 4000 mm.
The standard profile length tolerance is +20 mm.
More details >> 1.08.



ABDECKUNG / COVERS

Abdeckung **H** einschiebbar
Farben: transparent, satiniert, opal
Material: PC, PP, PP

H slide cover
colours: transparent, frosted, opal
material: PC, PP, PP



Achtung! Die Abmessungen des Platzes für die Montage von LED Lichtquelle
Note! Dimensions of the space to install LED source

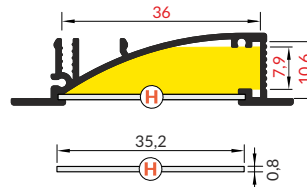

Länge 2.000 mm,
Verpackung > siehe bitte Preisliste
length 2000 mm
package > check the pricelist

H transparent
Artikelnummer = 10 Stück
index = 10 pcs
23080016

H satiniert / H frosted
Artikelnummer = 10 Stück
index = 10 pcs
23080039

H opal
Artikelnummer = 10 Stück
index = 10 pcs
23080038

Die Toleranz der Länge von Abdeckungen beträgt: +20 mm.
Mehr Informationen >> 1.08.

The standard cover length tolerance is +20 mm.
More details >> 1.08.

ENDKAPPEN / ENDINGS

Endkappe **FLAT8** mit Öffnung
Farben: weiß, silbern, schwarz, grau
Material: ABS

FLAT8 ending with hole
colours: white, silver, black, grey
material: ABS

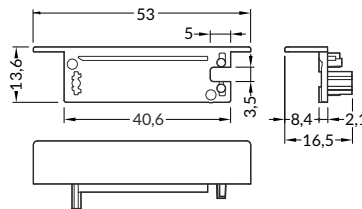

Artikelnummer = 10 Sets = 20 Stück
Verpackung > siehe bitte Preisliste
INDEX = 10 sets = 20 pcs
package > check the pricelist

weiß / white
23110001

silbern / silver
23110040

schwarz / black
23110002

grau / grey
23110022

HALTER / MOUNTINGS

Halter **U** flexibel
Farben: inox
Material: rostfreier Stahl

U flexible mounting plate
colour: inox
material: stainless steel

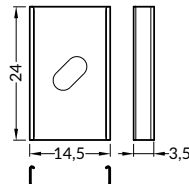
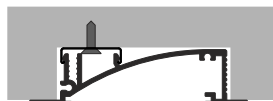

Artikelnummer = 10 Sets = 20 Stück
Verpackung > siehe bitte Preisliste
INDEX = 10 sets = 20 pcs
package > check the pricelist

inox
76380000

Halter **U** flexibel cone
Farben: inox
Material: rostfreier Stahl

cone **U** flexible mounting plate
colour: inox
material: stainless steel

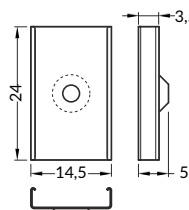
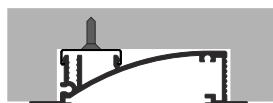

inox
76620000

Halter **X**
Farben: Rohaluminium
Material: Aluminium

X mounting plate
colour: raw aluminium
material: aluminium

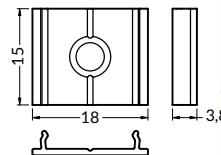
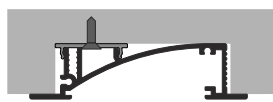

Rohaluminium
raw aluminium
76260000

Halter **X** Feder
Farben: Rohaluminium
Material: Aluminium

spring **X** mounting plate
colour: raw aluminium
material: aluminium

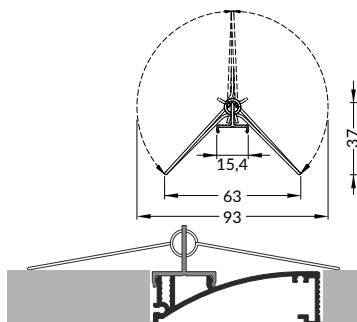

Artikelnummer = 1 Stück
Verpackung > siehe bitte Preisliste
INDEX = 1 pc
package > check the pricelist

Rohaluminium
raw aluminium
23130000



VERBINDUNGSTÜCKE / CONNECTORS

Verbindungsstück X 180 Grad
Farben: Rohaluminium
Material: Aluminium

X connector 180 deg
colour: raw aluminium
material: aluminium

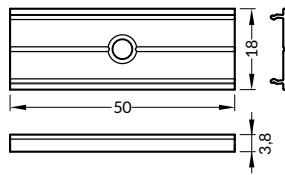

Artikelnummer = 1 Set
Verpackung > siehe bitte Preisliste
INDEX = 1 set
package > check the pricelist

Rohaluminium
raw aluminium
76350000



HI8 C1

EINE SCHMALE LICHTLINIE

THIN LINE OF LIGHT

- dekorative Beleuchtung
 - für die Montage in dem Rand von Platten, Treppen
 - an die Montagefläche angepasst
 - sichtbar ist nur die leuchtende Oberfläche der Abdeckung
 - kleine Abmessungen
 - maximale Breite des LED Streifens 8 mm
-
- decorative illumination
 - for counter edges, steps
 - flushes with mounting surface
 - only enlight surface of the cover is visible
 - miniature dimensions
 - maximum width of LED strip: 8 mm



ÄHNLICHES IM ANGEBOT / SIMILAR IN THE OFFER

SLASH8

FLOOR12
K/U

SMART-IN10
AC2/Z



C1 Abdeckung C1 einclipsbar
C1 click cover

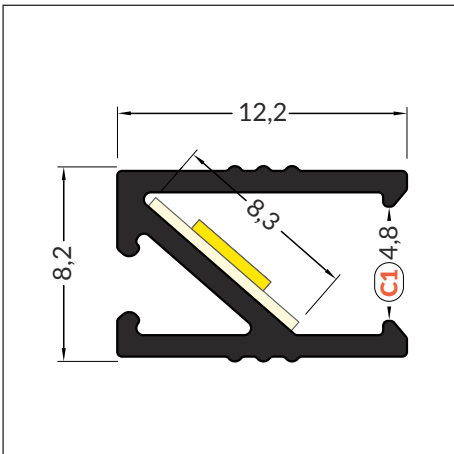
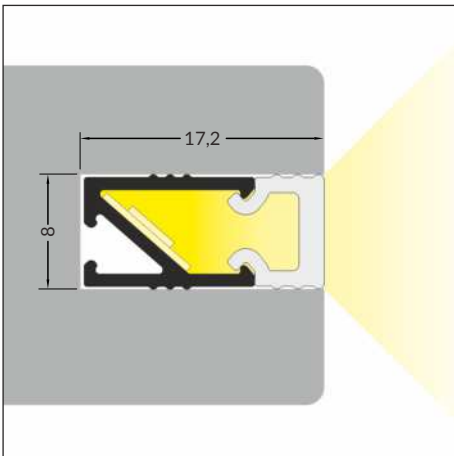
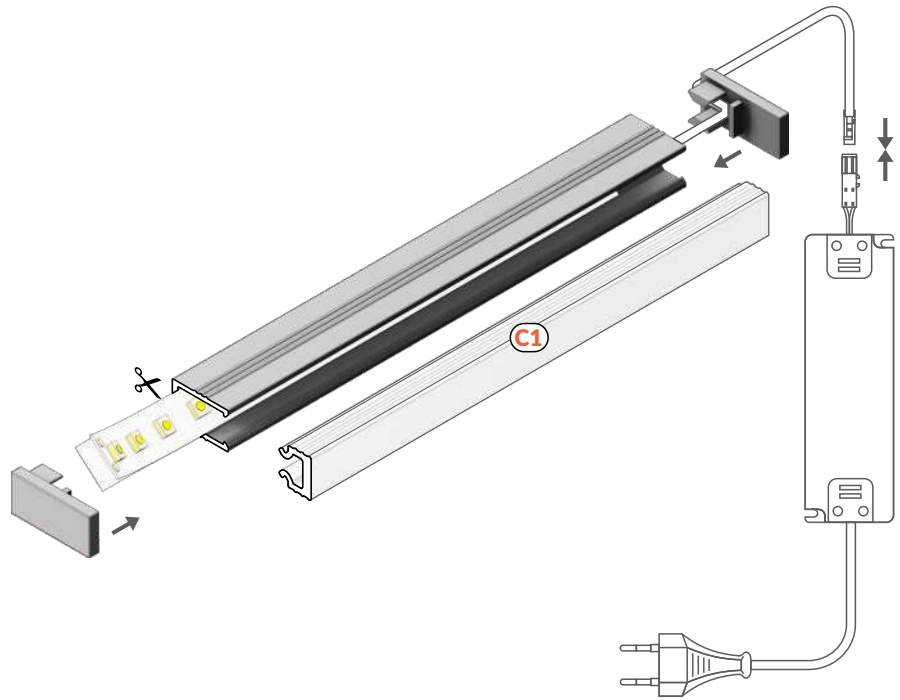

Artikelnummer = 1 Stück, Länge 2.000 mm
Verpackung > siehe bitte Preisliste
INDEX = 1 pc, length 2000 mm
package > check the pricelist

eloxiert
anodized
H8020020

Die zugänglichen Längen: 1000 mm, 2000 mm, 3000 mm, 4000 mm.
Die standardmäßige Toleranz der Länge von Profilen beträgt: +20 mm.
Mehr Informationen >> 1.08.

Available lengths: 1000 mm, 2000 mm, 3000 mm, 4000 mm.
The standard profile length tolerance is +20 mm.
More details >> 1.08.



max 8 mm



Einbauprofile
recessed



ABDECKUNG / COVERS

Abdeckung **C1** einclipsbar
Farben: opal
Material: PMMA

C1 click cover
colours: opal
material: PMMA



Achtung! Die Abmessungen des Platzes für die Montage von LED Lichtquelle
Note! Dimensions of the space to install LED source

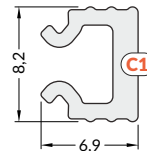
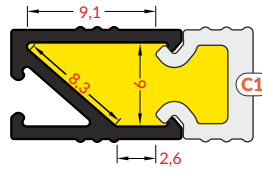

Länge 2.000 mm,
Verpackung > siehe bitte Preisliste
length 2000 mm
package > check the pricelist

C1 opal
Artikelnummer = 1 Stück
index = 1 pc
H8060038

Die Toleranz der Länge von Abdeckungen beträgt: +20 mm.
Mehr Informationen >> 1.08.
The standard cover length tolerance is +20 mm.
More details >> 1.08.

ENDKAPPEN / ENDINGS

Endkappe HI8
Farben: silbern, grau, opal
Material: ABS, ABS, PMMA
HI8 ending
colours: silver, grey, opal
material: ABS, ABS, PMMA

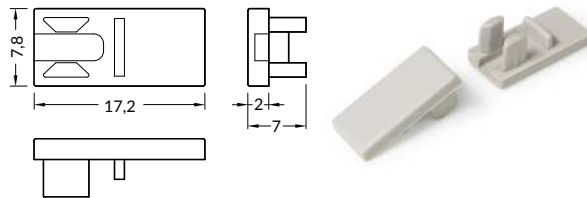

Artikelnummer = 10 Sets = 20 Stück
Verpackung > siehe bitte Preisliste
INDEX = 10 sets = 20 pcs
package > check the pricelist

silbern / silver
H8990040

grau / grey
H8990022

opal
H8990038



SLASH8

NEU

SEHR DÜNNE LICHTLINIE

STRING OF LIGHT

- einfache Montage des LED Streifens
 - Montage in einem kleinen Spalt 5x14 mm
 - Möglichkeit der Montage nach einem Bogen (Mindestbiegeradius 25 cm)
 - eine homogene Lichtlinie (bei LED Streifen mit 120 leds/m)
 - Breite des LED Streifens 8 mm
-
- easy installation of the LED strip
 - installation in a small gap 5x14 mm
 - possibility of installation in an arc (minimum bending radius 25 cm)
 - continous line of light when using 120 P/m LED strip
 - width of LED strip: 8 mm



ÄHNLICHES IM ANGEBOT / SIMILAR IN THE OFFER

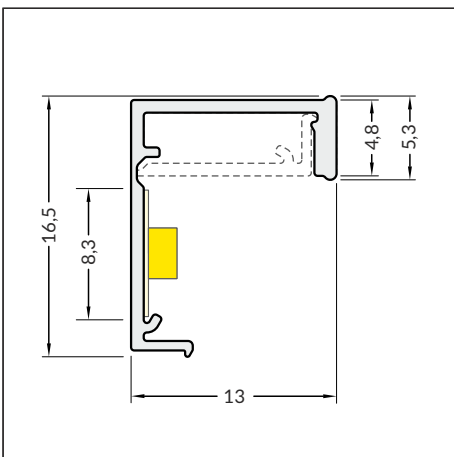
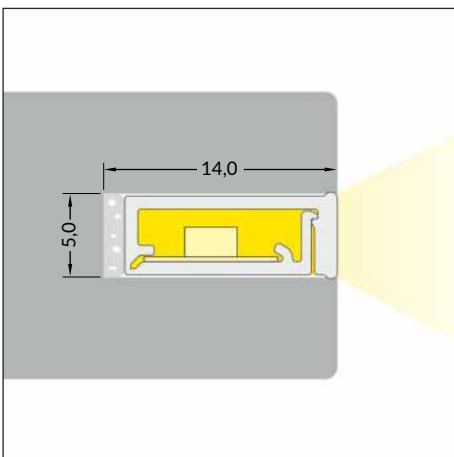
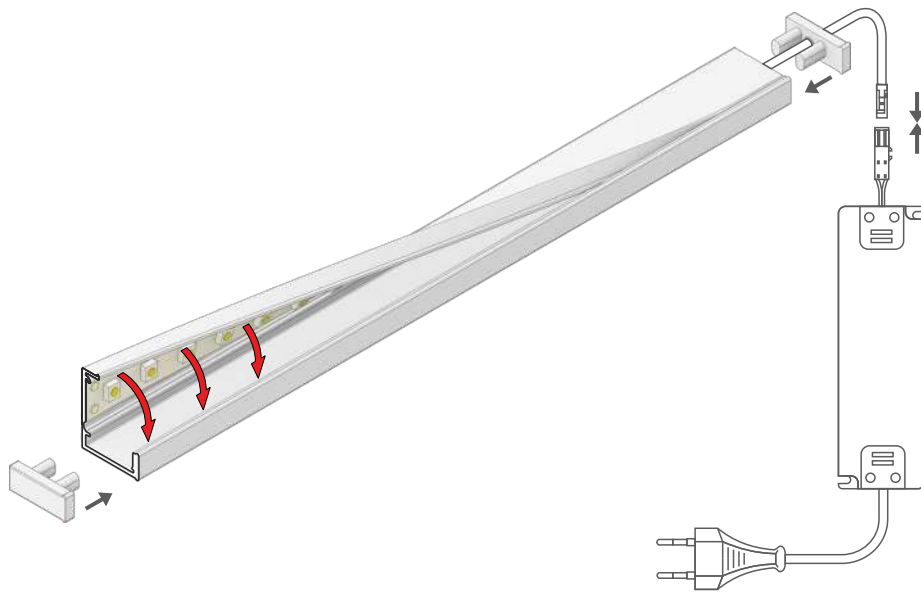

Artikelnummer = 1 Stück, Länge 2.000 mm
Verpackung > siehe bitte Preisliste
INDEX = 1 pc, length 2000 mm
package > check the pricelist

opal
G5000220

Die zugänglichen Längen: 1000 mm, 2000 mm, 3000 mm, 4000 mm.
Die standardmäßige Toleranz der Länge von Profilen beträgt: +20 mm.
Mehr Informationen >> 1.08.

Available lengths: 1000 mm, 2000 mm, 3000 mm, 4000 mm.
The standard profile length tolerance is +20 mm.
More details >> 1.08.



Achtung! Die Abmessungen des Platzes für die Montage von LED Lichtquelle
Note! Dimensions of the space to install LED source

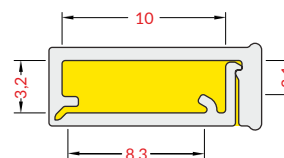

8 mm



Einbauprofile
recessed



ENDKAPPEN / ENDINGS

Endkappe SLASH8
Farben: opal
Material: PMMA
SLASH8 ending
colour: opal
material: PMMA

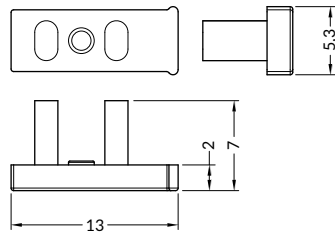

Artikelnummer = 10 Sets = 20 Stück
Verpackung > siehe bitte Preisliste
INDEX = 10 sets = 20 pcs
package > check the pricelist

opal
G5999922





Das Profil kann verwendet werden, um eine Lichtzeichnung mit geraden Linien oder nach dem Bogen zu schaffen.

The profile can be used to create a light drawing using straight lines or arcs.



DEEP10 BC/UX

EINBAUPROFIL MIT DER MÖGLICHKEIT EINE HOMOGENE LICHTLINIE ZU ERREICHEN
A RECESSED PROFILE WHICH CAN GIVE A CONTINUOUS LINE EFFECT

- Anwendung hauptsächlich in Möbel oder in Rigipsplatten
 - eine homogene Lichtlinie (bei LED Streifen mit 120 leds/m und einer opalen Abdeckung)
 - die Wänden des LED Profils unter einem Winkel erfüllen die Rolle eines Reflektors
 - maximale Breite des LED Streifens 10 mm
-
- mainly used in furniture or plasterboard
 - continuous line of light (when using LED strip 120 P/m and opal cover)
 - angled profile sides are designed for better light reflection
 - maximum LED strip width: 10 mm

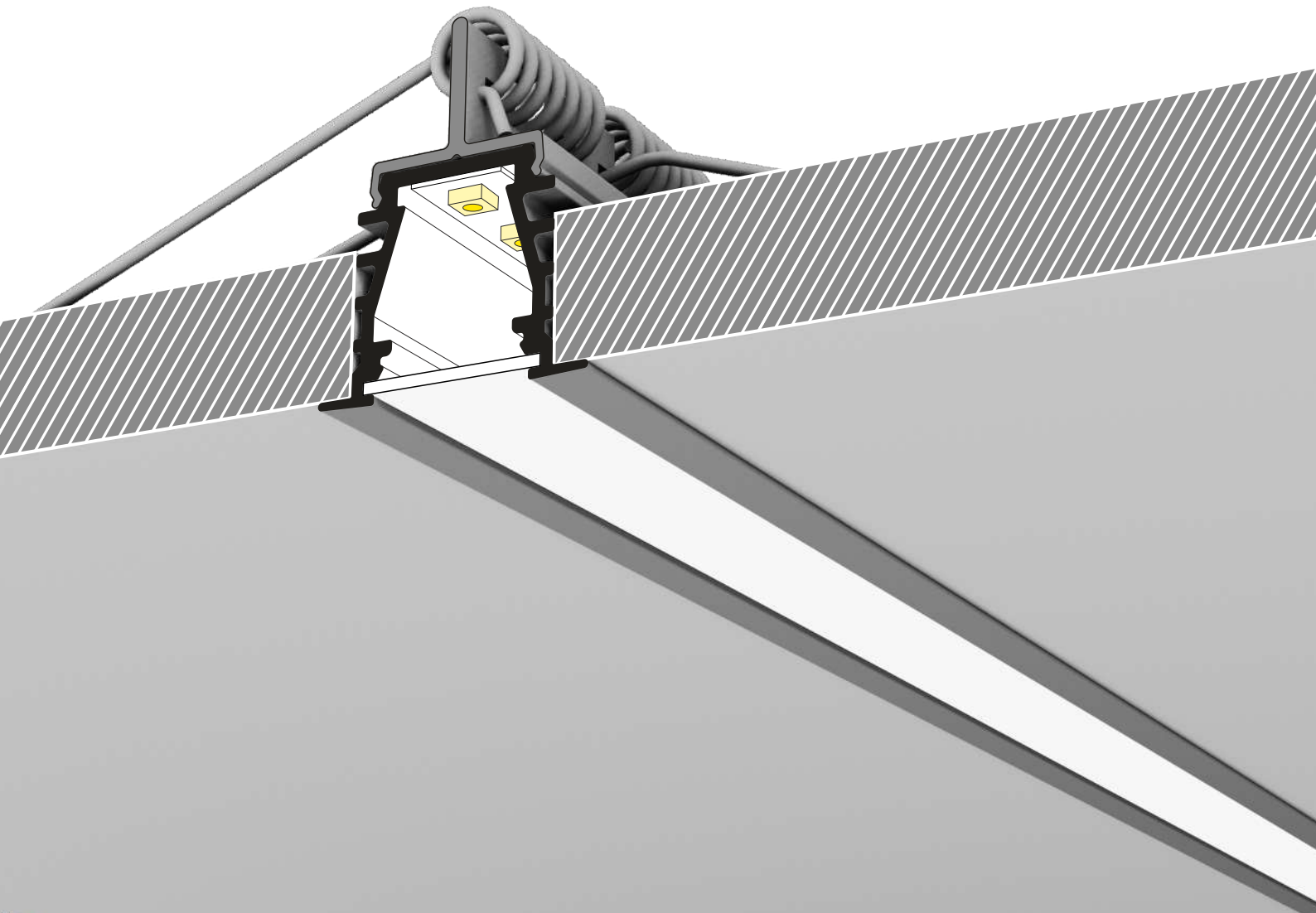

ÄHNLICHES IM ANGEBOT / SIMILAR IN THE OFFER



FLAT8
H/UX



BEGTIN12
J/S



GROOVE10
BC/UX



UNI12
BCD/U



GROOVE14
EF/TY



B Abdeckung **B** einziehbar
B slide cover

C Abdeckung **C** einclipsbar
C click cover

C Abdeckung **C** einclipsbar Linse
C lens cover

U¹ Halter **U** flexibel
U flexible mounting plate

U² Halter **U** flexibel cone
cone U flexible mounting plate

U³ Halter **U** flexibel rack
rack U flexible mounting plate

X¹ Halter **X**
X mounting plate

X² Halter **X** Feder
spring X mounting plate

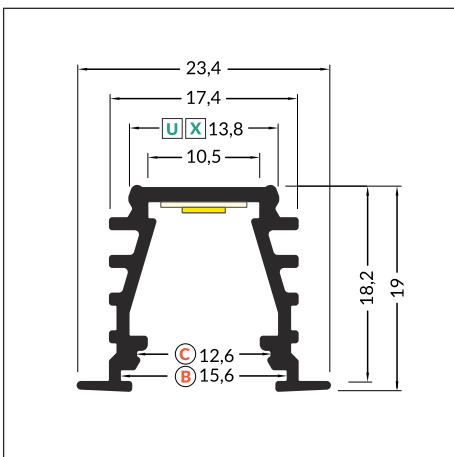
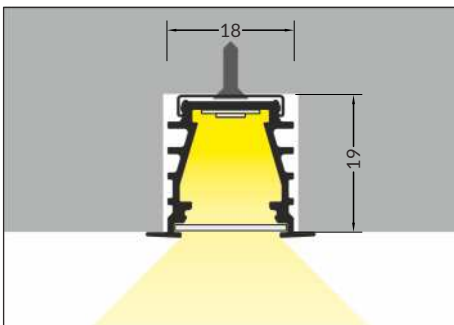
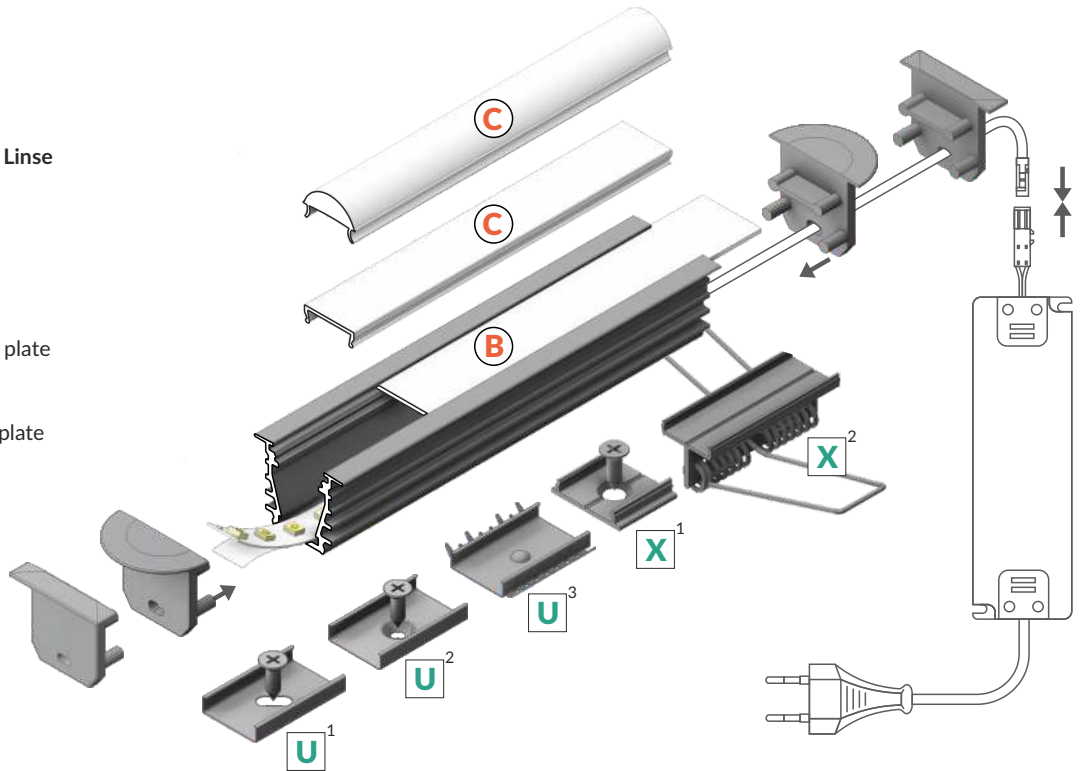

Artikelnummer = 1 Stück, Länge 2.000 mm
Verpackung > siehe bitte Preisliste
INDEX = 1 pc, length 2000 mm
package > check the pricelist

weiß lackiert
white painted
96030001



eloxiert
anodized
96030020



schwarz eloxiert
black anodized
96030021



Rohaluminium
raw aluminium
96030000



max 10 mm



Einbauprofile
recessed

Die zugänglichen Längen: 1000 mm, 2000 mm, 3000 mm, 4000 mm.
Die standardmäßige Toleranz der Länge von Profilen beträgt: +20 mm.
Mehr Informationen >> 1.08.

Available lengths: 1000 mm, 2000 mm, 3000 mm, 4000 mm.
The standard profile length tolerance is +20 mm.
More details >> 1.08.



ABDECKUNG / COVERS

Abdeckung B einziehbar
Farben: transparent, satiniert, opal
Material: PC, PP, PP

B slide cover
colours: transparent, frosted, opal
material: PC, PP, PP



Achtung! Die Abmessungen des Platzes für die Montage von LED Lichtquelle
Note! Dimensions of the space to install LED source

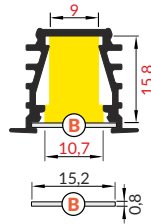

Abdeckung C einclipsbar
Farben: transparent, opal
Material: PMMA

C click cover
colours: transparent, opal
material: PMMA

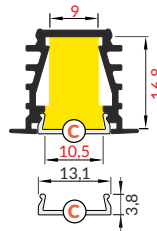

Abdeckung C einclipsbar Linse
Farben: transparent
Material: PC

C lens click cover
colour: transparent
material: PC

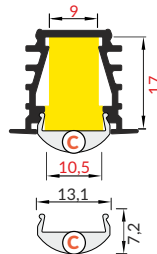

NEU

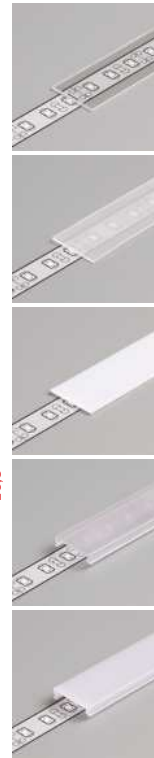

Länge 2.000 mm,
Verpackung > siehe bitte Preisliste
length 2000 mm
package > check the pricelist

B transparent
Artikelnummer = 10 Stück
index = 10 pcs
76250016

B satiniert / B frosted
Artikelnummer = 10 Stück
index = 10 pcs
76250039

B opal
Artikelnummer = 10 Stück
index = 10 pcs
76250038

C transparent
Artikelnummer = 1 Stück
index = 1 pc
76330000

C opal
Artikelnummer = 1 Stück
index = 1 pc
76330038

Rolle, Länge 20 m,
Verpackung > siehe bitte Preisliste
reel, length 20 m
package > check the pricelist

C opal
Artikelnummer = 1 Stück
index = 1 pc
76360038S

Länge 2.000 mm,
Verpackung > siehe bitte Preisliste
length 2000 mm
package > check the pricelist

C Linse / C lens
Artikelnummer = 1 Stück
index = 1 pc
76300000

Die Toleranz der Länge von Abdeckungen beträgt: +20 mm.
Mehr Informationen >> 1.08.

The standard cover length tolerance is +20 mm.
More details >> 1.08.

ENDKAPPEN / ENDINGS

Endkappe DEEP10 gen2 mit Öffnung
Farben: weiß, silbern, schwarz, grau
Material: ABS

DEEP10 ending gen2 with hole
colours: white, silver, black, grey
material: ABS

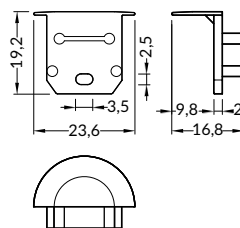

Endkappe DEEP10 gen2 SQ mit Öffnung
Farben: weiß, silbern, schwarz, grau
Material: ABS

DEEP10 ending gen2 SQ with hole
colours: white, silver, black, grey
material: ABS

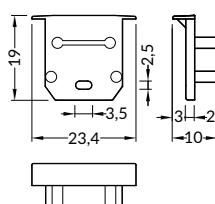

Artikelnummer = 10 Sets = 20 Stück
Verpackung > siehe bitte Preisliste
INDEX = 10 sets = 20 pcs
package > check the pricelist

weiß / white
96980001
silbern / silver
96980040
schwarz / black
96980002
grau / grey
96980022

weiß / white
96990001
silbern / silver
96990040
schwarz / black
96990002
grau / grey
96990022



VERBINDUNGSTÜCKE / CONNECTORS

Verbindungsstück X 180 Grad
Farben: Rohaluminium
Material: Aluminium

X connector 180 deg
colour: raw aluminium
material: aluminium

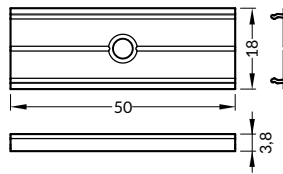

Artikelnummer = 1 Set
Verpackung > siehe bitte Preisliste
INDEX = 1 set
package > check the pricelist

Rohaluminium
raw aluminium
76350000

HALTER / MOUNTINGS

Halter U flexibel
Farben: inox
Material: rostfreier Stahl

U flexible mounting plate
colour: inox
material: stainless steel

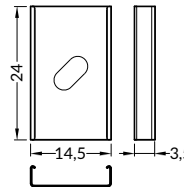
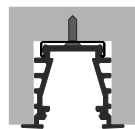

Artikelnummer = 10 Sets = 20 Stück
Verpackung > siehe bitte Preisliste
INDEX = 10 sets = 20 pcs
package > check the pricelist

inox
76380000

Halter U flexibel cone
Farben: inox
Material: rostfreier Stahl

cone U flexible mounting plate
colour: inox
material: stainless steel

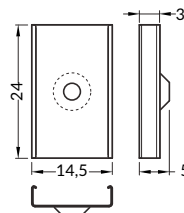

inox
76620000

Halter U flexibel rack
Farben: inox
Material: rostfreier Stahl

rack U flexible mounting plate
colour: inox
material: stainless steel

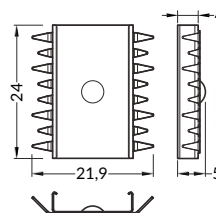

inox
76610019

Halter X
Farben: Rohaluminium
Material: Aluminium

X mounting plate
colour: raw aluminium
material: aluminium

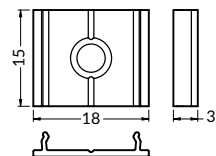

Rohaluminium
raw aluminium
76260000

Halter X Feder
Farben: Rohaluminium
Material: Aluminium

spring X mounting plate
colour: raw aluminium
material: aluminium

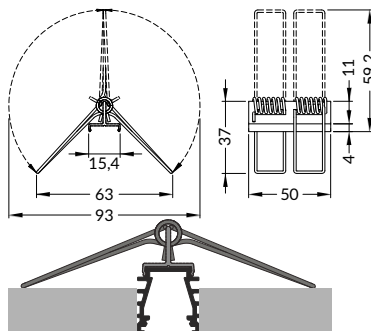

Artikelnummer = 1 Stück
Verpackung > siehe bitte Preisliste
INDEX = 1 pc
package > check the pricelist

Rohaluminium
raw aluminium
23130000



GROOVE10 BC/UX

EIN ALUMINIUMPROFIL FÜR EINBAU

RECESSED ALUMINIUM PROFILE

- hauptsächlich für Möbelbereich
- möglich ist auch die Anwendung an der Decke
- 6 Abdeckungen zur Wahl
- maximale Breite des LED Streifens 10 mm

- used mainly in furniture
- ceiling installation possible
- 6 types of covers
- maximum LED strip width: 10 mm



ÄHNLICHES IM ANGEBOT / SIMILAR IN THE OFFER



DEEP10
BC/UX



TRIO10
BC



BEGTIN12
J/S



UNI12
BCD/U



GROOVE14
EF/TY



- B** Abdeckung **B** einziehbar
B slide cover
- C** Abdeckung **C** einclipsbar
C click cover
- C** Abdeckung **C** einclipsbar Linse
C lens cover
- U**¹ Halter **U** flexibel
U flexible mounting plate
- U**² Halter **U** flexibel cone
cone U flexible mounting plate
- U**³ Halter **U** flexibel rack
rack U flexible mounting plate
- X**¹ Halter **X**
X mounting plate
- X**² Halter **X** Feder
spring X mounting plate

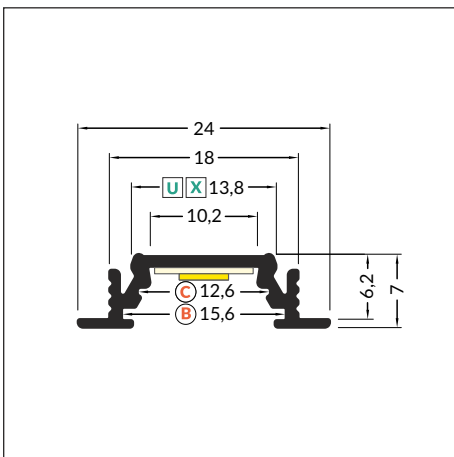
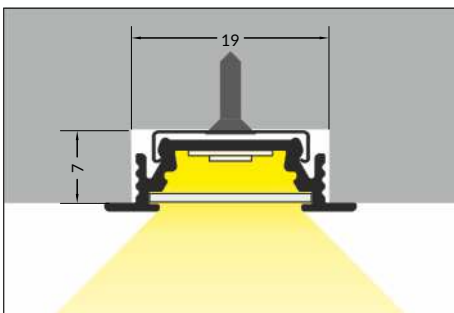
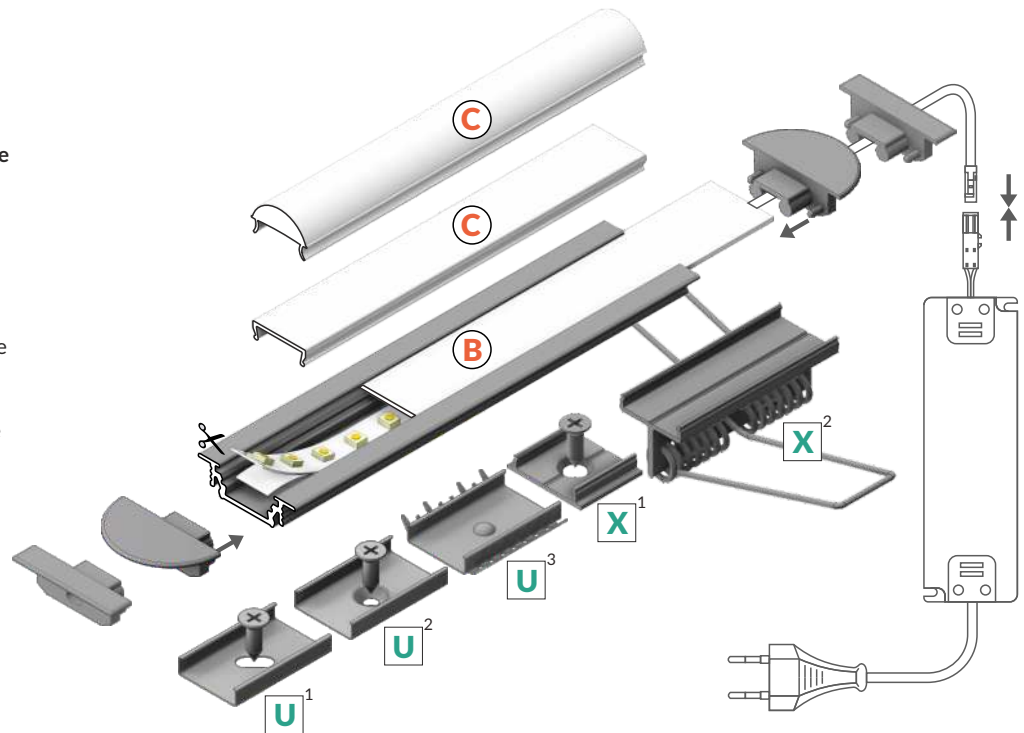

Artikelnummer = 1 Stück, Länge 2.000 mm
Verpackung > siehe bitte Preisliste
INDEX = 1 pc, length 2000 mm
package > check the pricelist

weiß lackiert
white painted
76210001



eloxiert
anodized
76210020



schwarz eloxiert
black anodized
76210021



Rohaluminium
raw aluminium
76210000



max 10 mm



Einbauprofile
recessed

Die zugänglichen Längen: 1000 mm, 2000 mm, 3000 mm, 4000 mm.
Die standardmäßige Toleranz der Länge von Profilen beträgt: +20 mm.
Mehr Informationen >> 1.08.

Available lengths: 1000 mm, 2000 mm, 3000 mm, 4000 mm.
The standard profile length tolerance is +20 mm.
More details >> 1.08.



ABDECKUNG / COVERS

Abdeckung B einschiebbar
Farben: transparent, satiniert, opal
Material: PC, PP, PP

B slide cover
colours: transparent, frosted, opal
material: PC, PP, PP

Abdeckung C einclipsbar
Farben: transparent, opal
Material: PMMA

C click cover
colours: transparent, opal
material: PMMA

Abdeckung C einclipsbar Linse
Farben: transparent
Material: PC

C click cover lens
colour: transparent
material: PC



Achtung! Die Abmessungen des Platzes für die Montage von LED Lichtquelle
Note! Dimensions of the space to install LED source

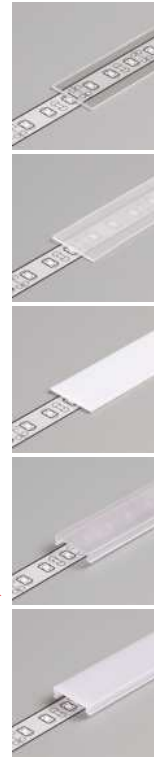
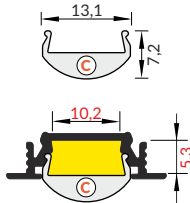
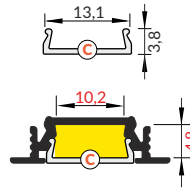
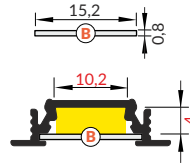

Länge 2.000 mm,
Verpackung > siehe bitte Preisliste
length 2000 mm
package > check the pricelist

B transparent
Artikelnummer = 10 Stück
index = 10 pcs

76250016

B satiniert / B frosted
Artikelnummer = 10 Stück
index = 10 pcs

76250039

B opal
Artikelnummer = 10 Stück
index = 10 pcs

76250038

C transparent
Artikelnummer = 1 Stück
index = 1 pc

76330000

C opal
Artikelnummer = 1 Stück
index = 1 pc

76330038

NEU

Rolle, Länge 20 m,
Verpackung > siehe bitte Preisliste
reel, length 20 m
package > check the pricelist

C opal
Artikelnummer = 1 Stück
index = 1 pc

76360038S

Länge 2.000 mm,
Verpackung > siehe bitte Preisliste
length 2000 mm
package > check the pricelist

C Linse / C lens
Artikelnummer = 1 Stück
index = 1 pc

76300000

Die Toleranz der Länge von Abdeckungen beträgt: +20 mm.
Mehr Informationen >> 1.08.

The standard cover length tolerance is +20 mm.
More details >> 1.08.

HALTER / MOUNTINGS

Halter U flexibel
Farben: inox
Material: rostfreier Stahl

U flexible mounting plate
colour: inox
material: stainless steel

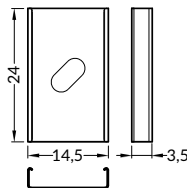
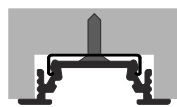

Artikelnummer = 10 Sets = 20 Stück
Verpackung > siehe bitte Preisliste
INDEX = 10 sets = 20 pcs
package > check the pricelist

inox
76380000

Halter U flexibel cone
Farben: inox
Material: rostfreier Stahl

cone **U** flexible mounting plate
colour: inox
material: stainless steel

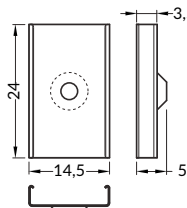
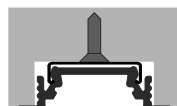

inox
76620000

Halter U flexibel rack
Farben: inox
Material: rostfreier Stahl

rack **U** flexible mounting plate
colour: inox
material: stainless steel

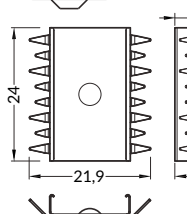

inox
76610019



HALTER / MOUNTINGS

Halter X
Farben: Rohaluminium
Material: Aluminium

X mounting plate
colours: raw aluminium
material: aluminium

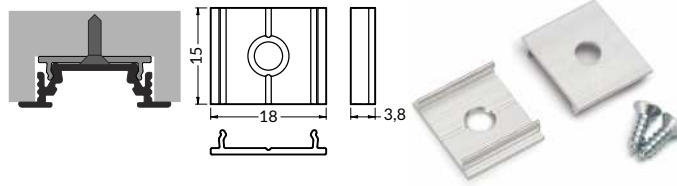

Artikelnummer = 10 Sets = 20 Stück
Verpackung > siehe bitte Preisliste
INDEX = 10 sets = 20 pcs
package > check the pricelist

Rohaluminium
raw aluminium
76260000

Halter X Feder
Farben: Rohaluminium
Material: Aluminium

spring X mounting plate
colours: raw aluminium
material: aluminium

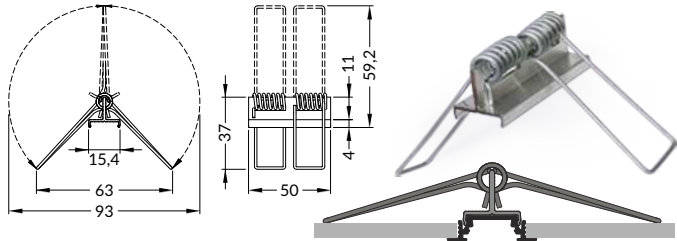

Artikelnummer = 1 Stück
Verpackung > siehe bitte Preisliste
INDEX = 1 pc
package > check the pricelist

Rohaluminium
raw aluminium
23130000

ENDKAPPEN / ENDINGS

Endkappe GROOVE10 gen2 mit Öffnung
Farben: weiß, silbern, schwarz, grau
Material: ABS

endings GROOVE10 gen2 with hole
colours: white, silver, black, grey
material: ABS

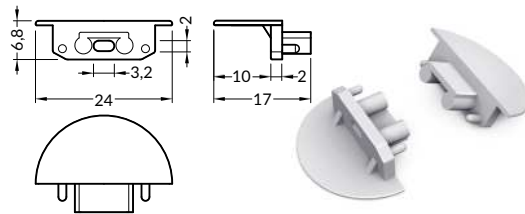

Artikelnummer = 10 Sets = 20 Stück
Verpackung > siehe bitte Preisliste
INDEX = 10 sets = 20 pcs
package > check the pricelist

weiß / white
76980001
silbern / silver
76980040
schwarz / black
76980002
grau / grey
76980022

Endkappe GROOVE10 gen2 SQ mit Öffnung
Farben: weiß, silbern, schwarz, grau
Material: ABS

endings GROOVE10 gen2 SQ with hole
colours: white, silver, black, grey
material: ABS

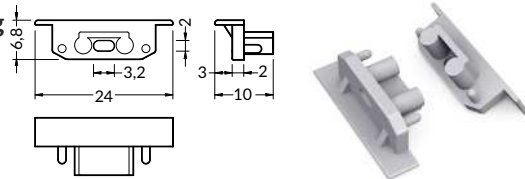

weiß / white
76990001
silbern / silver
76990040
schwarz / black
76990002
grau / grey
76990022

VERBINDUNGSSTÜCKE / CONNECTORS

Verbindungsstück X 180 Grad
Farben: Rohaluminium
Material: Aluminium

X connector 180 deg
colour: raw aluminium
material: aluminium

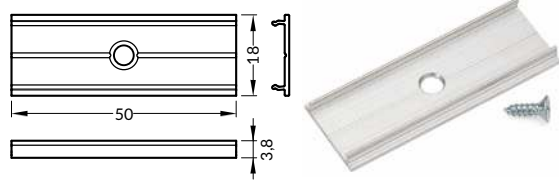

Artikelnummer = 1 Set
Verpackung > siehe bitte Preisliste
INDEX = 1 set
package > check the pricelist

Rohaluminium
raw aluminium
76350000

Verbinder 90 Grad für GROOVE10
Farben: weiß, eloxiert, schwarz
Material: Aluminium

GROOVE10 connector 90 deg
colours: white, anodized, black
material: aluminium

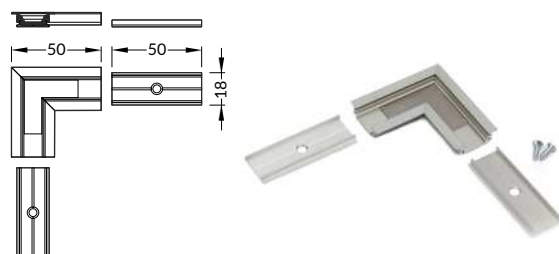

weiß lackiert
white painted
76530001
eloxiert
anodized
76530020
schwarz eloxiert
black anodized
76530021



EINE HOMOGENE LICHTLINIE IN EINEM KLEINEN EINBAUPROFIL

CONTINUOUS LIGHT LINE IN SMALL RECESSED PROFILE

- für die Anwendung in einer Rigipsplatte - ohne in die Konstruktion der Platte einzugreifen
- auch für die Anwendung in Möbel
- eine homogene Lichtlinie (bei LED Streifen mit 120 leds/m und einer opalen Abdeckung)
- Sockel mit Slick Funktion
- kleine Maße
- maximale Breite des LED Streifens 10 mm

- suitable for use in plasterboards - does not affect the structure of the board
- used also in furniture
- continuous line of light (when using LED strip 120 P/m and opal cover)
- SLICK socket
- miniature dimensions
- maximum width of LED strip: 10 mm



ÄHNLICHES IM ANGEBOT / SIMILAR IN THE OFFER



DEEP10
BC/UX



SMART10
AC2/Z



GROOVE10
BC/UX



BEGTIN12
J/S



UNI12
BCD/U



GROOVE14
EF/TY



A Abdeckung **A** einschiebbar
A slide cover

C2 Abdeckung **C2** einclipsbar
C2 click cover

Z¹ Halter **Z** flexibel
Z flexible mounting plate

Z² Halter **Z** flexibel cone
cone Z flexible mounting plate

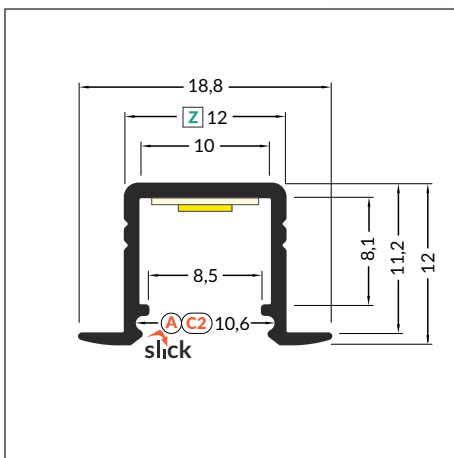
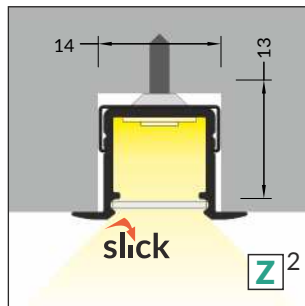
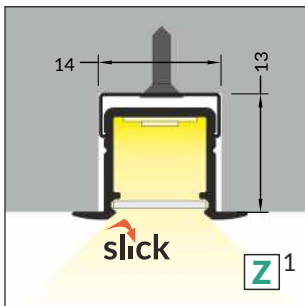
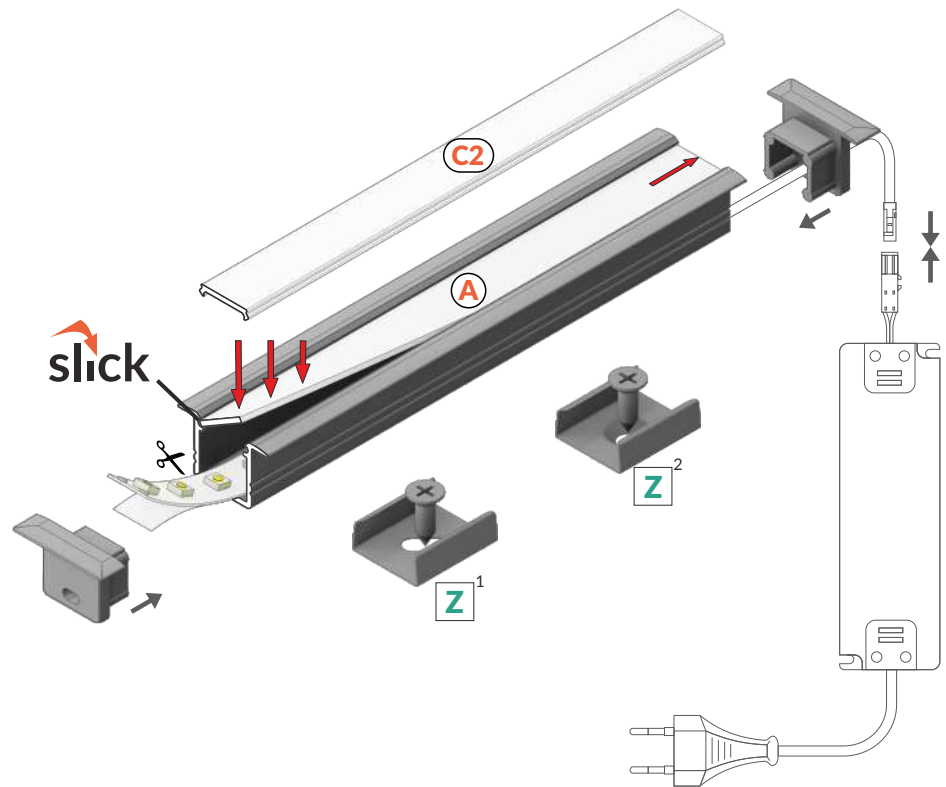

 max 10 mm

 Einbauprofile
recessed



Artikelnummer = 1 Stück, Länge 2.000 mm
Verpackung > siehe bitte Preisliste
INDEX = 1 pc, length 2000 mm
package > check the pricelist

weiß lackiert
white painted
E3020001

eloxiert
anodized
E3020020

schwarz eloxiert
black anodized
E3020021

Rohaluminium
raw aluminium
E3020000

Die zugänglichen Längen: 1000 mm, 2000 mm, 3000 mm, 4000 mm.
Die standardmäßige Toleranz der Länge von Profilen beträgt: +20 mm.
Mehr Informationen >> 1.08.

Available lengths: 1000 mm, 2000 mm, 3000 mm, 4000 mm.
The standard profile length tolerance is +20 mm.
More details >> 1.08.



ABDECKUNG / COVERS

Abdeckung A einziehbar
Farben: transparent, satiniert, opal
Material: PC, PP, PP

A slide cover
colours: transparent, frosted, opal
material: PC, PP, PP



Achtung! Die Abmessungen des Platzes für die Montage von LED Lichtquelle
Note! Dimensions of the space to install LED source

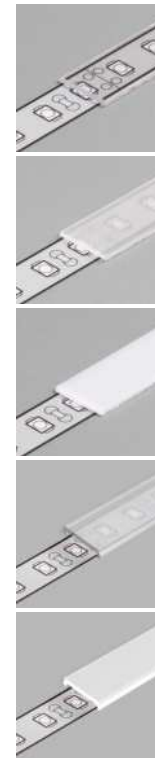
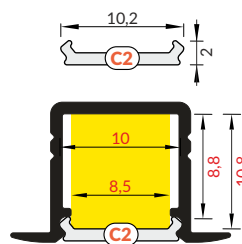
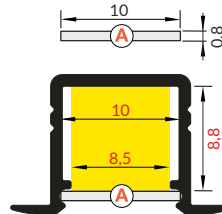

Länge 2.000 mm,
Verpackung > siehe bitte Preisliste
length 2000 mm
package > check the pricelist

A transparent
Artikelnummer = 10 Stück
index = 10 pcs

89070016

A satiniert / A frosted
Artikelnummer = 10 Stück
index = 10 pcs

89070039

A opal
Artikelnummer = 10 Stück
index = 10 pcs

89070038

C2 transparent
Artikelnummer = 1 Stück
index = 1 pc

89000216

C2 opal
Artikelnummer = 1 Stück
index = 1 pc

89000238

Die Toleranz der Länge von Abdeckungen beträgt: +20 mm.
Mehr Informationen >> 1.08.
The standard cover length tolerance is +20 mm.
More details >> 1.08.

Abdeckung C2 einclipsbar
Farben: transparent, opal
Material: PMMA

NEU

C2 click cover
colours: transparent, opal
material: PMMA

ENDKAPPEN / ENDINGS

Endkappe SMART-IN10 mit Öffnung
Farben: weiß, silbern, schwarz, grau
Material: ABS

SMART-IN10 ending with hole
colours: white, silver, black, grey
material: ABS

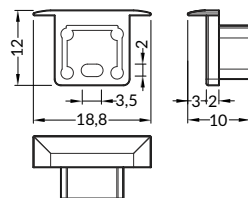

Artikelnummer = 10 Sets = 20 Stück
Verpackung > siehe bitte Preisliste
INDEX = 10 sets = 20 pcs
package > check the pricelist

weiß / white
E3990001

silbern / silver
E3990040

schwarz / black
E3990002

grau / grey
E3990022

HALTER / MOUNTINGS

Halter Z flexibel
Farben: weiß, inox, schwarz
Material: rostfreier Stahl

Z flexible mounting plate
colours: white, inox, black
material: stainless steel

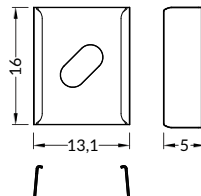
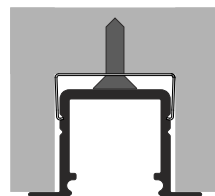

Artikelnummer = 10 Sets = 20 Stück
Verpackung > siehe bitte Preisliste
INDEX = 10 sets = 20 pcs
package > check the pricelist

weiß / white
89270001

inox
89270019

schwarz / black
89270002

Halter Z flexibel cone
Farben: weiß, inox, schwarz
Material: rostfreier Stahl

cone **Z** flexible mounting plate
colours: white, inox, black
material: stainless steel

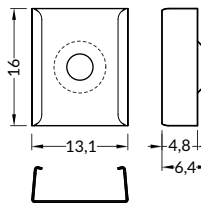
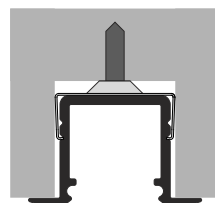

weiß / white
89980001

inox
89980019

schwarz / black
89980002



EIN KLEINES ALUMINIUMPROFIL FÜR EINBAU

SMALL RECESSED ALUMINIUM PROFILE

- ein leichtes Budget-Profil
- hauptsächlich für die Anwendung in Möbel
- Sockel mit Slick Funktion
- maximale Breite des LED Streifens 12 mm

- light weight, budget profile
- used mainly in furniture
- Slick socket
- maximum LED strip width: 12 mm



ÄHNLICHES IM ANGEBOT / SIMILAR IN THE OFFER



DEEP10
BC/UX



GROOVE10
BC/UX



SMART-IN10
AC2/Z



BEGTIN12
J/S



J Abdeckung **J** einziehbar
J slide cover

S¹ Halter **S** flexibel
S flexible mounting plate

S² Halter **S** flexibel cone
 cone **S** flexible mounting plate

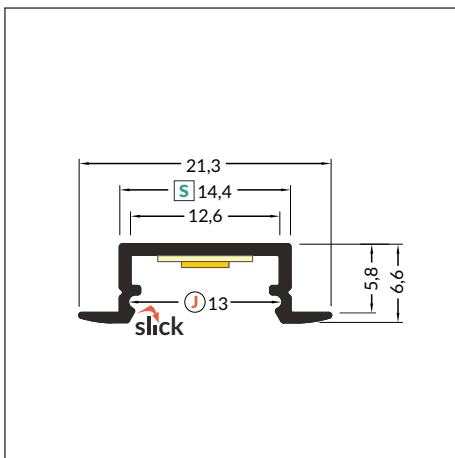
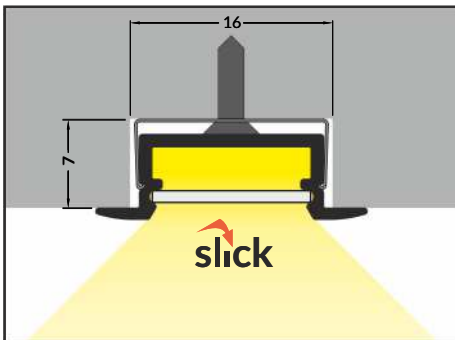
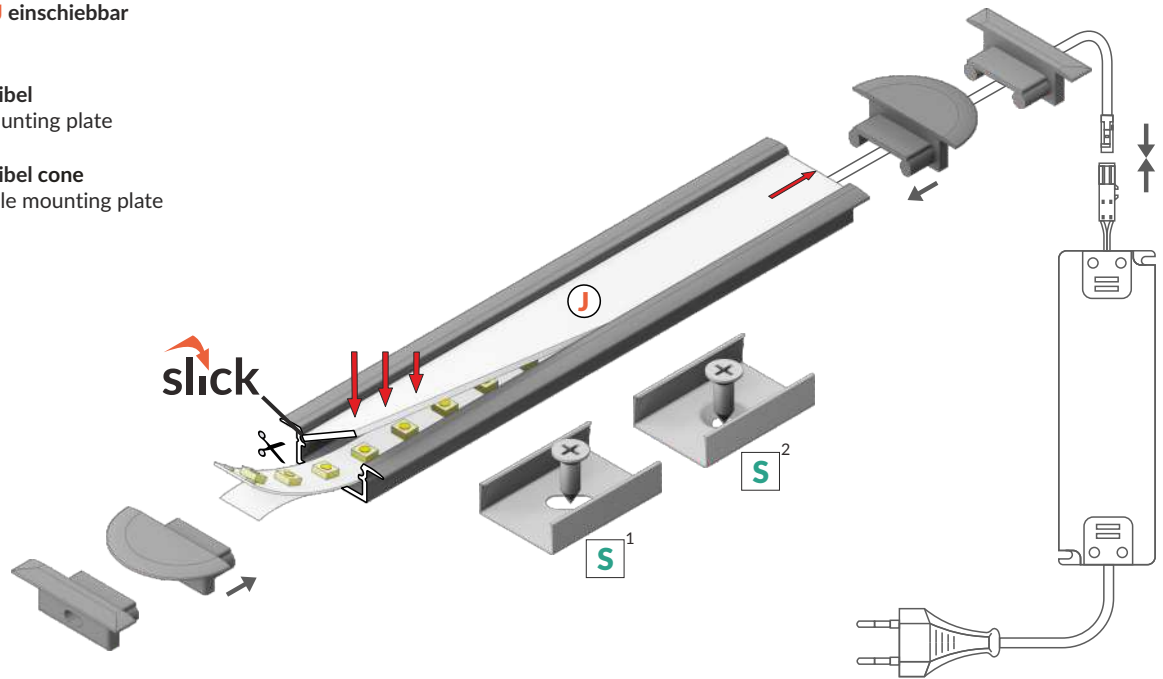

Artikelnummer = 1 Stück, Länge 2.000 mm
 Verpackung > siehe bitte Preisliste
 INDEX = 1 pc, length 2000 mm
 package > check the pricelist

weiß lackiert
 white painted
C8020001



eloxiert
 anodized
C8020020



schwarz eloxiert
 black anodized
C8020021



Rohaluminium
 raw aluminium
C8020000

 max 12 mm

 Einbauprofile
 recessed

Die zugänglichen Längen: 1000 mm, 2000 mm, 3000 mm, 4000 mm.
 Die standardmäßige Toleranz der Länge von Profilen beträgt: +20 mm.
 Mehr Informationen >> 1.08.

Available lengths: 1000 mm, 2000 mm, 3000 mm, 4000 mm.
 The standard profile length tolerance is +20 mm.
 More details >> 1.08.



ABDECKUNG / COVERS

Abdeckung **J** einziehbar
Farben: transparent, satiniert, opal
Material: PC, PP, PP

J slide cover
colours: transparent, frosted, opal
material: PC, PP, PP



Achtung! Die Abmessungen des Platzes für die Montage von LED Lichtquelle
Note! Dimensions of the space to install LED source

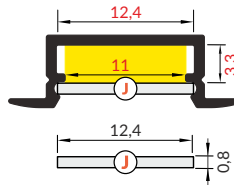

Länge 2.000 mm,
Verpackung > siehe bitte Preisliste
length 2000 mm
package > check the pricelist

B transparent
Artikelnummer = 10 Stück
index = 10 pcs

70330016

B satiniert / B frosted
Artikelnummer = 10 Stück
index = 10 pcs

70330039

B opal
Artikelnummer = 10 Stück
index = 10 pcs

70330038

Die Toleranz der Länge von Abdeckungen beträgt: +20 mm.
Mehr Informationen >> 1.08.

The standard cover length tolerance is +20 mm.
More details >> 1.08.

ENDKAPPEN / ENDINGS

Endkappe **BEGTIN12 gen2 mit Öffnung**
Farben: weiß, silbern, schwarz, grau
Material: ABS

BEGTIN12 ending gen2 with hole
colours: white, silver, black, grey
material: ABS

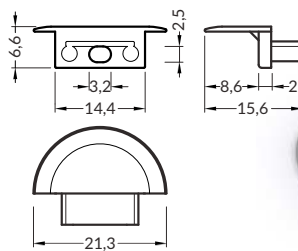

Endkappe **BEGTIN12 gen2 SQ mit Öffnung**
Farben: weiß, silbern, schwarz, grau
Material: ABS

BEGTIN12 ending gen2 SQ with hole
colours: white, silver, black, grey
material: ABS

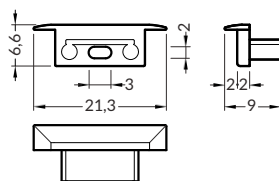

Artikelnummer = 10 Sets = 20 Stück
Verpackung > siehe bitte Preisliste
INDEX = 10 sets = 20 pcs
package > check the pricelist

weiß / white
C8980001

silbern / silver
C8980040

schwarz / black
C8980002

grau / grey
C8980022

weiß / white
C8970001

silbern / silver
C8970040

schwarz / black
C8970002

grau / grey
C8970022

HALTER / MOUNTINGS

Halter **S flexibel**
Farben: weiß, inox, schwarz
Material: rostfreier Stahl

S flexible mounting plate
colours: white, inox, black
material: stainless steel

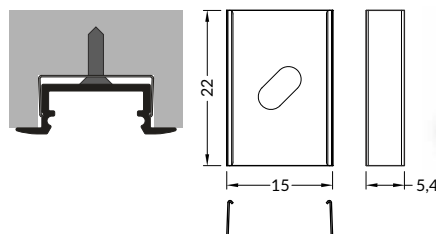

Artikelnummer = 10 Sets = 20 Stück
Verpackung > siehe bitte Preisliste
INDEX = 10 sets = 20 pcs
package > check the pricelist

weiß / white
C7980001

inox
C7980019

schwarz / black
C7980002

Halter **S flexibel cone**
Farben: weiß, inox, schwarz
Material: rostfreier Stahl

cone **S** flexible mounting plate
colours: white, inox, black
material: stainless steel

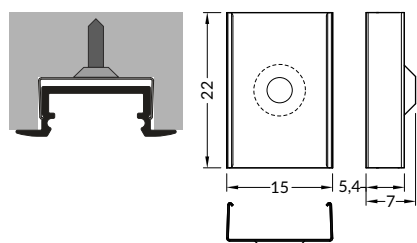

weiß / white
C7950001

inox
C7950019

schwarz / black
C7950002



FLOOR K

EINBAUPROFILE FÜR FUSSBÖDEN

RECESSED FLOOR PROFILES

- eine hohe Beständigkeit gegen Abwischbarkeit, eine feste Abdeckung
- das Erreichen von Wasserbeständigkeit ist möglich
- bei einer erhöhten Feuchtigkeit soll man ein wasserdichtes LED Streifen verwenden
- high abrasion resistance, resistant cover
- possibility of waterproof
- with high humidity, please use waterproof tape



ÄHNLICHES IM ANGEBOT / SIMILAR IN THE OFFER



STEP10
C



DEEP10
BC/UX



UNI12
BCD/U



UNI-TILE12
90 deg C



UNI-TILE12
180 deg C

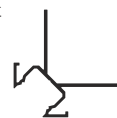

UNI-TILE12
270 deg C



FLOOR8 K

NEU

Optimale Höhe
für den Einbau
in Standardfliesen
oder Fussbodenpanelen > 3.31

Optimal height
for installation
in standard tiles
or floor panels > 3.31



max 8 mm

240
P/m

für homogene Lichtlinie
for continuous
line of light

FLOOR12 K/U

Die ideale Lösung
zur Verwendung
in dickeren
Fussbodenmaterialien > 3.33

The perfect solution
for application
in thicker floor
materials > 3.33



max 12 mm

120
P/m

für homogene Lichtlinie
for continuous
line of light

K Abdeckung K einclipsbar
K click cover

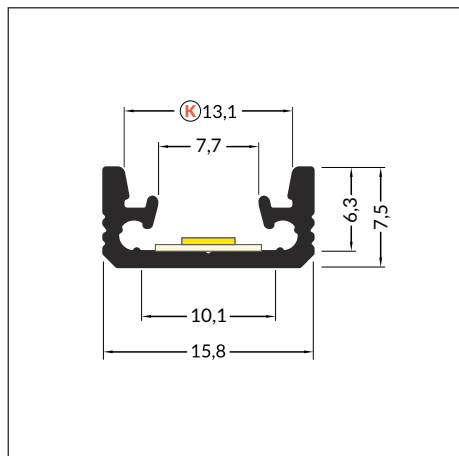
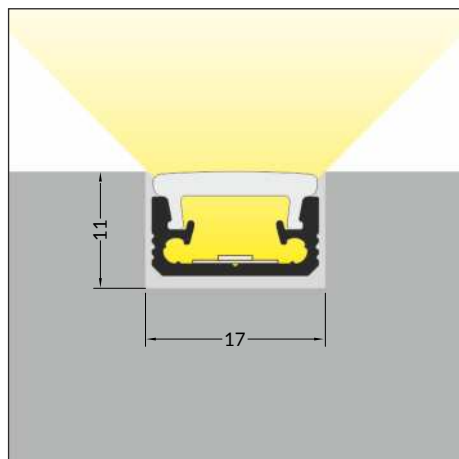
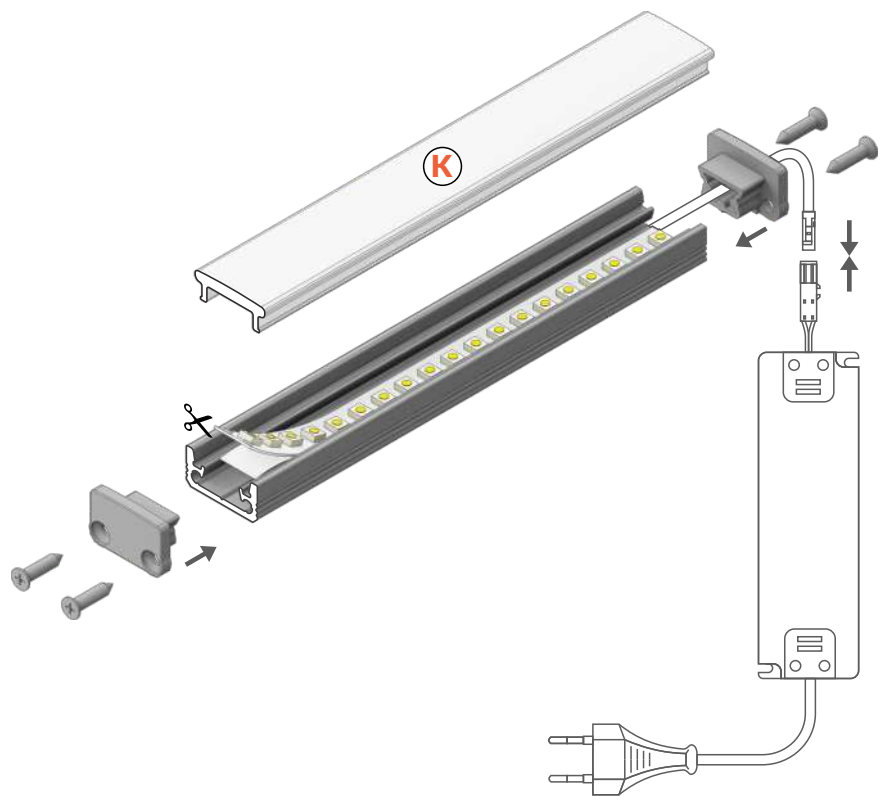

Artikelnummer = 1 Stück, Länge 2.000 mm
Verpackung > siehe bitte Preisliste
INDEX = 1 pc, length 2000 mm
package > check the pricelist



eloxiert
anodized
G6000220

Die zugänglichen Längen: 1000 mm, 2000 mm, 3000 mm, 4000 mm.
Die standardmäßige Toleranz der Länge von Profilen beträgt: +20 mm.
Mehr Informationen >> 1.08.

Available lengths: 1000 mm, 2000 mm, 3000 mm, 4000 mm.
The standard profile length tolerance is +20 mm.
More details >> 1.08.



max 8 mm



Einbauprofile
recessed



IK08 (5 J)



↓ 5 J





ABDECKUNG / COVERS

Abdeckung **K** einclipsbar

Farben: opal
Material: PC

K click cover
colour: opal
material: PC



Achtung! Die Abmessungen des Platzes für die Montage von LED Lichtquelle
Note! Dimensions of the space to install LED source

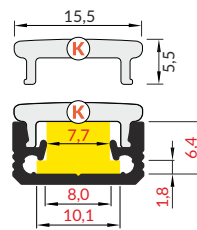

Länge 2.000 mm,
Verpackung > siehe bitte Preisliste
length 2000 mm
package > check the pricelist

K opal
Artikelnummer = 1 Stück
index = 1 pc

B1040038

Die Toleranz der Länge von Abdeckungen beträgt: +20 mm.
Mehr Informationen >> 1.08.

The standard cover length tolerance is +20 mm.
More details >> 1.08.

ENDKAPPEN / ENDINGS

Endkappe FLOOR8

Farben: silbern, grau
Material: ABS

FLOOR8 ending
colours: silver, grey
material: ABS

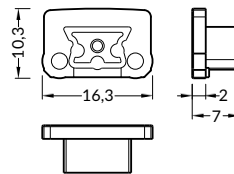

Artikelnummer = 10 Sets = 20 Stück
Verpackung > siehe bitte Preisliste
INDEX = 10 sets = 20 pcs
package > check the pricelist

silbern / silver
G6999940

grau / grey
G6999922

DICHTUNGSSET / SEALING

Dichtungsringe für Endkappe FLOOR8

2x Silikondichtung
4x Dichtungsring

sealings for FLOOR8 endings
2x silicone sealings
4x rubber o-ring



bei erhöhter Feuchtigkeit
empfehlen wir ein Abdichtungsset
und ein wasserdichtes
LED Streifen zu verwenden
In high humidity conditions
use waterproof tape and silicone seal



Artikelnummer = 1 Set
Verpackung > siehe bitte Preisliste
INDEX = 1 set
package > check the pricelist

G69998005



FLOOR12 K/U



- K** Abdeckung K einclipsbar
K click cover
- U¹** Halter U flexibel
U flexible mounting plate
- U²** Halter U flexibel cone
cone U flexible mounting plate

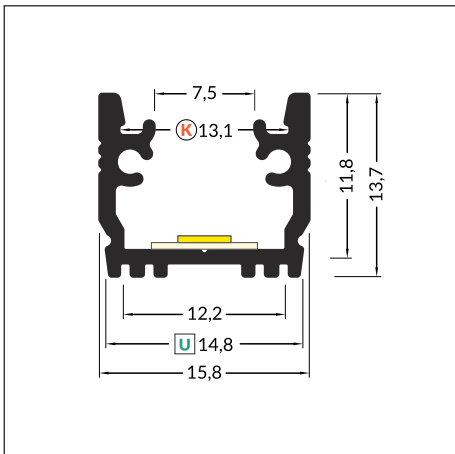
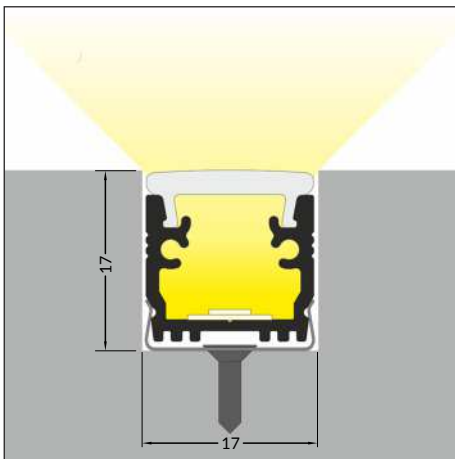
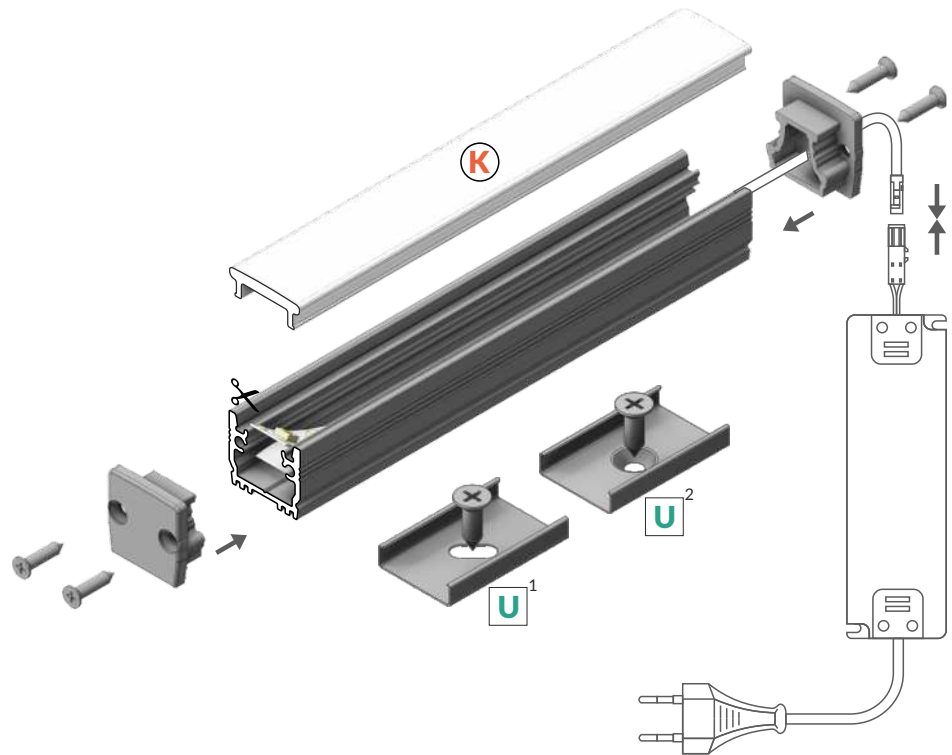

Artikelnummer = 1 Stück, Länge 2.000 mm
Verpackung > siehe bitte Preisliste
INDEX = 1 pc, length 2000 mm
package > check the pricelist



eloxiert
anodized
B1020020

Die zugänglichen Längen: 1000 mm, 2000 mm, 3000 mm, 4000 mm.
Die standardmäßige Toleranz der Länge von Profilen beträgt: +20 mm.
Mehr Informationen >> 1.08.

Available lengths: 1000 mm, 2000 mm, 3000 mm, 4000 mm.
The standard profile length tolerance is +20 mm.
More details >> 1.08.



max 12 mm



Einbauprofile
recessed



IK08 (5 J)



↓ 5 J

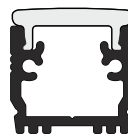



ABDECKUNG / COVERS

Abdeckung **K** einclipbar
Farben: opal
Material: PC

K click cover
colour: opal
material: PC



Achtung! Die Abmessungen des Platzes für die Montage von LED Lichtquelle
Note! Dimensions of the space to install LED source

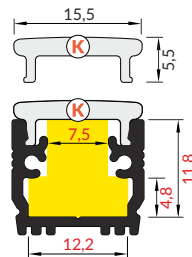

Länge 2.000 mm,
Verpackung > siehe bitte Preisliste
length 2000 mm
package > check the pricelist

K opal
Artikelnummer = 1 Stück
index = 1 pc
B1040038

Die Toleranz der Länge von Abdeckungen beträgt: +20 mm.
Mehr Informationen >> 1.08.
The standard cover length tolerance is +20 mm.
More details >> 1.08.

ENDKAPPEN / ENDINGS

Endkappe FLOOR12
Farben: silbern, grau
Material: ABS

FLOOR12 ending
colours: silver, grey
material: ABS

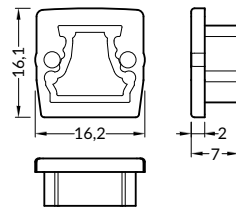

Artikelnummer = 10 Sets = 20 Stück
Verpackung > siehe bitte Preisliste
INDEX = 10 sets = 20 pcs
package > check the pricelist

silbern / silver
B1940040

grau / grey
B1940022

Endkappe FLOOR12 mit Öffnung
Farben: silbern, grau
Material: ABS

FLOOR12 ending with hole
colours: silver, grey
material: ABS

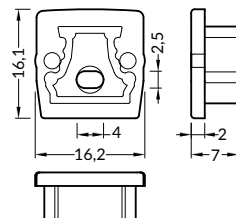

silbern / silver
B1960040

grau / grey
B1960022

HALTER / MOUNTINGS

Halter **U** flexibel
Farben: inox
Material: rostfreier Stahl

U flexible mounting plate
colour: inox
material: stainless steel

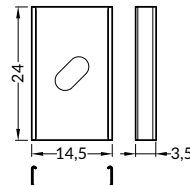
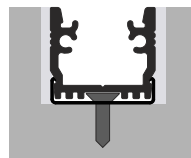

Artikelnummer = 10 Sets = 20 Stück
Verpackung > siehe bitte Preisliste
INDEX = 10 sets = 20 pcs
package > check the pricelist

inox
76380000

Halter **U** flexibel cone
Farben: inox
Material: rostfreier Stahl

cone **U** flexible mounting plate
colour: inox
material: stainless steel

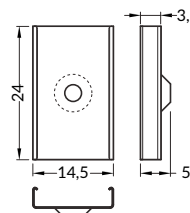
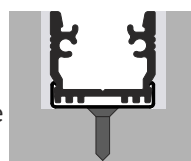

inox
76620000

DICHTUNGSSET / SEALING

Dichtungsringe für Endkappe FLOOR12
2x Silikondichtung
4x Dichtungsring

sealings for FLOOR12 endings
2x silicone sealings
4x rubber o-ring



bei erhöhter Feuchtigkeit empfehlen wir ein Abdichtungsset und ein wasserdichtes LED Streifen zu verwenden
In high humidity conditions use waterproof tape and silicone seal



Artikelnummer = 1 Set
Verpackung > siehe bitte Preisliste
INDEX = 1 set
package > check the pricelist

B1830000

GROOVE14 EF/TY

EIN GRUNDLEGENDES EINBAUALUMINIUMPROFIL

BASIC ALUMINIUM RECESSED PROFILE

- hauptsächlich für Möbelbereich
- maximale Breite des LED Streifens 14 mm

- used mainly in furniture
- maximum LED strip width: 14 mm

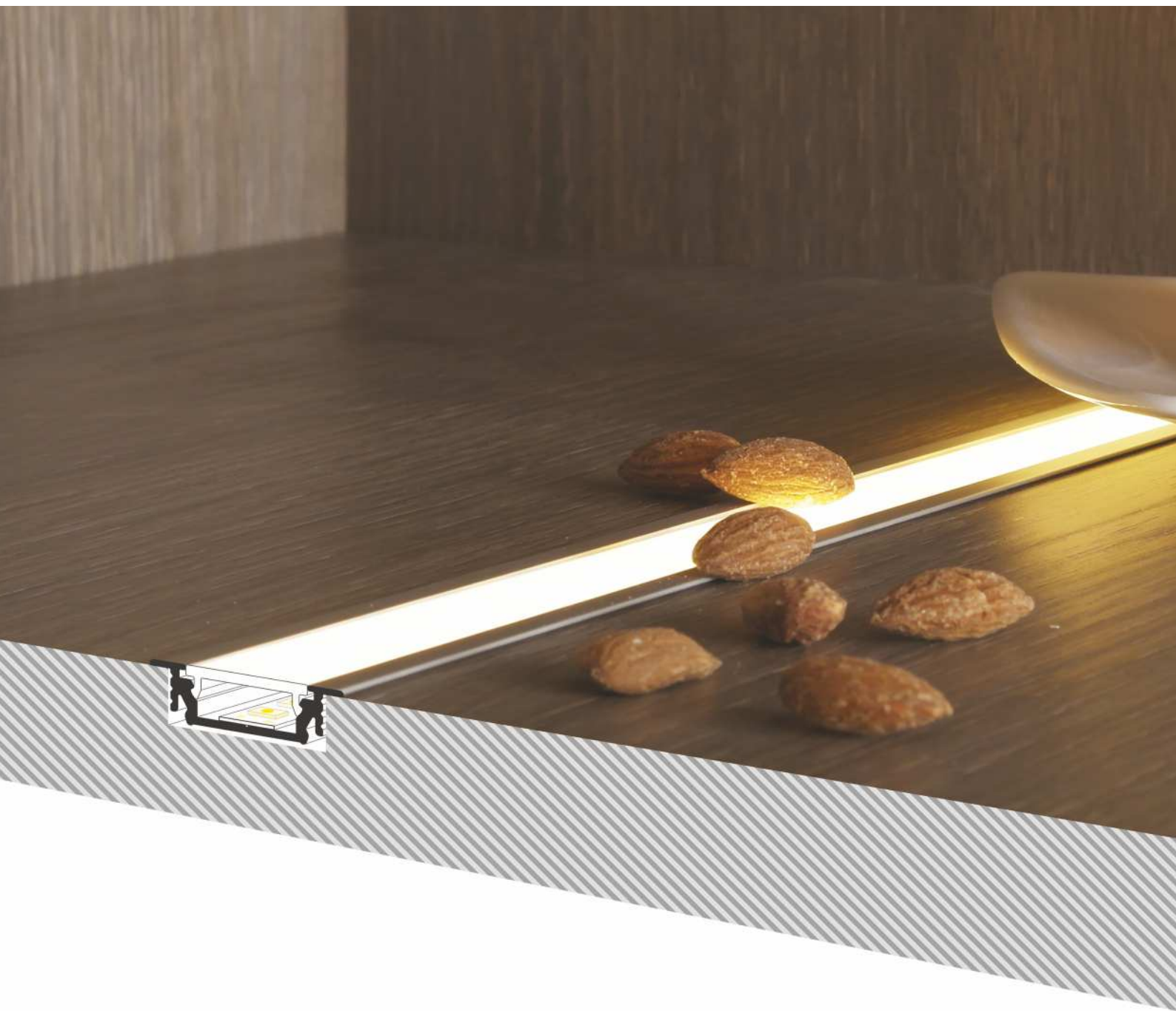

ÄHNLICHES IM ANGEBOT / SIMILAR IN THE OFFER





- E** Abdeckung E einschiebbar
E slide cover
- F** Abdeckung F einclipsbar
F click cover
- E7** Abdeckung E7 einclipsbar
E7 click cover
- Y¹** Halter Y flexibel
Y flexible mounting plate
- Y²** Halter Y flexibel cone
cone Y flexible mounting plate
- T** Halter T
T mounting plate

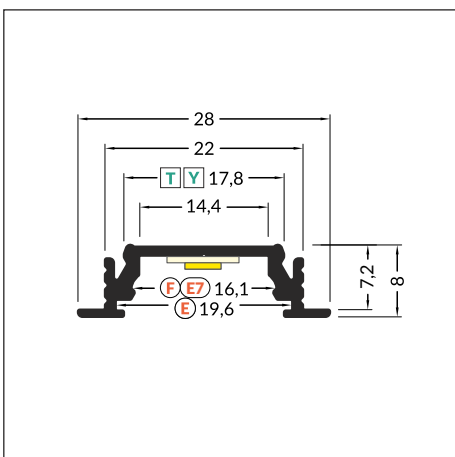
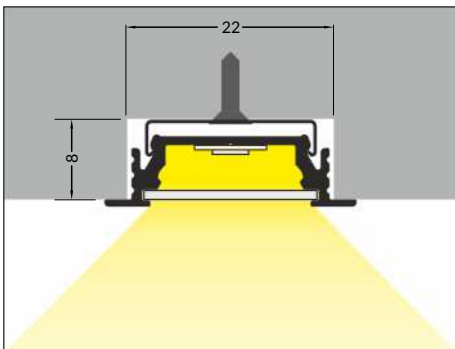
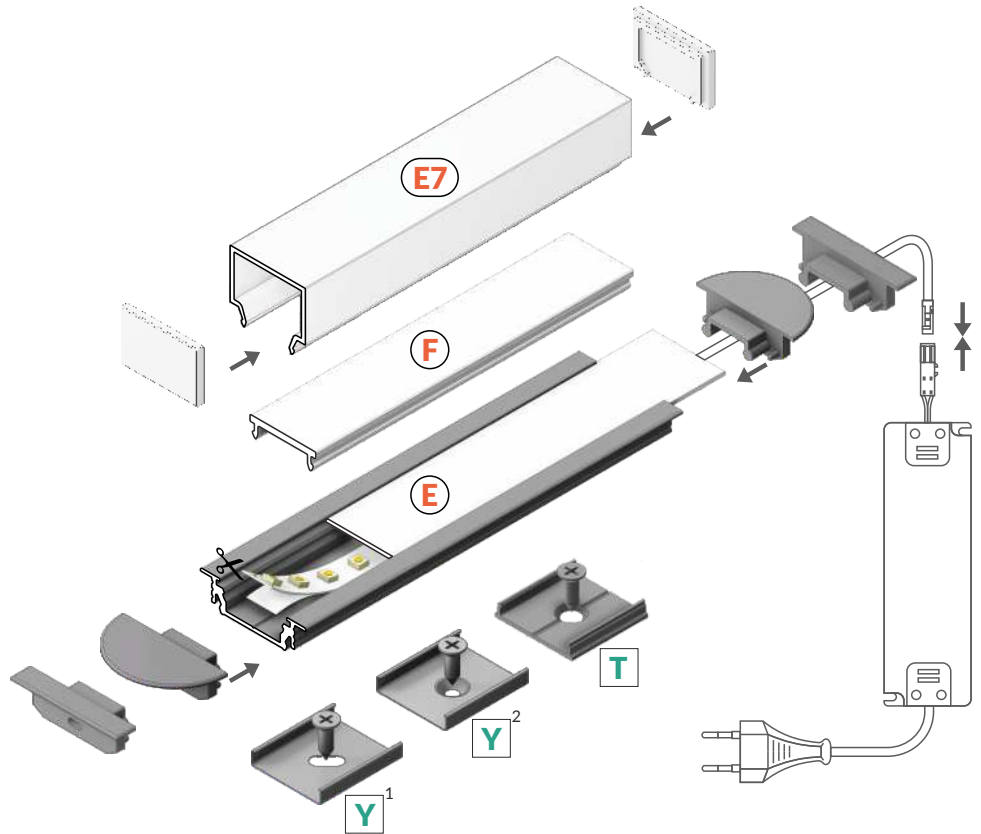

max 14 mm



Einbauprofile
recessed

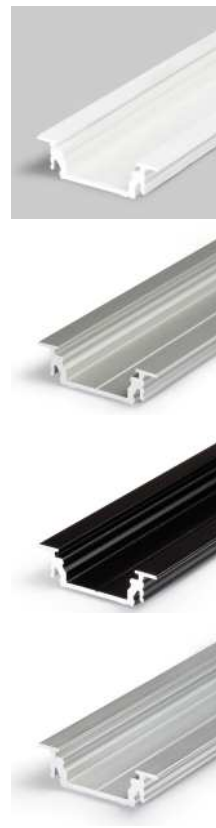

Artikelnummer = 1 Stück, Länge 2.000 mm
Verpackung > siehe bitte Preisliste
INDEX = 1 pc, length 2000 mm
package > check the pricelist

weiß lackiert
white painted
A3020001

eloxiert
anodized
A3020020

schwarz eloxiert
black anodized
A3020021

Rohaluminium
raw aluminium
A3020000

Die zugänglichen Längen: 1000 mm, 2000 mm, 3000 mm, 4000 mm.
Die standardmäßige Toleranz der Länge von Profilen beträgt: +20 mm.
Mehr Informationen >> 1.08.

Available lengths: 1000 mm, 2000 mm, 3000 mm, 4000 mm.
The standard profile length tolerance is +20 mm.
More details >> 1.08.



ABDECKUNG / COVERS

Abdeckung E einziehbar
Farben: transparent, satiniert, opal
Material: PC, PP, PP

E slide cover
colours: transparent, frosted, opal
material: PC, PP, PP



Achtung! Die Abmessungen des Platzes für die Montage von LED Lichtquelle
Note! Dimensions of the space to install LED source

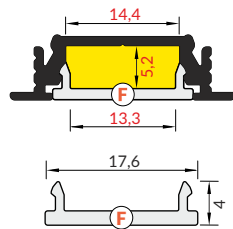
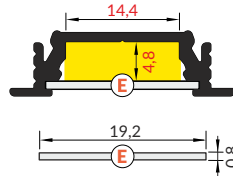

Abdeckung F einclipsbar
Farben: transparent, opal
Material: PMMA

F click cover
colours: transparent, opal
material: PMMA

Abdeckung E7 einclipsbar
Farben: opal
Material: PMMA

E7 click cover
colour: opal
material: PMMA

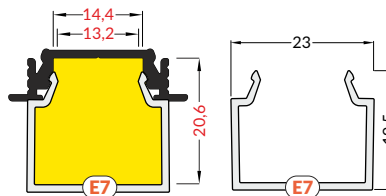

NEU

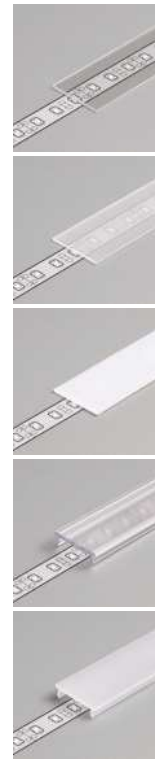

Länge 2.000 mm,
Verpackung > siehe bitte Preisliste
length 2000 mm
package > check the pricelist

E transparent
Artikelnummer = 10 Stück
index = 10 pcs
A2040016

E satiniert / **E** frosted
Artikelnummer = 10 Stück
index = 10 pcs
A2040039

E opal
Artikelnummer = 10 Stück
index = 10 pcs
A2040038

F transparent
Artikelnummer = 1 Stück
index = 1 pc
A2060016

F opal
Artikelnummer = 1 Stück
index = 1 pc
A2060038

Rolle, Länge 20 m,
Verpackung > siehe bitte Preisliste
reel, length 20 m
package > check the pricelist

F opal
Artikelnummer = 1 Stück
index = 1 pc
A22100385

Länge 2.000 mm,
Verpackung > siehe bitte Preisliste
length 2000 mm
package > check the pricelist

E7 opal
Artikelnummer = 1 Stück
index = 1 pc
C1080038

Die Toleranz der Länge von Abdeckungen beträgt: +20 mm.
Mehr Informationen >> 1.08.
The standard cover length tolerance is +20 mm.
More details >> 1.08.

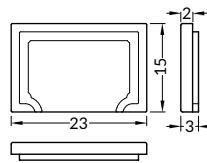

Artikelnummer = 1 Set = 2 Stück
Verpackung > siehe bitte Preisliste
INDEX = 1 set = 2 pcs
package > check the pricelist

Endkappe **E7** opal
E7 opal ending
C1840038

HALTER / MOUNTINGS

Halter Y flexibel
Farben: inox
Material: rostfreier Stahl
Y flexible mounting plate
colour: inox
material: stainless steel

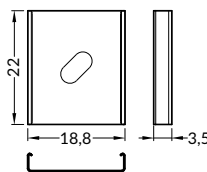
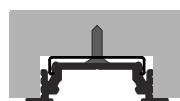

Artikelnummer = 10 Sets = 20 Stück
Verpackung > siehe bitte Preisliste
INDEX = 10 sets = 20 pcs
package > check the pricelist

inox
A2090019

Halter Y flexibel cone
Farben: inox
Material: rostfreier Stahl
cone **Y** flexible mounting plate
colour: inox
material: stainless steel

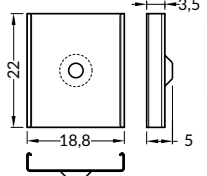
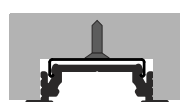

inox
A2130019



HALTER / MOUNTINGS

Halter T
Farben: Rohaluminium
Material: Aluminium

T mounting plate
colour: raw aluminium
material: aluminium

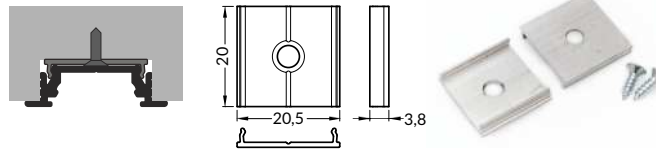

Artikelnummer = 10 Sets = 20 Stück
Verpackung > siehe bitte Preisliste
INDEX = 10 sets = 20 pcs
package > check the pricelist

Rohaluminium
raw aluminium
C6960000

ENDKAPPEN / ENDINGS

Endkappe GROOVE14 gen2 mit Öffnung
Farben: weiß, silbern, schwarz, grau
Material: ABS

GROOVE14 ending gen2 with hole
colours: white, silver, black, grey
material: ABS

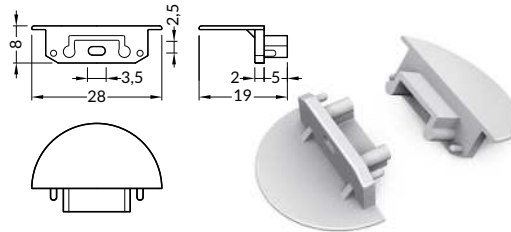

Artikelnummer = 10 Sets = 20 Stück
Verpackung > siehe bitte Preisliste
INDEX = 10 sets = 20 pcs
package > check the pricelist

weiß / white
A3970001
silbern / silver
A3970040
schwarz / black
A3970002
grau / grey
A3970022

Endkappe GROOVE14 gen2 SQ mit Öffnung
Farben: weiß, silbern, schwarz, grau
Material: ABS

GROOVE14 ending gen2 SQ with hole
colours: white, silver, black, grey
material: ABS

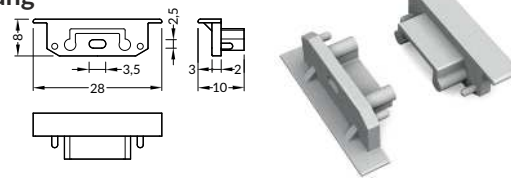

weiß / white
A3980001
silbern / silver
A3980040
schwarz / black
A3980002
grau / grey
A3980022

VERBINDUNGSTÜCKE / CONNECTOR

Verbindungsstück T 180 Grad
Farben: Rohaluminium
Material: Aluminium

T connector 180 deg
colour: raw aluminium
material: aluminium

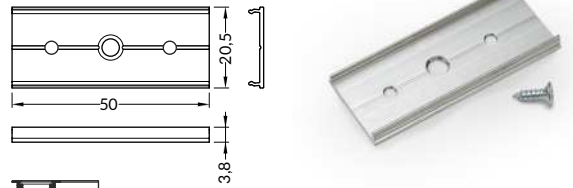

Artikelnummer = 1 Set
Verpackung > siehe bitte Preisliste
INDEX = 1 set
package > check the pricelist

Rohaluminium
raw aluminium
C6990000

Verbinder 90 Grad für GROOVE14
Farben: weiß, eloxiert, schwarz
Material: Aluminium

GROOVE14 connector 90 deg
colours: white, anodized, black
material: aluminium

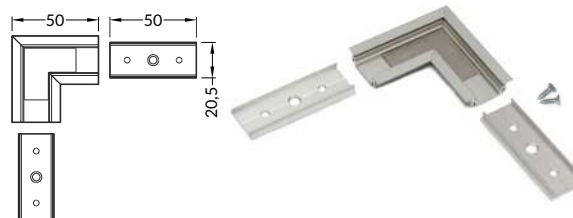

weiß lackiert
white painted
A3990001
eloxiert
anodized
A3990020
schwarz eloxiert
black anodized
A3990021



SMART-IN16 BC3/U4

ÖKONOMISCHES EINBAUPROFIL FÜR LED STREIFEN MIT 16mm

ECONOMICAL RECESSED PROFILE FOR 16 mm LED STRIP

- SLICK Befestigungssockel - einfache Montage der Abdeckung
- verschiedene Montageweisen
- eine homogene Lichtlinie (beim Gebrauch eines LED Streifens mit 120 P/m und einer opalen Abdeckung)
- maximale Breite des LED Streifens: 16 mm
- SLICK socket - easy assembly technology
- various ways of mounting
- continuous line of light (when using LED strip 120 P/m and opal cover)
- maximum width of LED strip: 16 mm



ÄHNLICHES IM ANGEBOT / SIMILAR IN THE OFFER



SMART16
BC3/U4



SMART-IN10
AC2/Z



BEGTIN12
J/S



GROOVE14
EF/TY



LINEA-IN20
EF/U7

B Abdeckung **B** einschiebbar
B slide cover

C3 Abdeckung **C3** einclipsbar
C3 click cover

U4¹ Halter **U4**
U4 mounting plate

U4² Halter **U4** cone
cone U4 mounting plate

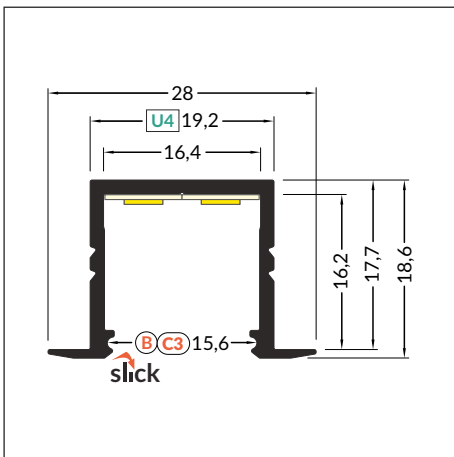
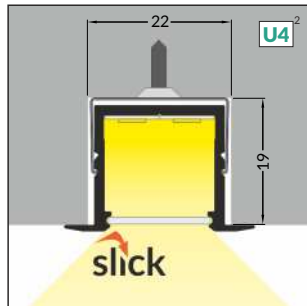
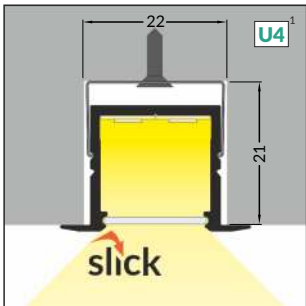
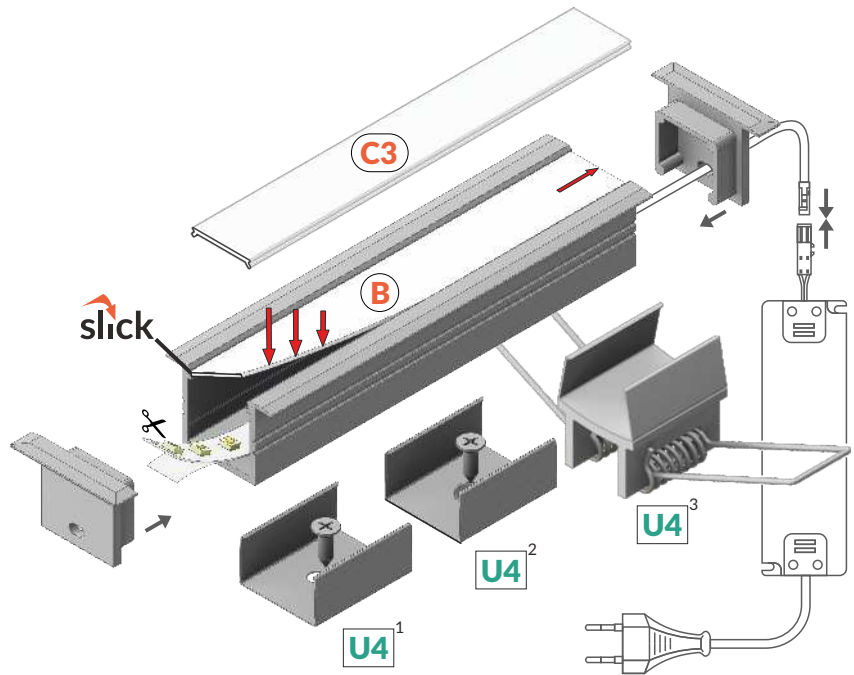

max 16 mm



Einbauprofile
recessed

Artikelnummer = 1 Stück, Länge 2.000 mm
Verpackung > siehe bitte Preisliste
INDEX = 1 pc, length 2000 mm
package > check the pricelist

weiß lackiert
white painted
F6000201

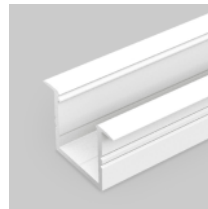

eloxiert
anodized
F6000220



Rohaluminium
raw aluminium
F6000200



Die zugänglichen Längen: 1000 mm, 2000 mm, 3000 mm, 4000 mm.
Die standardmäßige Toleranz der Länge von Profilen beträgt: +20 mm.
Mehr Informationen >> 1.08.

Available lengths: 1000 mm, 2000 mm, 3000 mm, 4000 mm.
The standard profile length tolerance is +20 mm.
More details >> 1.08.



ABDECKUNG / COVERS

Abdeckung B einziehbar
Farben: transparent, satiniert, opal
Material: PC, PP, PP

B slide cover
colours: transparent, frosted, opal
material: PC, PP, PP

Abdeckung C3 einclipsbar
Farben: transparent, opal
Material: PMMA

NEU

C3 click cover
colours: transparent, opal
material: PMMA



Achtung! Die Abmessungen des Platzes für die Montage von LED Lichtquelle
Note! Dimensions of the space to install LED source

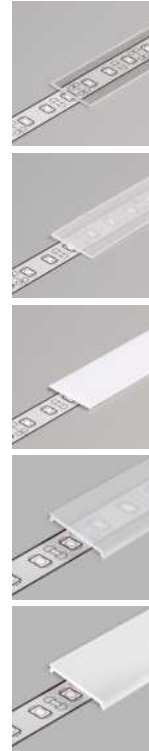
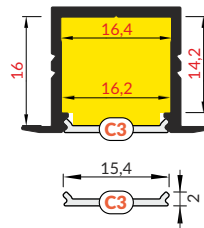
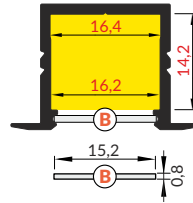

Länge 2.000 mm,
Verpackung > siehe bitte Preisliste
length 2000 mm
package > check the pricelist

B transparent
Artikelnummer = 10 Stück
index = 10 pcs

76250016

B satiniert / B frosted
Artikelnummer = 10 Stück
index = 10 pcs

76250039

B opal
Artikelnummer = 10 Stück
index = 10 pcs

76250038

C3 transparent
Artikelnummer = 1 Stück
index = 1 pc

F1000216

C3 opal
Artikelnummer = 1 Stück
index = 1 pc

F1000238

Die Toleranz der Länge von Abdeckungen beträgt: +20 mm.
Mehr Informationen >> 1.08.

The standard cover length tolerance is +20 mm.
More details >> 1.08.

ENDKAPPEN / ENDINGS

Endkappe SMART-IN16 mit Öffnung
Farben: weiß, silbern, grau
Material: ABS

SMART-IN16 ending with hole
colours: white, silver, grey
material: ABS

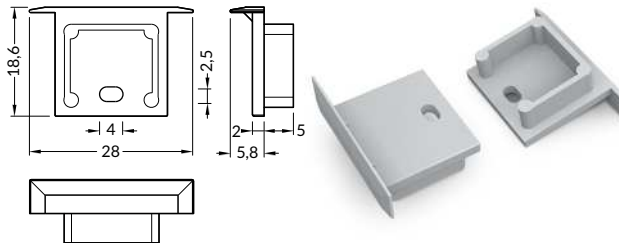

Artikelnummer = 10 Sets = 20 Stück
Verpackung > siehe bitte Preisliste
INDEX = 10 sets = 20 pcs
package > check the pricelist

weiß / white
F6009901

silbern / silver
F6009940

grau / grey
F6009922

HALTER / MOUNTINGS

Halter U4
Farben: weiß, inox
Material: rostfreier Stahl

U4 mounting plate
colour: white, inox
material: stainless steel

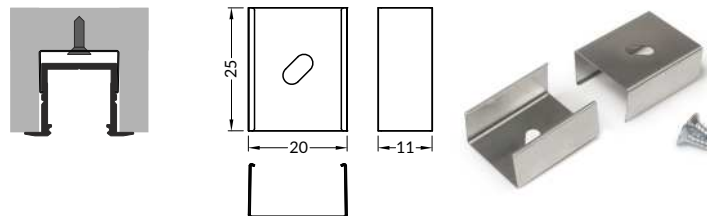

Artikelnummer = 10 Sets = 20 Stück
Verpackung > siehe bitte Preisliste
INDEX = 10 sets = 20 pcs
package > check the pricelist

weiß / white
F1970001

inox
F1970019

Halter U4 cone
Farben: weiß, inox
Material: rostfreier Stahl

cone **U4** mounting plate
colour: white, inox
material: stainless steel

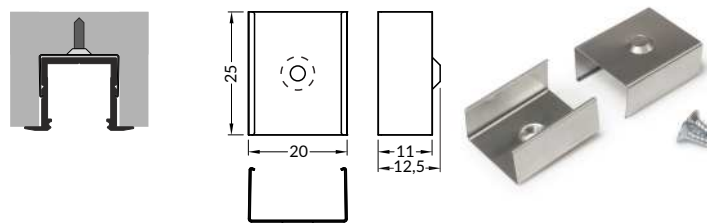

weiß / white
F1980001

inox
F1980019

ZUBEHÖR / ACCESSORIES

HALTER / MOUNTINGS

Halter **U4** Feder
Farben: inox
Material: rostfreier Stahl

spring **U4** mounting plate
colour: inox
material: stainless steel

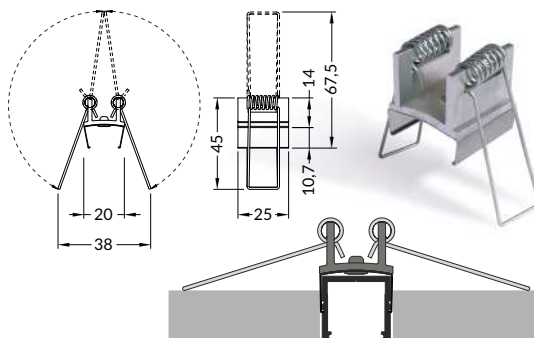

Artikelnummer = 1 Set = 2 Stück
Verpackung > siehe bitte Preisliste
INDEX = 1 set = 2 pcs
package > check the pricelist

inox
F6009819S



LINEA-IN20 EF/U7

BILDEN VON LICHTMODELLEN DANK DEN ECKVERBINDERN

CREATING LIGHTING PATTERNS THANKS TO ANGULAR CONNECTORS

- eine homogene Lichtlinie (bei LED Streifen mit 120 leds/m und einer opalen Abdeckung)
 - Lichtecken
 - mehr als 20 Zubehörteile
 - drei Möglichkeiten der Montage von LED Modulen:
mit einem Thermband, LED Modul auf einem Band, zusätzlich LED Klemme
 - maximale Breite des LED Streifens 20 mm
-
- continuous line of light (when using LED strip 120 P/m and opal cover)
 - angled connections illuminated
 - over 20 accessories available
 - 3 mounting options of LED modules: thermic tape, LED module on a strip, additionally LED clamp
 - maximum LED source width: 20 mm

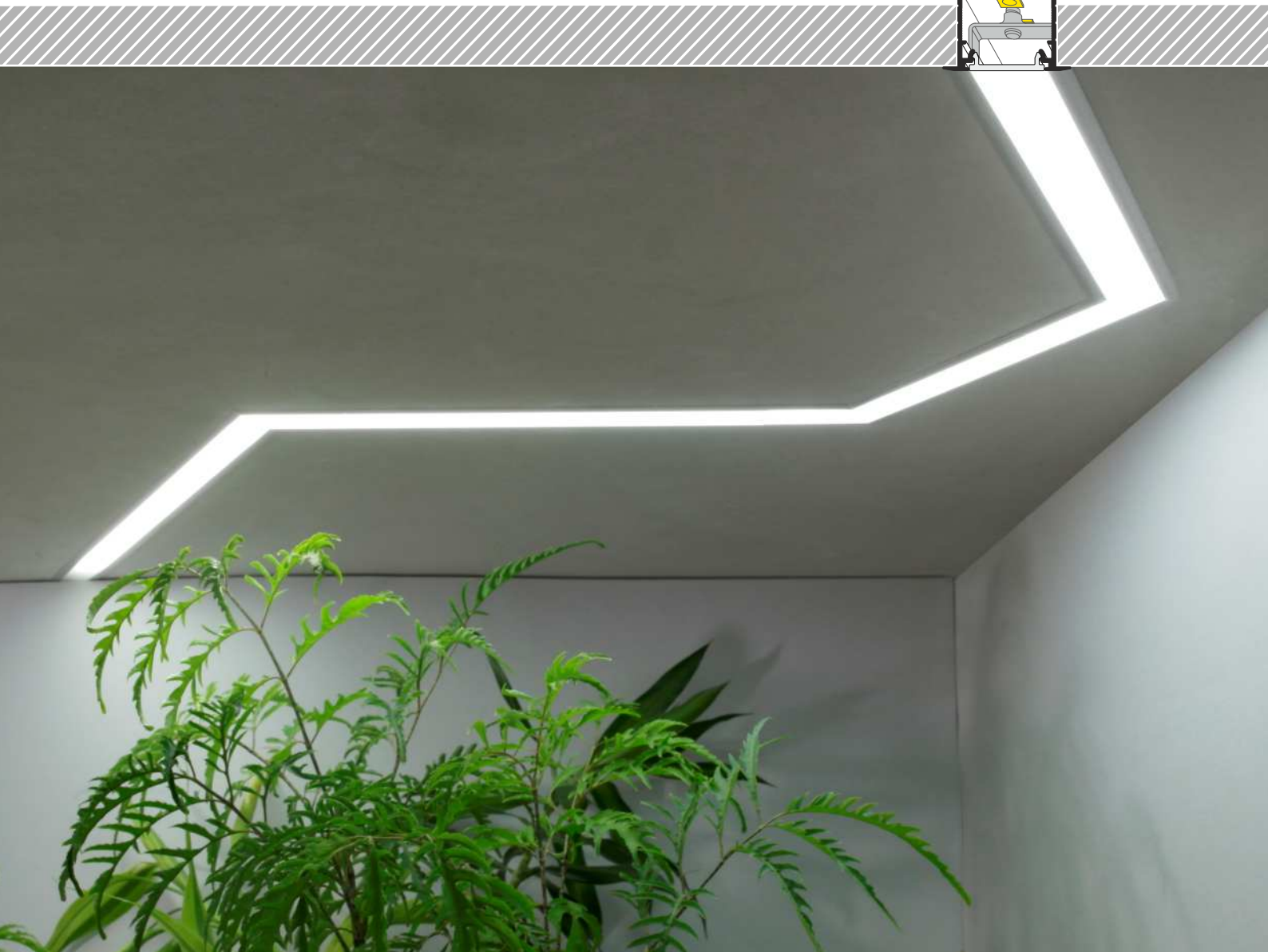
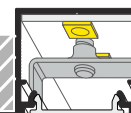

ÄHNLICHES IM ANGEBOT / SIMILAR IN THE OFFER





- E** Abdeckung E einziehbar
E slide cover
- F** Abdeckung F einclipsbar
F click cover
- E7** Abdeckung E7 einclipsbar
E7 click cover
- U7**¹ Halter U7
U7 mounting plate
- U7**² Halter U7 cone
cone U7 mounting plate
- U7**³ Halter U7 rack
rack U7 mounting plate
- U7**⁴ Halter U7 Feder
spring U7 mounting plate

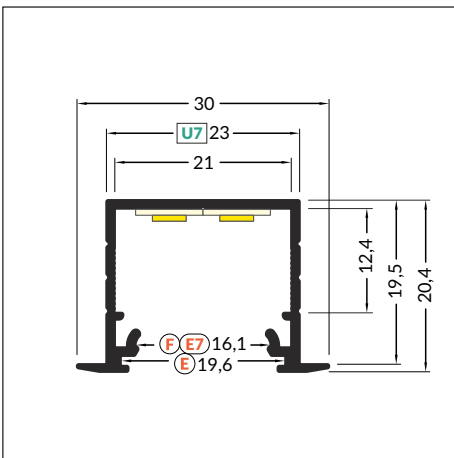
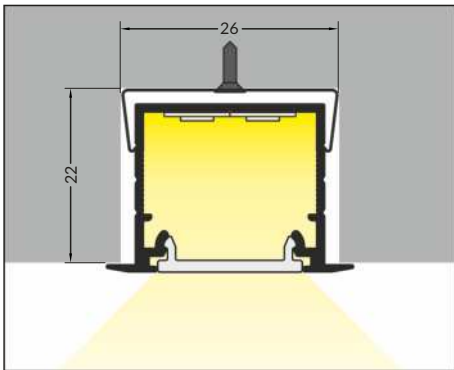
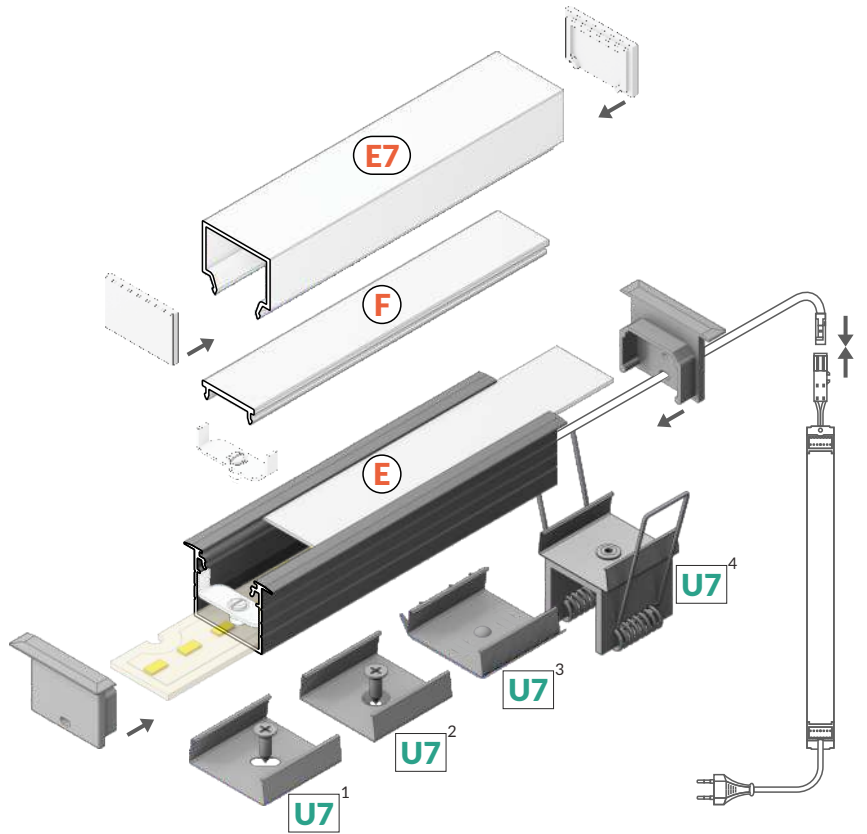

Artikelnummer = 1 Stück, Länge 2.000 mm
Verpackung > siehe bitte Preisliste
INDEX = 1 pc, length 2000 mm
package > check the pricelist

weiß lackiert
white painted
E4020001



eloxiert
anodized
E4020020



schwarz eloxiert
black anodized
E4020021



Rohaluminium
raw aluminium
E4020000



max 20 mm



Einbauprofile
recessed

Die zugänglichen Längen: 1000 mm, 2000 mm, 3000 mm, 4000 mm.
Die standardmäßige Toleranz der Länge von Profilen beträgt: +20 mm.
Mehr Informationen >> 1.08.

Available lengths: 1000 mm, 2000 mm, 3000 mm, 4000 mm.
The standard profile length tolerance is +20 mm.
More details >> 1.08.



ABDECKUNG / COVERS

Abdeckung E einziehbar
Farben: transparent, satiniert, opal
Material: PC, PP, PP

E slide cover
colours: transparent, frosted, opal
material: PC, PP, PP



Achtung! Die Abmessungen des Platzes für die Montage von LED Lichtquelle
Note! Dimensions of the space to install LED source

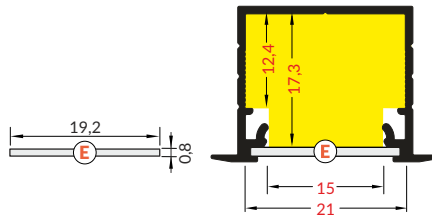

Länge 2.000 mm,
Verpackung > siehe bitte Preisliste
length 2000 mm
package > check the pricelist

E transparent
Artikelnummer = 10 Stück
index = 10 pcs
A2040016

E satiniert / **E** frosted
Artikelnummer = 10 Stück
index = 10 pcs
A2040039

E opal
Artikelnummer = 10 Stück
index = 10 pcs
A2040038

Abdeckung F einclipsbar
Farben: transparent, opal
Material: PMMA

F click cover
colours: transparent, opal
material: PMMA

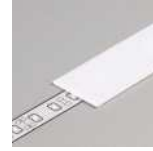
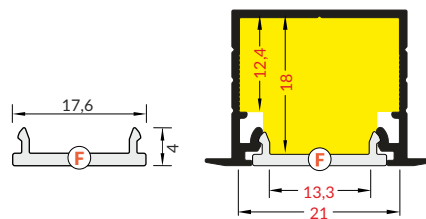

F transparent
Artikelnummer = 1 Stück
index = 1 pc
A2060016

F opal
Artikelnummer = 1 Stück
index = 1 pc
A2060038

NEU



Rolle, Länge 20 m,
Verpackung > siehe bitte Preisliste
reel, length 20 m
package > check the pricelist

F opal
Artikelnummer = 1 Stück
index = 1 pc
A2210038S

Abdeckung E7 einclipsbar
Farben: opal
Material: PMMA

E7 click cover
colour: opal
material: PMMA

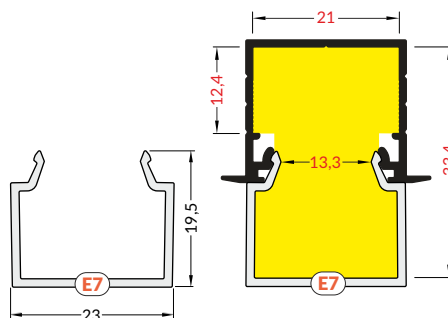

Länge 2.000 mm,
Verpackung > siehe bitte Preisliste
length 2000 mm
package > check the pricelist

E7 opal
Artikelnummer = 1 Stück
index = 1 pc
C1080038

Die Toleranz der Länge von Abdeckungen beträgt: +20 mm.
Mehr Informationen >> 1.08.

The standard cover length tolerance is +20 mm.
More details >> 1.08.

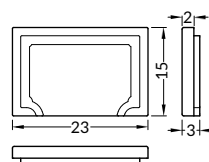

Artikelnummer = 1 Set = 2 Stück
Verpackung > siehe bitte Preisliste
INDEX = 1 set = 2 pcs
package > check the pricelist

Endkappe **E7** opal
E7 opal ending
C1840038

ENDKAPPEN / ENDINGS

Endkappe LINEA-IN20 mit Öffnung
Farben: weiß, silbern, schwarz, grau
Material: ABS

LINEA-IN20 ending with hole
colours: white, silver, black, grey
material: ABS

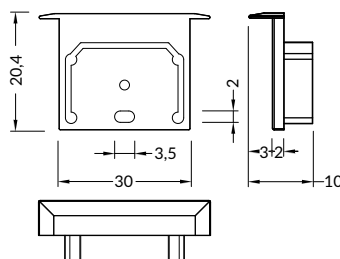

Artikelnummer = 10 Sets = 20 Stück
Verpackung > siehe bitte Preisliste
INDEX = 10 sets = 20 pcs
package > check the pricelist

weiß / white
E4990001

silbern / silver
E4990040

schwarz / black
E4990002

grau / grey
E4990022



ENDKAPPEN / ENDINGS

Endkappe LINEA-IN20-E7 mit Öffnung NEU
Farben: weiß, silbern, schwarz, grau
Material: ABS
 LINEA-IN20-E7 ending with hole
 colours: white, silver, black, grey
 material: ABS

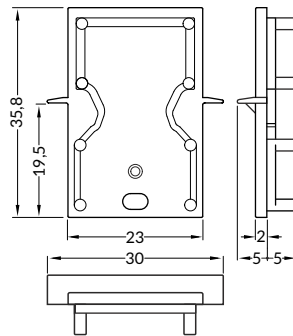

Artikelnummer = 10 Sets = 20 Stück
 Verpackung > siehe bitte Preisliste
 INDEX = 10 sets = 20 pcs
 package > check the pricelist

weiß / white
E4999901
 silbern / silver
E4999940
 schwarz / black
E4999902
 grau / grey
E4999922

HALTER / MOUNTINGS

Halter U7
Farben: inox
Material: rostfreier Stahl
 U7 mounting plate
 colour: inox
 material: stainless steel

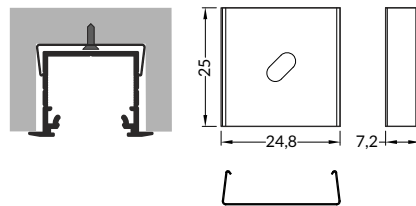

Artikelnummer = 10 Sets = 20 Stück
 Verpackung > siehe bitte Preisliste
 INDEX = 10 sets = 20 pcs
 package > check the pricelist

inox
E4960019

Halter U7 cone
Farben: inox
Material: rostfreier Stahl
 cone U7 mounting plate
 colour: inox
 material: stainless steel

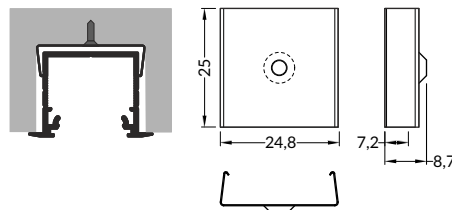

inox
E4970019

Halter U7 rack
Farben: inox
Material: rostfreier Stahl
 rack U7 mounting plate
 colour: inox
 material: stainless steel

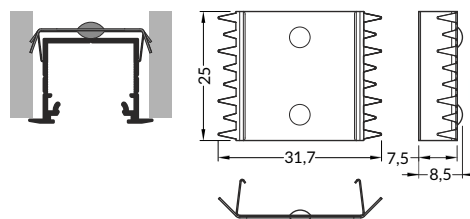

inox
E4980019

Halter U7 Feder
Farben: inox
Material: rostfreier Stahl
 spring U7 mounting plate
 colour: inox
 material: stainless steel

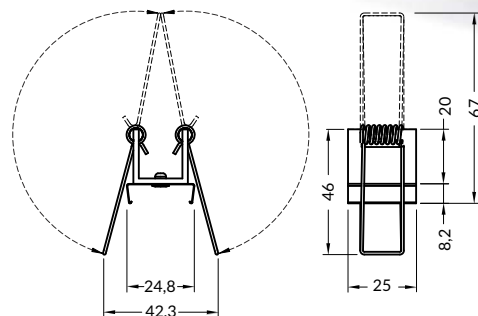
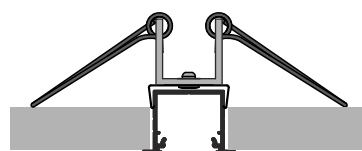

Artikelnummer = 1 Set = 2 Stück
 Verpackung > siehe bitte Preisliste
 INDEX = 1 set = 2 pcs
 package > check the pricelist

inox
E4880019s

LINEA-IN20 EF/U7

VERBINDUNGSMÖGLICHKEITEN CONNECTION POSSIBILITY



60°



90°



120°



135°



180°

ECKVERBINDER

Dank den Eckverbindern mit fünf unterschiedlichen Winkeln (60° / 90° / 120° / 135° / 180°) möglich ist die Bildung von vielen unterschiedlichen Lichtvarianten ohne das Profil auf Gehrung zuschneiden müssen.

Gebogene Verbindungsstücke ermöglichen das Verbinden von zwei Profilen in zwei Ebenen, unter zwei Winkeln; dem inneren Winkel von 90° und dem äußeren Winkel von 270°.

ANGULAR CONNECTORS

Thanks to five different angle connectors (60° / 90° / 120° / 135° / 180°) it is possible to create many various lighting systems – with no need to cut the profile at an angle.

Bent connectors allows to connect profiles in two planes, at two angles: 90° on the inside and 270° on the outside.

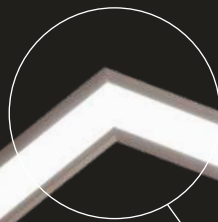

Ein Element aus durchsichtigem Kunststoff sichert die Stabilisierung der Verbindung und gleichzeitig lässt das Licht durch. Diese Lösung ermöglicht das Leuchten der Gehäuse auf der ganzen Fläche - auch in den Ecken.

The component made of clear fabric provides secure connection, letting light through at the same time. Thanks to that, the luminaire can illuminate on the entire surface of the cover – even in the corners.



VERBINDUNGSTÜCKE / CONNECTORS

Verbinder 60 Grad für LINEA-IN20
Farben: weiß, eloxiert, schwarz
Material: Aluminium, Polycarbonat

LINEA-IN20 connector 60 deg
colours: white, anodized, black
material: aluminium, polycarbonate

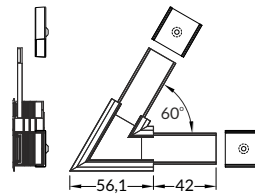

Artikelnummer = 1 Set
Verpackung > siehe bitte Preisliste
INDEX = 1 set
package > check the pricelist

weiß lackiert / white painted
E4890001s

eloxiert / anodized
E4890002s

schwarz eloxiert / black anodized
E48900021s

Verbinder 90 Grad für LINEA-IN20
Farben: weiß, eloxiert, schwarz
Material: Aluminium, Polycarbonat

LINEA-IN20 connector 90 deg
colours: white, anodized, black
material: aluminium, polycarbonate

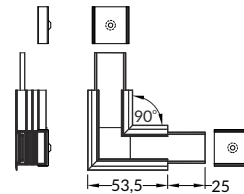

weiß lackiert / white painted
E4900001s

eloxiert / anodized
E4900002s

schwarz eloxiert / black anodized
E49000021s

Verbinder 90 Grad für LINEA-IN20 gebogen
Farben: weiß, eloxiert, schwarz
Material: Aluminium, Polycarbonat

LINEA-IN20 connector 90 deg bent
colours: white, anodized, black
material: aluminium, polycarbonate

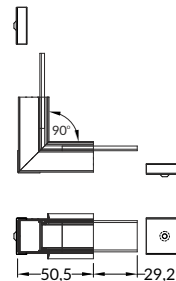

weiß lackiert / white painted
E4910001s

eloxiert / anodized
E4910002s

schwarz eloxiert / black anodized
E49100021s

Verbinder 120 Grad für LINEA-IN20
Farben: weiß, eloxiert, schwarz
Material: Aluminium, Polycarbonat

LINEA-IN20 connector 120 deg
colours: white, anodized, black
material: aluminium, polycarbonate

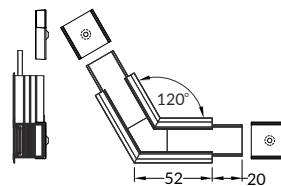

weiß lackiert / white painted
E4920001s

eloxiert / anodized
E4920002s

schwarz eloxiert / black anodized
E49200021s

Verbinder 135 Grad für LINEA-IN20
Farben: weiß, eloxiert, schwarz
Material: Aluminium, Polycarbonat

LINEA-IN20 connector 135 deg
colours: white, anodized, black
material: aluminium, polycarbonate

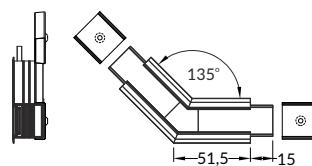

weiß lackiert / white painted
E4930001s

eloxiert / anodized
E4930002s

schwarz eloxiert / black anodized
E49300021s

Verbinder 180 Grad für LINEA-IN20
Material: Polycarbonat

LINEA-IN20 connector 180 deg
material: polycarbonate



E4940000s

Verbinder 270 Grad für LINEA-IN20 gebogen
Farben: weiß, eloxiert, schwarz
Material: Aluminium, Polycarbonat

LINEA-IN20 connector 270 deg bent
colours: white, anodized, black
material: aluminium, polycarbonate

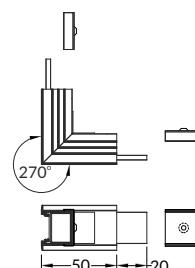

weiß lackiert / white painted
E4950001s

eloxiert / anodized
E4950002s

schwarz eloxiert / black anodized
E49500021s



KLEMME / CLAMP

Klemme für LEDs für LINEA20

Farben: weiß
Material: Stahl, Kunststoff

LINEA20 LED clamp
colour: white
material: painted steel, plastic

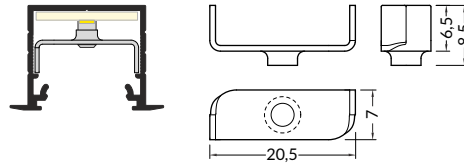

Klemme für LEDs für LINEA20-1

Farben: weiß
Material: Stahl, Kunststoff

LINEA20-1 LED clamp
colour: white
material: painted steel, plastic

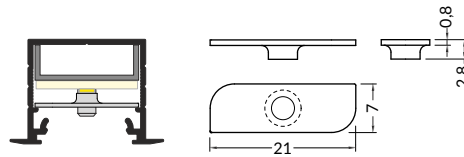

Artikelnummer = 1 Set = 2 Stück
Verpackung > siehe bitte Preisliste
INDEX = 1 set = 2 pcs
package > check the pricelist

weiß / white
C6940001

weiß / white
C6930001

MONTAGETEIL FÜR LED / LED MOUNTING

Montageteil LED für LINEA20

Material: Aluminium

Montageteil LED für LINEA20

Material: Aluminium

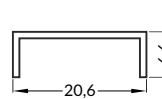

Artikelnummer = 1 Stück, Länge 2.000 mm
Verpackung > siehe bitte Preisliste
INDEX = 1 pc, length 2000 mm
package > check the pricelist

Rohaluminium
raw aluminium
C6060000

Die zugänglichen Längen: 1000 mm, 2000 mm, 3000 mm, 4000 mm. Die standardmäßige Toleranz der Länge von Profilen beträgt: +20 mm. Mehr Informationen >> 1.08.

Available lengths: 1000 mm, 2000 mm, 3000 mm, 4000 mm. The standard profile length tolerance is +20 mm. More details >> 1.08.

LEUCHTEFFEKT / LIGHTING EFFECT

LED Montageteil für LINEA20 + LED Klemme LINEA20-1 / LINEA20 LED mounting + LINEA20-1 LED clamp



Leuchteffekt ohne die Einschiebepatte für LED bei dem Profil LINEA20 zu verwenden / Lighting effect without LINEA20 LED mounting



EINE HOMOGENE LICHTLINIE
bei LED Streifen mit 120 leds/m und einer opalen Abdeckung

CONTINUOUS LIGHT OF LINE
when using LED strip 120 P/m and opal cover



LINEA-IN20 TRIMLESS EF

GERINGERE SICHTBARKEIT DES PROFILRANDES

REDUCED VISIBILITY OF PROFILE EDGE

- für Spachteltechnik
- SLICK Befestigungssockel - einfache Montage der Abdeckung
- drei Möglichkeiten der Montage von LED Modulen
- eine homogene Lichtlinie (beim Gebrauch eines LED Streifens mit 120 P/m und einer opalen Abdeckung)
- maximale Breite des LED Streifens: 20 mm

- for spackle flange mounting
- Slick socket - easy assembly technology
- 3 mounting options of LED modules
- continuous line of light (when using LED strip 120 P/m and opal cover)
- maximum LED source width: 20 mm



ÄHNLICHES IM ANGEBOT / SIMILAR IN THE OFFER



LINEA20
EF/TY

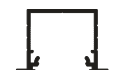

LINEA-IN20
EF/U7

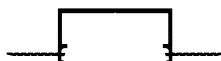

VARIO30-04



VARIO30-05

- E** Abdeckung **E** einziehbar
E slide cover
- F** Abdeckung **F** einclipsbar
F click cover
- E7** Abdeckung **E7** einclipsbar
E7 click cover

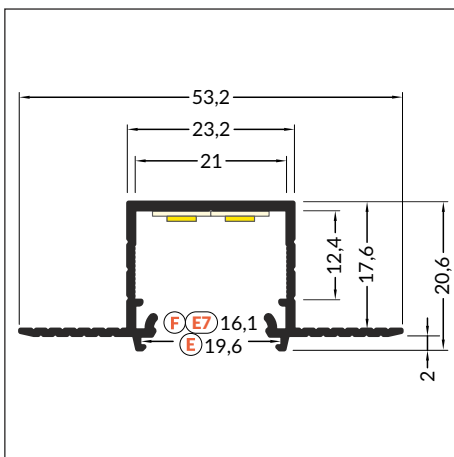
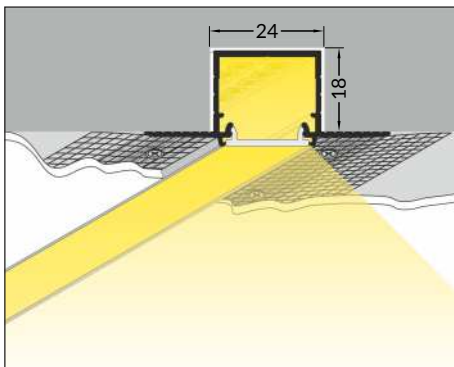
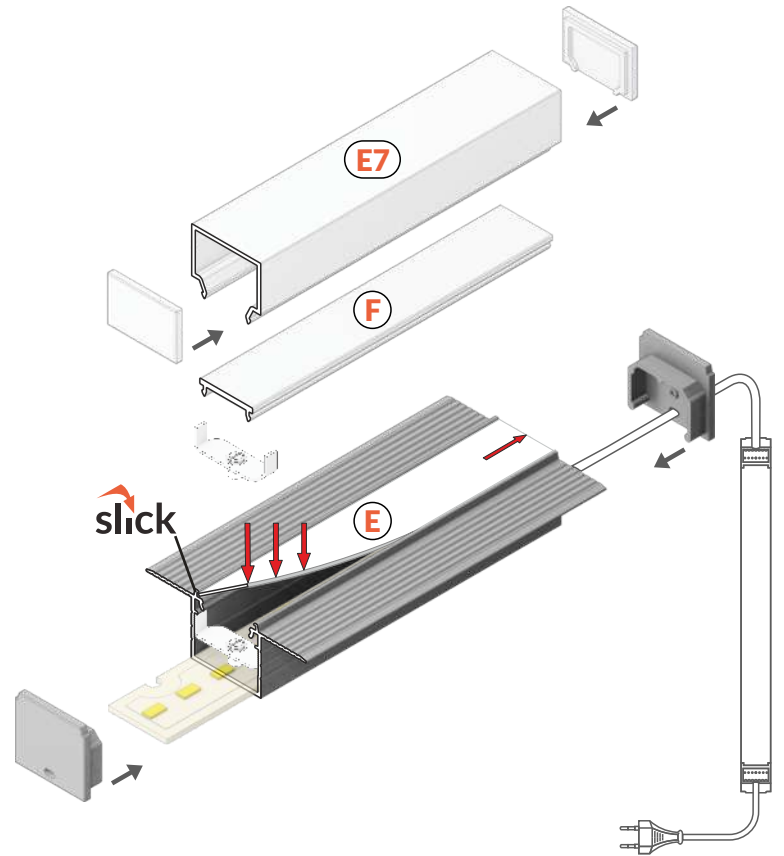

max 20 mm



Einbauprofile
recessed



Artikelnummer = 1 Stück, Länge 2.000 mm
Verpackung > siehe bitte Preisliste
INDEX = 1 pc, length 2000 mm
package > check the pricelist

weiß lackiert
white painted

G1000201



eloxiert
anodized

G1000220



Rohaluminium
raw aluminium

G1000200

Die zugänglichen Längen: 1000 mm, 2000 mm, 3000 mm, 4000 mm.
Die standardmäßige Toleranz der Länge von Profilen beträgt: +20 mm.
Mehr Informationen >> 1.08.

Available lengths: 1000 mm, 2000 mm, 3000 mm, 4000 mm.
The standard profile length tolerance is +20 mm.
More details >> 1.08.



ABDECKUNG / COVERS

Abdeckung E einziehbar
Farben: transparent, satiniert, opal
Material: PC, PP, PP

E slide cover
colours: transparent, frosted, opal
material: PC, PP, PP

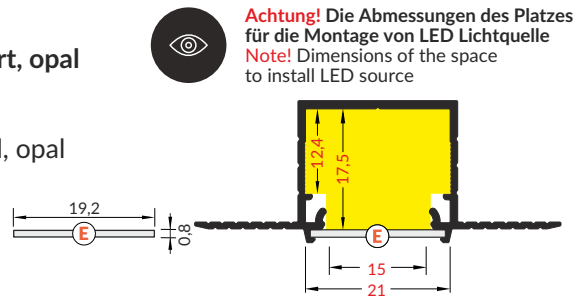

Achtung! Die Abmessungen des Platzes für die Montage von LED Lichtquelle
Note! Dimensions of the space to install LED source

Abdeckung F einclipsbar
Farben: transparent, opal
Material: PMMA

F click cover
colours: transparent, opal
material: PMMA

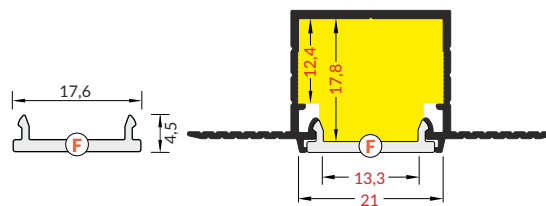

Abdeckung E7 einclipsbar
Farben: opal
Material: PMMA

E7 click cover
colour: opal
material: PMMA

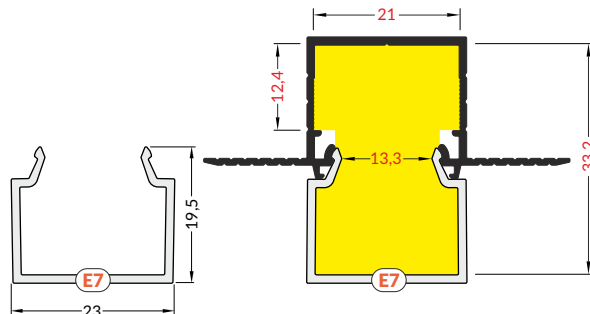

NEU

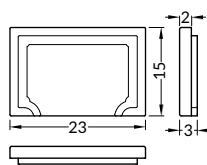

ENDKAPPE / ENDINGS

Endkappe LINEA-IN20 TRIMLESS mit Öffnung
Farben: weiß, silbern, grau
Material: ABS

LINEA-IN20 TRIMLESS ending with hole
colours: white, silver, grey
material: ABS

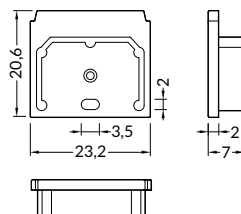

Länge 2.000 mm,
Verpackung > siehe bitte Preisliste
length 2000 mm
package > check the pricelist

E transparent

Artikelnummer = 10 Stück
index = 10 pcs

A2040016

E satiniert / **E** frosted

Artikelnummer = 10 Stück
index = 10 pcs

A2040039

E opal

Artikelnummer = 10 Stück
index = 10 pcs

A2040038

F transparent

Artikelnummer = 1 Stück
index = 1 pc

A2060016

F opal

Artikelnummer = 1 Stück
index = 1 pc

A2060038

Rolle, Länge 20 m,
Verpackung > siehe bitte Preisliste
reel, length 20 m
package > check the pricelist

F opal

Artikelnummer = 1 Stück
index = 1 pc

A2210038S

Länge 2.000 mm,
Verpackung > siehe bitte Preisliste
length 2000 mm
package > check the pricelist

E7 opal

Artikelnummer = 1 Stück
index = 1 pc

C1080038

Die Toleranz der Länge von Abdeckungen beträgt: +20 mm.
Mehr Informationen >> 1.08.

The standard cover length tolerance is +20 mm.
More details >> 1.08.

Artikelnummer = 1 Set = 2 Stück
Verpackung > siehe bitte Preisliste
INDEX = 1 set = 2 pcs
package > check the pricelist

Endkappe **E7** opal

E7 opal ending

C1840038

Artikelnummer = 10 Sets = 20 Stück
Verpackung > siehe bitte Preisliste
INDEX = 10 sets = 20 pcs
package > check the pricelist

weiß / white

G1000501

silbern / silver

G1000540

grau / grey

G1000522



KLEMME / CLAMP

Klemme für LEDs für LINEA20

Farben: weiß

Material: Stahl, Kunststoff

LINEA20 LED clamp

colour: white

material: painted steel, plastic

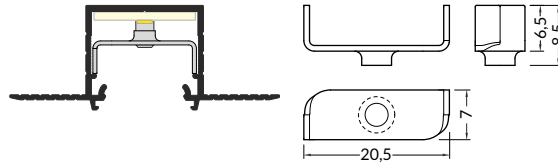

Klemme für LEDs für LINEA20-1

Farben: weiß

Material: Stahl, Kunststoff

LINEA20-1 LED clamp

colour: white

material: painted steel, plastic

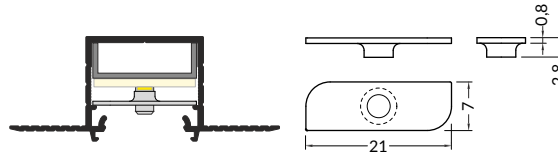

Artikelnummer = 1 Set = 2 Stück
Verpackung > siehe bitte Preisliste
INDEX = 1 set = 2 pcs
package > check the pricelist

weiß / white
C6940001

weiß / white
C6930001

MONTAGETEIL FÜR LED / LED MOUNTING

Montageteil LED für LINEA20

Material: Aluminium

LINEA20 LED mounting

material: aluminium

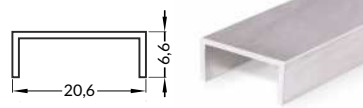

Artikelnummer = 1 Stück, Länge 2.000 mm
Verpackung > siehe bitte Preisliste
INDEX = 1 pc, length 2000 mm
package > check the pricelist

Rohaluminium
raw aluminium
C6060000

Die zugänglichen Längen: 1000 mm, 2000 mm, 3000 mm, 4000 mm. Die standardmäßige Toleranz der Länge von Profilen beträgt: +20 mm. Mehr Informationen >> 1.08.

Available lengths: 1000 mm, 2000 mm, 3000 mm, 4000 mm. The standard profile length tolerance is +20 mm. More details >> 1.08.



Welches Zubehör soll gewählt werden, um einen guten Leuchtergebnis zu erreichen?
>> 03.49

How to select accessories, to achieve proper lighting effect?
>> 03.49



2020

LED PROFILE
LED PROFILES

ECKPROFILE / CORNER



TRIO10 BC

ECKPROFIL 45°

ANGULAR PROFILE 45°

- für Vitrinenecken (Montage mit Schrauben)
- für Einbau (Befestigung mit Montageklebstoff)
- es eignet sich auch für die Beleuchtung von Treppen
- maximale Breite des LED Streifens 10 mm

- for display cases' corners (mounted with screws)
- recessed (mounted with adhesive glue)
- suitable also for lighting up steps
- maximum LED strip width: 10 mm

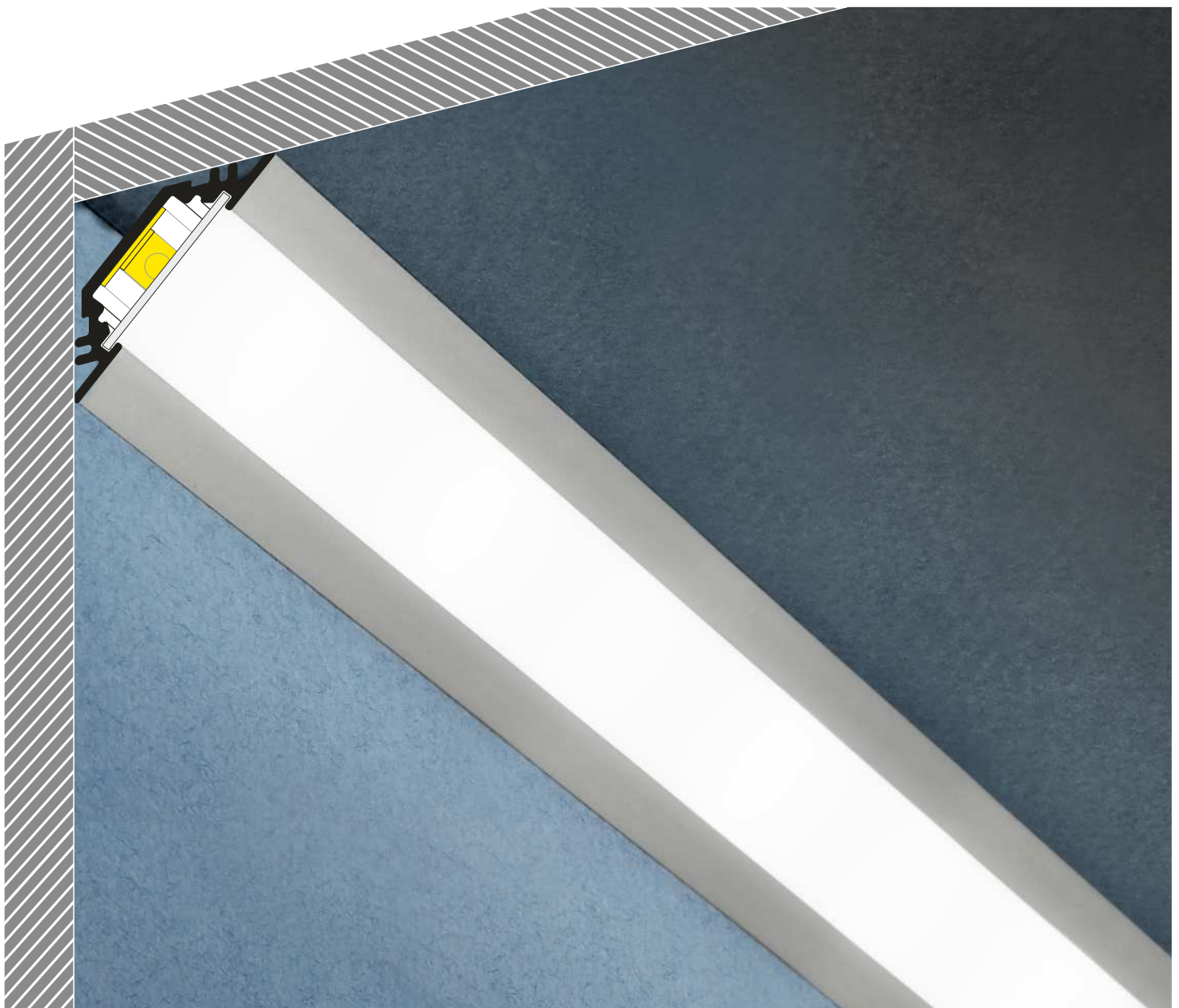

ÄHNLICHES IM ANGEBOT / SIMILAR IN THE OFFER



CORNER10
BC/UX



QUARTER10
BD/U6



CABI12
E



CORNER14
EF/TY



- B** Abdeckung **B** einschiebbar
B slide cover
- C** Abdeckung **C** einclipsbar
C click cover
- C** Abdeckung **C** einclipsbar Linse
C lens cover

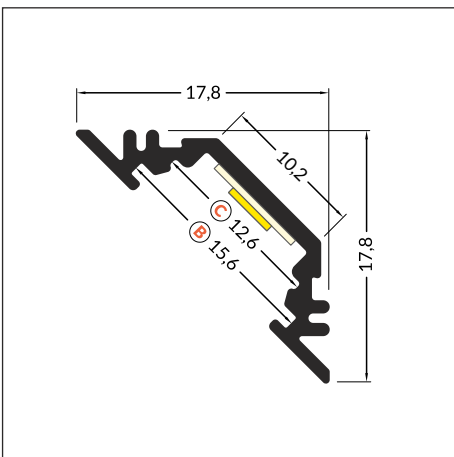
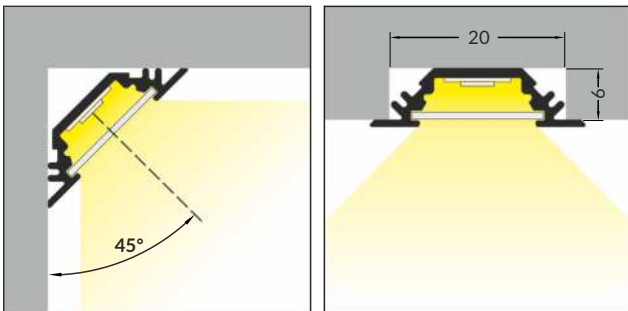
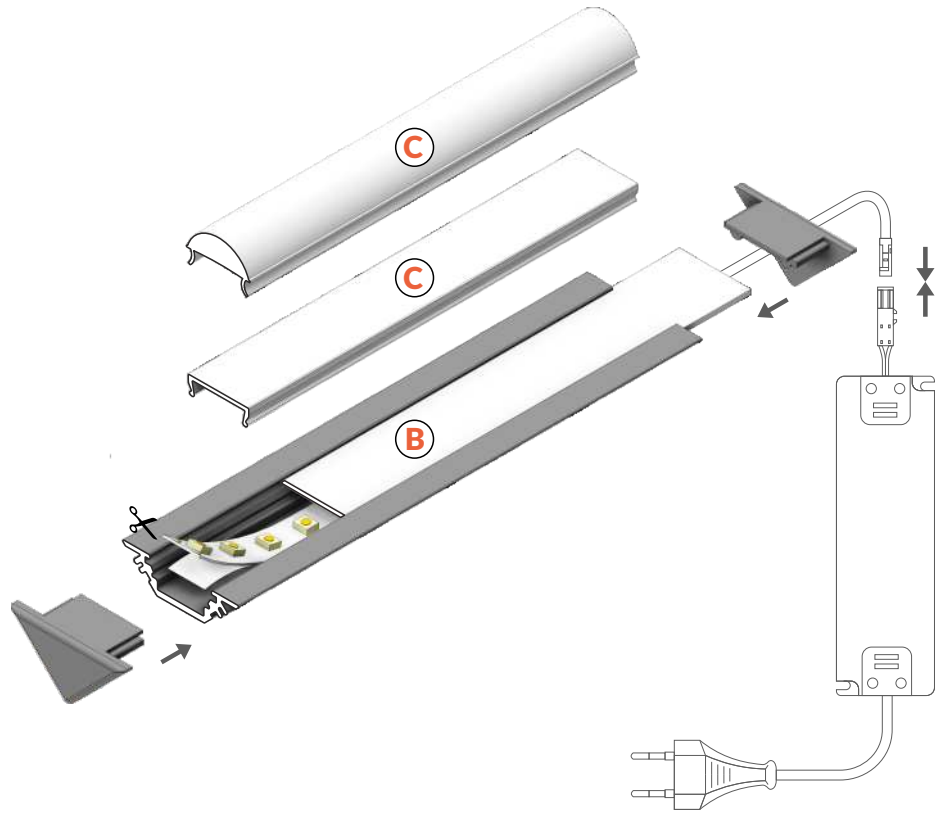

Artikelnummer = 1 Stück,
Länge 2.000 mm,
Verpackung > siehe bitte Preisliste
INDEX = 1 pc, length 2000 mm
package > check the pricelist

weiß lackiert
white painted
91030001



eloxiert
anodized
91030020



schwarz eloxiert
black anodized
91030021



Rohaluminium
raw aluminium
91030000

Die zugänglichen Längen: 1000 mm, 2000 mm, 3000 mm, 4000 mm.
Die standardmäßige Toleranz der Länge von Profilen beträgt: +20 mm.
Mehr Informationen >> 1.08.

Available lengths: 1000 mm, 2000 mm, 3000 mm, 4000 mm.
The standard profile length tolerance is +20 mm.
More details >> 1.08.



ABDECKUNG / COVERS

Abdeckung B einziehbar
Farben: transparent, satiniert, opal
Material: PC, PP, PP

B slide cover
colours: transparent, frosted, opal
material: PC, PP, PP



Achtung! Die Abmessungen des Platzes für die Montage von LED Lichtquelle
Note! Dimensions of the space to install LED source

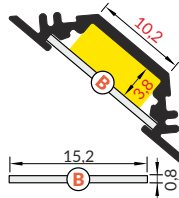

Länge 2.000 mm,
Verpackung > siehe bitte Preisliste
length 2000 mm
package > check the pricelist

B transparent
Artikelnummer = 10 Stück
index = 10 pcs
76250016



B satiniert / B frosted
Artikelnummer = 10 Stück
index = 10 pcs
76250039



B opal
Artikelnummer = 10 Stück
index = 10 pcs
76250038



C transparent
Artikelnummer = 1 Stück
index = 1 pc
76330000



C opal
Artikelnummer = 1 Stück
index = 1 pc
76330038

Abdeckung C einclipsbar
Farben: transparent, opal
Material: PMMA

C click cover
colours: transparent, opal
material: PMMA

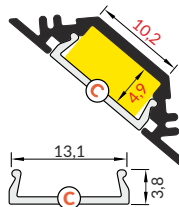

Rolle, Länge 20 m,
Verpackung > siehe bitte Preisliste
reel, length 20 m
package > check the pricelist

C opal
Artikelnummer = 1 Stück
index = 1 pc
76360038S



Länge 2.000 mm,
Verpackung > siehe bitte Preisliste
length 2000 mm
package > check the pricelist

C Linse / C lens
Artikelnummer = 1 Stück
index = 1 pc
76300000

Abdeckung C einclipsbar Linse
Farben: transparent
Material: PC

C lens click cover
colour: transparent
material: PC

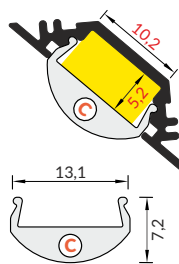

NEU

Die Toleranz der Länge von Abdeckungen beträgt: +20 mm.
Mehr Informationen >> 1.08.

The standard cover length tolerance is +20 mm.
More details >> 1.08.

ENDKAPPEN / ENDINGS

Endkappe TRIO10
Farben: weiß, silbern, schwarz, grau
Material: ABS
TRIO10 ending
colours: white, silver, black, grey
material: ABS

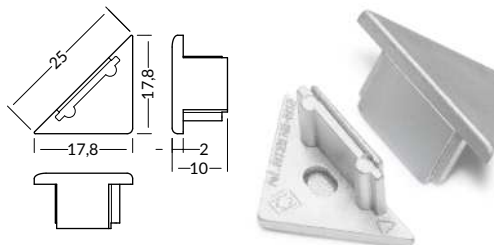

Die Endkappe mit Punkten für das Bohren von Öffnungen.
Ending with marked space to bore the holes.

Artikelnummer = 10 Sets = 20 Stück
Verpackung > siehe bitte Preisliste
INDEX = 10 sets = 20 pcs
package > check the pricelist

weiß / white
91060001

silbern / silver
91060040

schwarz / black
91060002

grau / grey
91060022

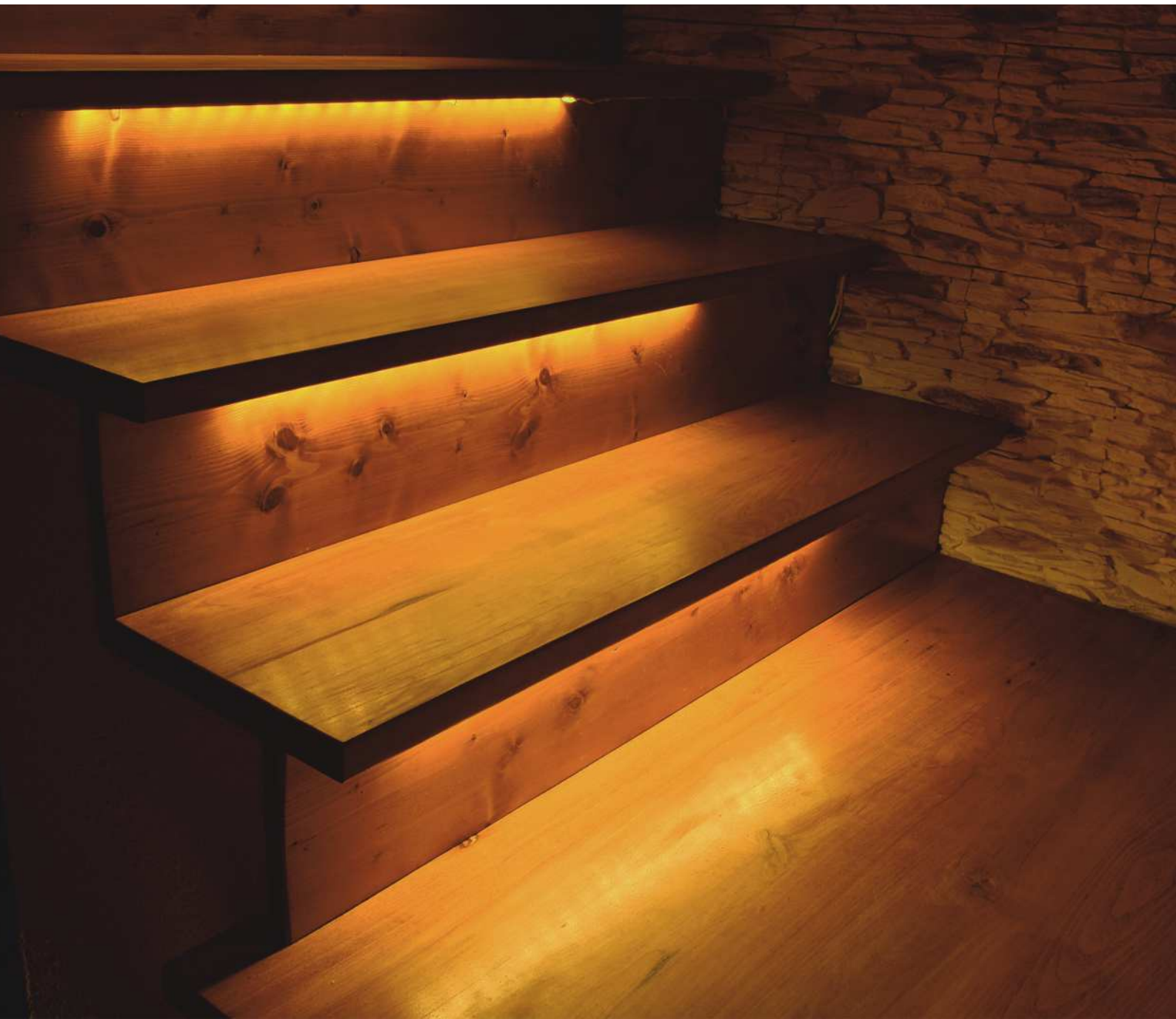

CORNER10 BC/UX

EIN KLEINES ALUMINIUMPROFIL FÜR ECKEN

SMALL, ALUMINIUM, ANGULAR PROFILE

- zwei Leuchtwinkel 30° und 60°
- eine versteckte Befestigung
- eine breite Zubehörwahl, 6 Arten der Abdeckungen
- maximale Breite des LED Streifens 10 mm

- lighting directions: 30° or 60°
- hidden mounting
- wide range of accessories, 6 types of covers
- maximum LED strip width: 10 mm



ÄHNLICHES IM ANGEBOT / SIMILAR IN THE OFFER



TRIO10
BC



QUARTER10
BD/UX



CABI12
E



CORNER14
EF/TY



CORNER27
G/UX



- B** Abdeckung **B** einschiebbar
B slide cover
- C** Abdeckung **C** einclipsbar
C click cover
- C** Abdeckung **C** einclipsbar Linse
C lens cover
- U**¹ Halter **U** flexibel
U flexible mounting plate
- U**² Halter **U** flexibel cone
cone U flexible mounting plate
- X**¹ Halter **X**
X mounting plate

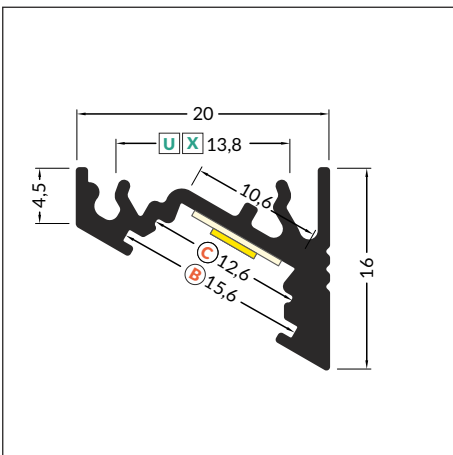
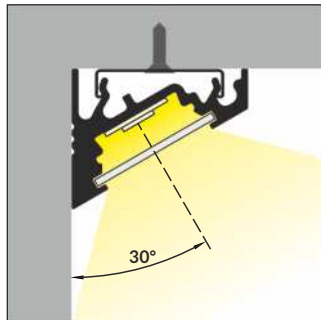
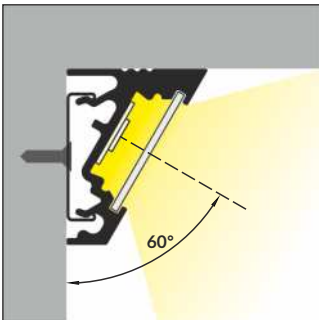
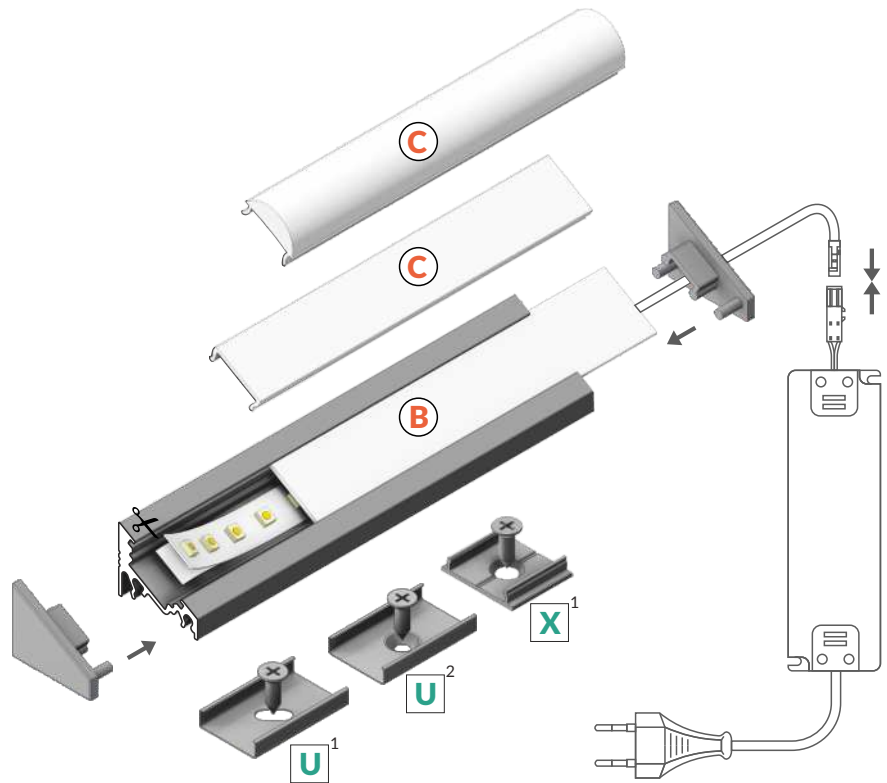

Artikelnummer = 1 Stück,
Länge 2.000 mm.
Verpackung > siehe bitte Preisliste
INDEX = 1 pc, length 2000 mm
package > check the pricelist

weiß lackiert
white painted
83050001

eloxiert
anodized
83050020

schwarz eloxiert
black anodized
83050021

Rohaluminium
raw aluminium
83050000

Die zugänglichen Längen: 1000 mm, 2000 mm, 3000 mm, 4000 mm.
Die standardmäßige Toleranz der Länge von Profilen beträgt: +20 mm.
Mehr Informationen >> 1.08.

Available lengths: 1000 mm, 2000 mm, 3000 mm, 4000 mm.
The standard profile length tolerance is +20 mm.
More details >> 1.08.



ABDECKUNG / COVERS

Abdeckung B einziehbar
Farben: transparent, satiniert, opal
Material: PC, PP, PP

B slide cover
colours: transparent, frosted, opal
material: PC, PP, PP

Abdeckung C einclipsbar
Farben: transparent, opal
Material: PMMA

C click cover
colours: transparent, opal
material: PMMA

Abdeckung C einclipsbar Linse
Farben: transparent
Material: PC

C lens click cover
colour: transparent
material: PC



Achtung! Die Abmessungen des Platzes für die Montage von LED Lichtquelle
Note! Dimensions of the space to install LED source

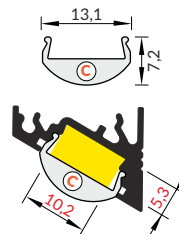
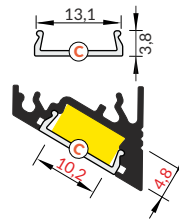
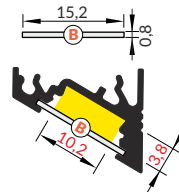

Länge 2.000 mm,
Verpackung > siehe bitte Preisliste
length 2000 mm
package > check the pricelist

B transparent
Artikelnummer = 10 Stück
index = 10 pcs
76250016

B satiniert / B frosted
Artikelnummer = 10 Stück
index = 10 pcs
76250039

B opal
Artikelnummer = 10 Stück
index = 10 pcs
76250038

C transparent
Artikelnummer = 1 Stück
index = 1 pc
76330000

C opal
Artikelnummer = 1 Stück
index = 1 pc
76330038

NEU



Rolle, Länge 20 m,
Verpackung > siehe bitte Preisliste
reel, length 20 m
package > check the pricelist

C opal
Artikelnummer = 1 Stück
index = 1 pc
76360038S



Länge 2.000 mm,
Verpackung > siehe bitte Preisliste
length 2000 mm
package > check the pricelist

C Linse / C lens
Artikelnummer = 1 Stück
index = 1 pc
76300000

Die Toleranz der Länge von Abdeckungen beträgt: +20 mm.
Mehr Informationen >> 1.08.
The standard cover length tolerance is +20 mm.
More details >> 1.08.

ENDKAPPEN / ENDINGS

Endkappe CORNER10 gen2
Farben: weiß, silbern, schwarz, grau
Material: ABS
CORNER10 ending gen2
colours: white, silver, black, grey
material: ABS

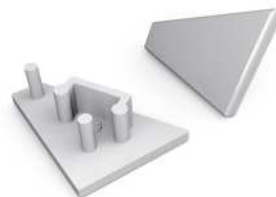
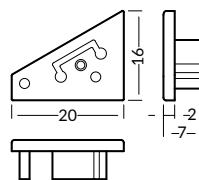

Artikelnummer = 10 Sets = 20 Stück
Verpackung > siehe bitte Preisliste
INDEX = 10 sets = 20 pcs
package > check the pricelist

weiß / white
83990001

silbern / silver
83990040

schwarz / black
83990002

grau / grey
83990022

Endkappe CORNER10 gen2 mit Öffnung
Farben: weiß, silbern, schwarz, grau
Material: ABS
CORNER10 ending gen2 with hole
colours: white, silver, black, grey
material: ABS

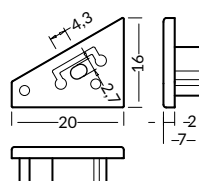

weiß / white
83980001

silbern / silver
83980040

schwarz / black
83980002

grau / grey
83980022



VERBINDUNGSTÜCKE / CONNECTORS

Verbindungsstück X 180 Grad
Farben: Rohaluminium
Material: Aluminium

X connector 180 deg
colour: raw aluminium
material: aluminium

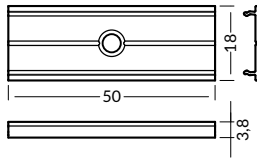

Artikelnummer = 1 Set
Verpackung > siehe bitte Preisliste
INDEKS = 1 set
package > check the pricelist

Rohaluminium
raw aluminium
76350000

Verbinder 90 Grad für CORNER10
Farben: weiß, eloxiert, schwarz
Material: Aluminium

CORNER10 connector 90 deg
colours: white, anodized, black
material: aluminium

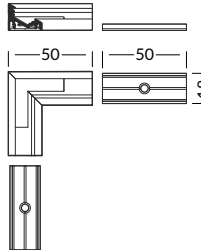

Artikelnummer = 1 Set
Verpackung > siehe bitte Preisliste
INDEKS = 1 set
package > check the pricelist

weiß lackiert
white painted
83110001

eloxiert
anodized
83110020

schwarz eloxiert
black anodized
83110021

HALTER / MOUNTINGS

Halter U flexibel
Farben: inox
Material: rostfreier Stahl

U flexible mounting plate
colours: inox
material: stainless steel

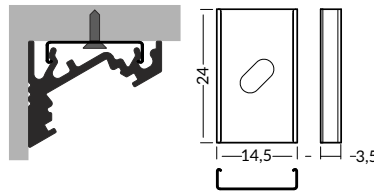

Artikelnummer = 10 Sets = 20 Stück
Verpackung > siehe bitte Preisliste
INDEX = 10 sets = 20 pcs
package > check the pricelist

inox
76380000

Halter U flexibel cone
Farben: inox
Material: rostfreier Stahl

cone U flexible mounting plate
colours: inox
material: stainless steel

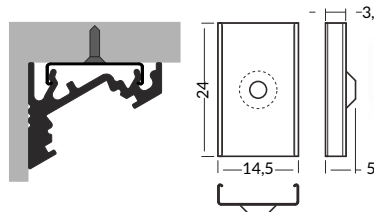

inox
76620000

Halter X
Farben: Rohaluminium
Material: Aluminium

X mounting plate
colours: raw aluminium
material: aluminium

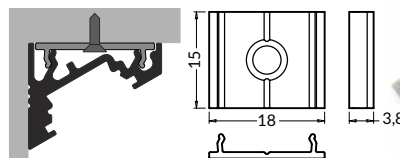

Rohaluminium
raw aluminium
76260000



QUARTER10 BD/U6

ECKLICHT

LIGHT FROM AN ANGLE

- volle Beleuchtung eines Viertels des Kreises
- die Band unter dem Winkel von 45 Grad gelegt
- Sockel mit Slick Funktion
- maximale Breite des LED Streifens 10 mm
- full circle quadrant illumination
- LED strip aligned to 45° angle
- Slick socket
- maximum LED strip width: 10 mm

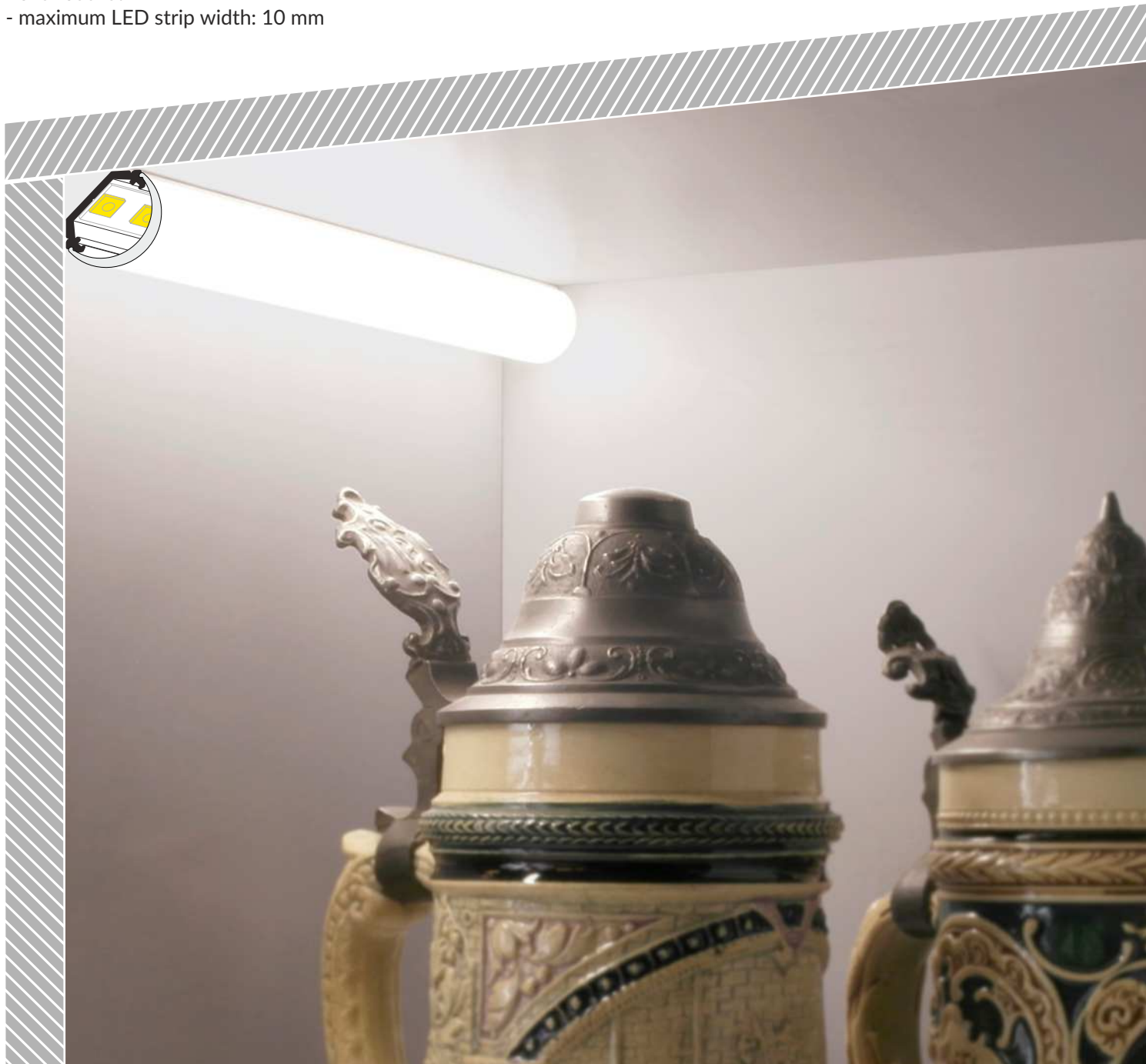

ÄHNLICHES IM ANGEBOT / SIMILAR IN THE OFFER



TRIO10
BC



CORNER10
BC/UX



CABI12
E



CORNER14
EF/TY



CORNER27
G/UX



B Abdeckung **B** einziehbar
B slide cover

D Abdeckung **D** einclipsbar
D click cover

U6¹ Halter **U6**
U6 mounting plate

U6² Halter **U6** cone
cone U6 mounting plate

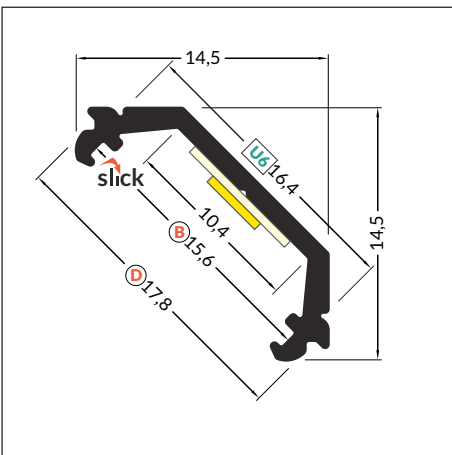
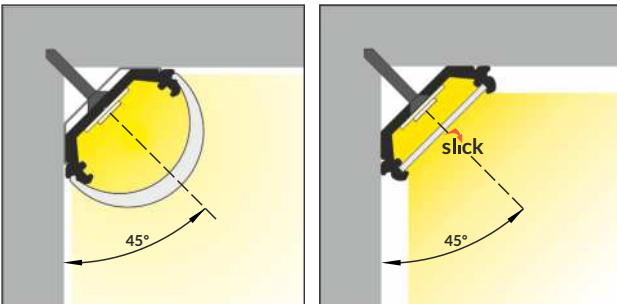
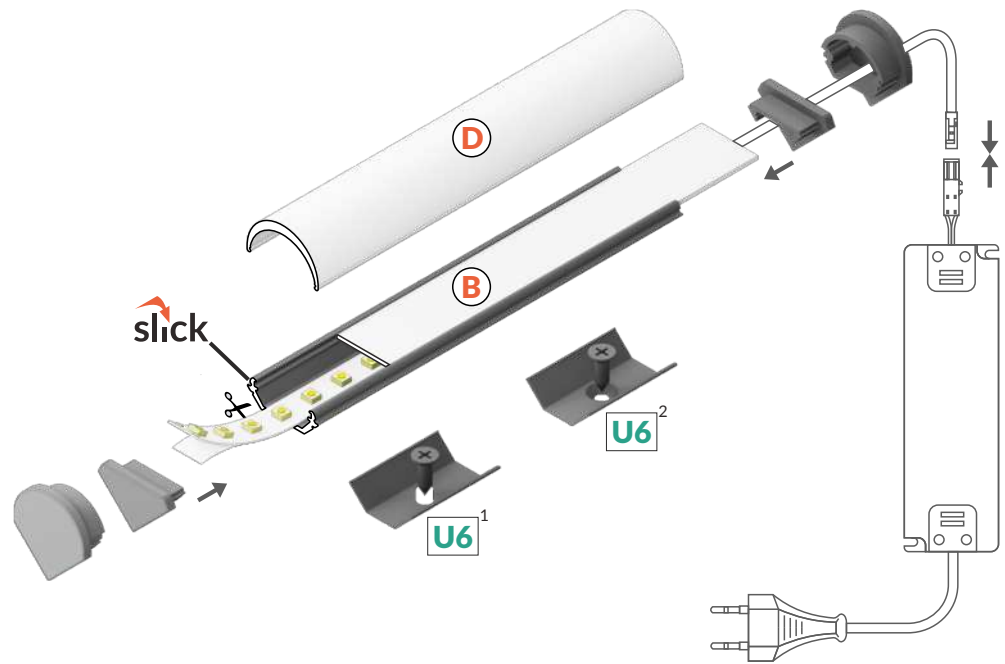

max 10 mm

Eckprofile
corner

Artikelnummer = 1 Stück,
Länge 2.000 mm,
Verpackung > siehe bitte Preisliste
INDEX = 1 pc, length 2000 mm
package > check the pricelist

eloxiert
anodized
D3020020

Die zugänglichen Längen: 1000 mm, 2000 mm, 3000 mm, 4000 mm.
Die standardmäßige Toleranz der Länge von Profilen beträgt: +20 mm.
Mehr Informationen >> 1.08.

Available lengths: 1000 mm, 2000 mm, 3000 mm, 4000 mm.
The standard profile length tolerance is +20 mm.
More details >> 1.08.



ABDECKUNG / COVERS

Abdeckung **B** einschiebbar
Farben: transparent, satiniert, opal
Material: PC, PP, PP

B slide cover
colours: transparent, frosted, opal
material: PC, PP, PP

Abdeckung **D** einclipsbar
Farben: opal
Material: PMMA

D slide cover
colours: opal
material: PMMA



Achtung! Die Abmessungen des Platzes für die Montage von LED Lichtquelle
Note! Dimensions of the space to install LED source

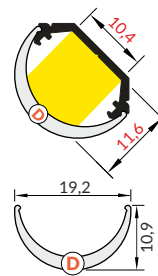
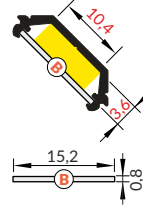

Länge 2.000 mm,
Verpackung > siehe bitte Preisliste
length 2000 mm
package > check the pricelist

B transparent
Artikelnummer = 10 Stück
index = 10 pcs
76250016

B satiniert / B frosted
Artikelnummer = 10 Stück
index = 10 pcs
76250039

B opal
Artikelnummer = 10 Stück
index = 10 pcs
76250038

D opal
Artikelnummer = 1 Stück
index = 1 pcs
A1140038

Die Toleranz der Länge von Abdeckungen beträgt: +20 mm.
Mehr Informationen >> 1.08.

The standard cover length tolerance is +20 mm.
More details >> 1.08.

ENDKAPPEN / ENDINGS

Endkappe QUARTER10
Farben: silbern, grau
Material: ABS
QUARTER10 ending
colours: silver, grey
material: ABS

Endkappe QUARTER10 D
Farben: silbern, grau
Material: ABS
QUARTER10 D ending
colours: silver, grey
material: ABS



Die Endkappe mit Punkten für das Bohren von Öffnungen.
Ending with marked space to bore the holes.

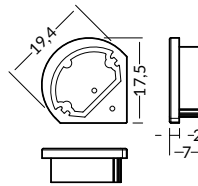
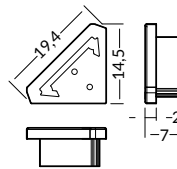

Artikelnummer = 10 Sets = 20 Stück
Verpackung > siehe bitte Preisliste
INDEX = 10 sets = 20 pcs
package > check the pricelist

silbern / silver
D3980040
grau / grey
D3980022

silbern / silver
D3990040
grau / grey
D3990022

HALTER / MOUNTINGS

Halter **U6**
Farben: inox
Material: rostfreier Stahl
U6 mounting plate
colours: inox
material: stainless steel

Halter **U6** cone
Farben: inox
Material: rostfreier Stahl
cone **U6** mounting plate
colours: inox
material: stainless steel

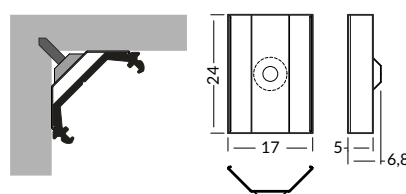
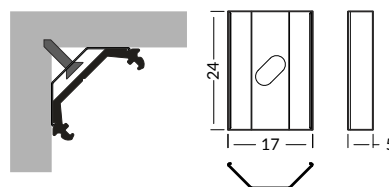

Artikelnummer = 10 Sets = 20 Stück
Verpackung > siehe bitte Preisliste
INDEX = 10 sets = 20 pcs
package > check the pricelist

inox
D3960019

inox
D3970019



EIN PROFIL FÜR DIE BELEUCHTUNG DES INNEREN DER VITRINE VERTIKAL UND HORIZONTAL

A PROFILE FOR SHOW CASE'S INSIDE VERTICAL AND HORIZONTAL ILLUMINATION

- zwei Leuchtwinkel 30° und 60°
- kleine Größe, keine Halter und ein Kabeldurchführungskanal - minimaler Eingriff in das Aussehen der Vitrine
- Sockel mit Slick Funktion
- maximale Breite des LED Streifens 12 mm
- two lighting angles: 30°/60°
- small sizes, no holders and a channel for hiding cables - minimum interference in glass show case's look
- Slick socket
- maximum LED strip width: 12 mm

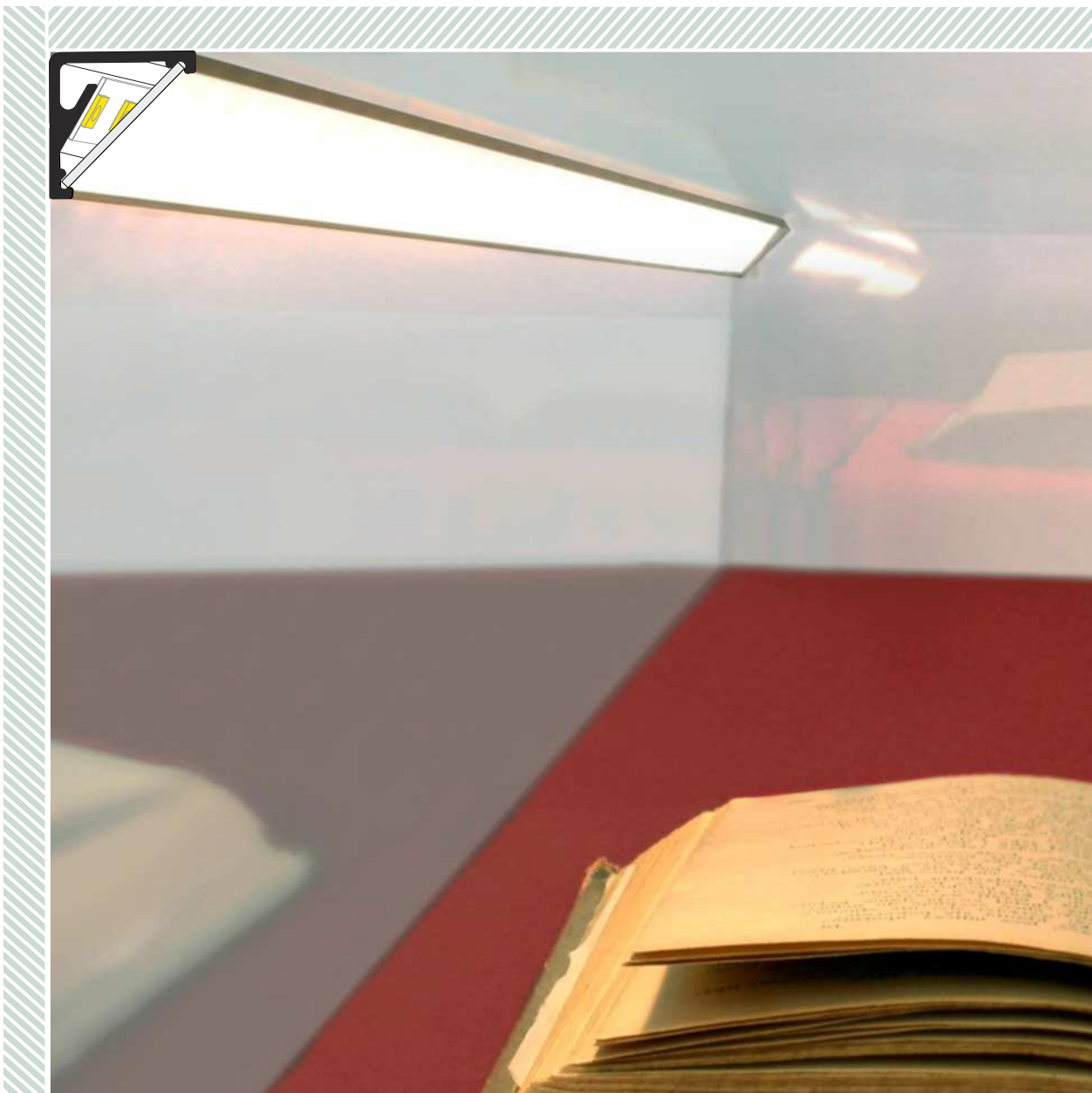

ÄHNLICHES IM ANGEBOT / SIMILAR IN THE OFFER





E Abdeckung **E** einziehbar
E slide cover

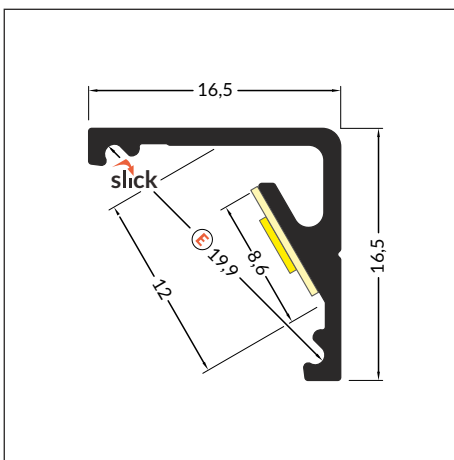
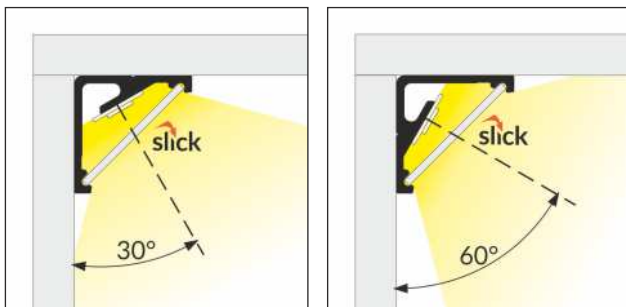
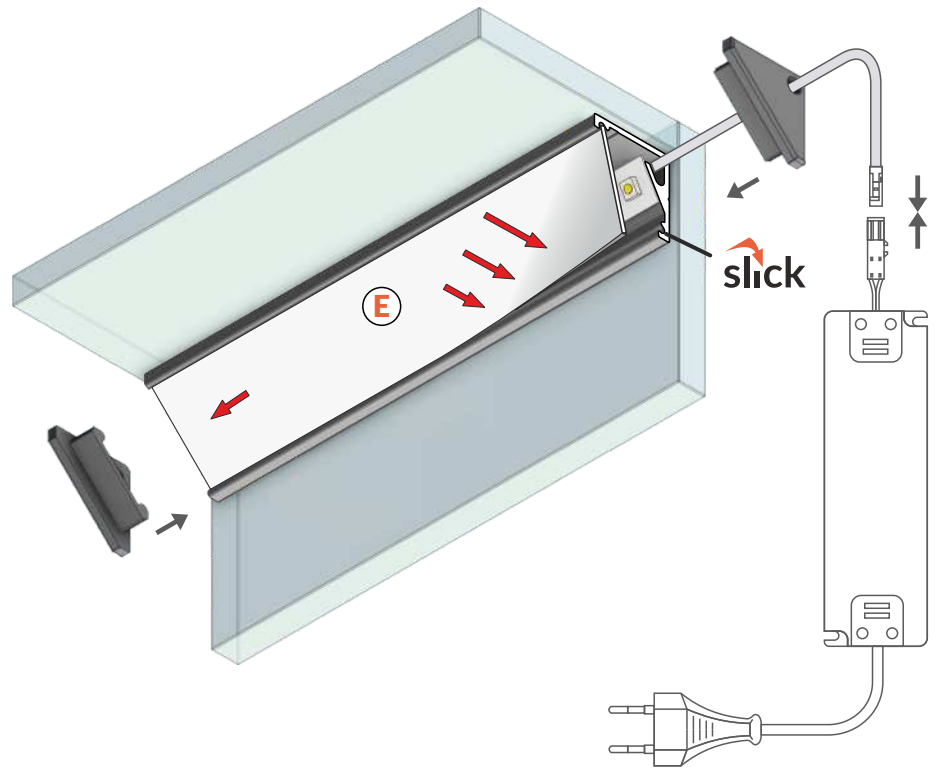

 max 12 mm

 Eckprofile
 corner



Artikelnummer = 1 Stück,
 Länge 2.000 mm,
 Verpackung > siehe bitte Preisliste
 INDEX = 1 pc, length 2000 mm
 package > check the pricelist

weiß lackiert
 white painted
C9020001



eloxiert
 anodized
C9020020



schwarz eloxiert
 black anodized
C9020021



Rohaluminium
 raw aluminium
C9020000

Die zugänglichen Längen: 1000 mm, 2000 mm.
 Die standardmäßige Toleranz der Länge von Profilen beträgt: +20 mm.
 Mehr Informationen >> 1.08.

Available lengths: 1000 mm, 2000 mm.
 The standard profile length tolerance is +20 mm.
 More details >> 1.08.



ABDECKUNG / COVERS

Abdeckung **E** einziehbar
Farben: transparent, satiniert, opal
Material: PC, PP, PP

E slide cover
colours: transparent, frosted, opal
material: PC, PP, PP



Achtung! Die Abmessungen des Platzes für die Montage von LED Lichtquelle
Note! Dimensions of the space to install LED source

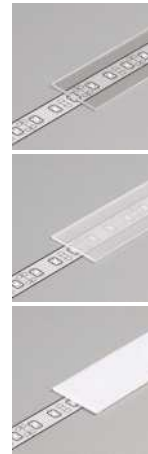
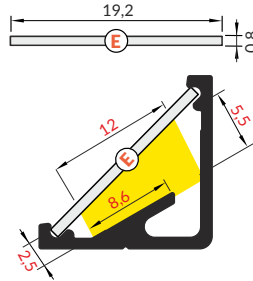

Länge 2.000 mm,
Verpackung > siehe bitte Preisliste
length 2000 mm
package > check the pricelist

E transparent
Artikelnummer = 10 Stück
index = 10 pcs
A2040016

E satiniert / E frosted
Artikelnummer = 10 Stück
index = 10 pcs
A2040039

E opal
Artikelnummer = 10 Stück
index = 10 pcs
A2040038

Die Toleranz der Länge von Abdeckungen beträgt: +20 mm.
Mehr Informationen >> 1.08.

The standard cover length tolerance is +20 mm.
More details >> 1.08.

ENDKAPPEN / ENDINGS

Endkappe CABI12
Farben: weiß, silbern, schwarz, grau
Material: ABS
CABI12 ending
colours: white, silver, black, grey
material: ABS

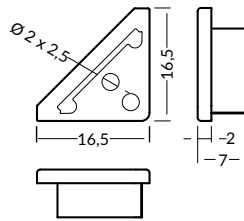

Die Endkappe mit Punkten für das Bohren von Öffnungen.
Ending with marked space to bore the holes.

Artikelnummer = 10 Sets = 20 Stück
Verpackung > siehe bitte Preisliste
INDEX = 10 sets = 20 pcs
package > check the pricelist

weiß / white
C9980001

silbern / silver
C9980040

schwarz / black
C9980002

grau / grey
C9980022

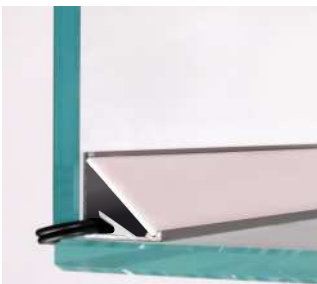

UNSICHTBARE KABEL

Ein Kabeldurchführungskanal ermöglicht das ästhetische Aussehen der Vitrine zu bewahren.

INVISIBLE WIRES

Special channel to hide the wires allows to remain esthetic look of the showcase.



GLEICHE SEITENLÄNGE

Ein symmetrischer Bau des Profils ermöglicht eine präzise Verbindung in unterschiedlichen Konfigurationen.

EQUAL SIDE LENGTHS

The symmetrical profile design allows precise connections in a different configurations.

CORNER14 EF/TY

ECKPROFIL 30°/60°

ANGULAR PROFILE 30°/60°

- dekorativ-beleuchtendes Profil
- eine versteckte Befestigung
- zwei Leuchtwinkel 30° und 60°
- maximale Breite des LED Streifens 14 mm

- decorative and lighting profile
- hidden mounting
- two lighting angles: 30°/60°
- maximum LED strip width: 14 mm



ÄHNLICHES IM ANGEBOT / SIMILAR IN THE OFFER



TRIO10
BC



CORNER10
BC/UX



QUARTER10
BD/U6



CABI12
E



CORNER27
G/UX



- E** Abdeckung E einschiebbar
E slide cover
- F** Abdeckung F einclipsbar
F click cover
- E7** Abdeckung E7 einclipsbar
E7 click cover
- Y¹** Halter Y flexibel
Y flexible mounting plate
- Y²** Halter Y flexibel cone
cone Y flexible mounting plate
- T** Halter T
T mounting plate

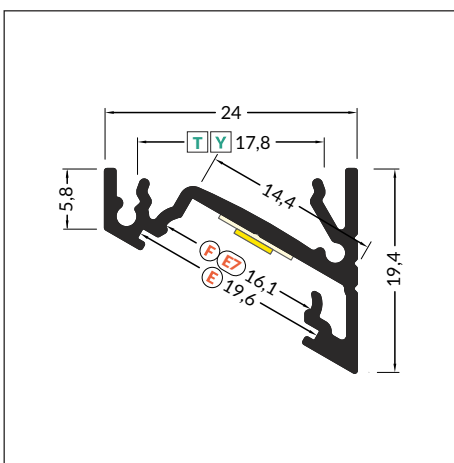
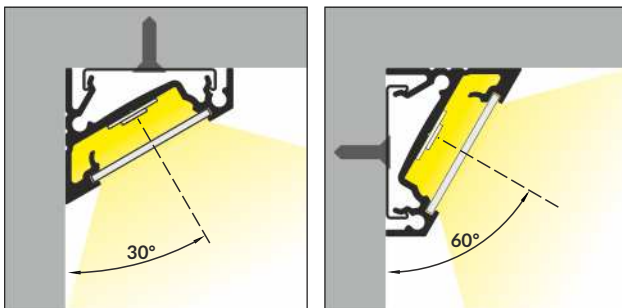
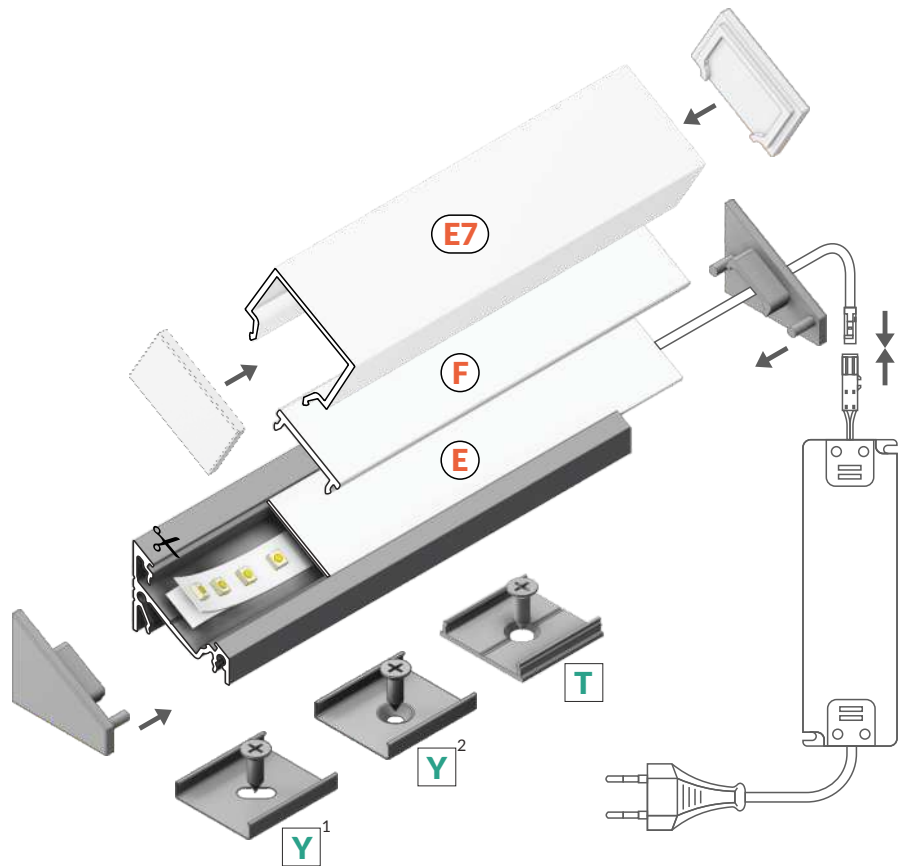

 max 14 mm

 Eckprofile
corner



Artikelnummer = 1 Stück,
Länge 2.000 mm,
Verpackung > siehe bitte Preisliste
INDEX = 1 pc, length 2000 mm
package > check the pricelist

weiß lackiert
white painted
A4020001

eloxiert
anodized
A4020020

schwarz eloxiert
black anodized
A4020021

Rohaluminium
raw aluminium
A4020000

Die zugänglichen Längen: 1000 mm, 2000 mm, 3000 mm, 4000 mm.
Die standardmäßige Toleranz der Länge von Profilen beträgt: +20 mm.
Mehr Informationen >> 1.08.

Available lengths: 1000 mm, 2000 mm, 3000 mm, 4000 mm.
The standard profile length tolerance is +20 mm.
More details >> 1.08.



ABDECKUNG / COVERS

Abdeckung E einziehbar
Farben: transparent, satiniert, opal
Material: PC, PP, PP

E slide cover
colours: transparent, frosted, opal
material: PC, PP, PP



Achtung! Die Abmessungen des Platzes für die Montage von LED Lichtquelle
Note! Dimensions of the space to install LED source

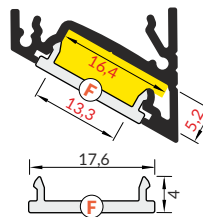
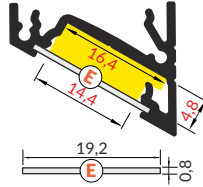

Abdeckung F einclipsbar
Farben: transparent, opal
Material: PMMA

F click cover
colours: transparent, opal
material: PMMA

Abdeckung E7 einclipsbar
Farben: opal
Material: PMMA

E7 click cover
colours: opal
material: PMMA

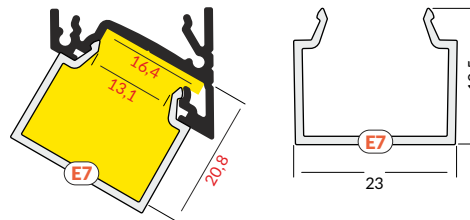

NEU

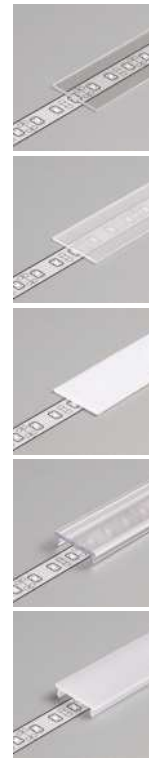

Länge 2.000 mm,
Verpackung > siehe bitte Preisliste
length 2000 mm
package > check the pricelist

E transparent
Artikelnummer = 10 Stück
index = 10 pcs
A2040016

E satiniert / E frosted
Artikelnummer = 10 Stück
index = 10 pcs
A2040039

E opal
Artikelnummer = 10 Stück
index = 10 pcs
A2040038

F transparent
Artikelnummer = 1 Stück
index = 1 pc
A2060016

F opal
Artikelnummer = 1 Stück
index = 1 pc
A2060038

Rolle, Länge 20 m,
Verpackung > siehe bitte Preisliste
reel, length 20 m
package > check the pricelist

F opal
Artikelnummer = 1 Stück
index = 1 pc
A2210038S

Länge 2.000 mm,
Verpackung > siehe bitte Preisliste
length 2000 mm
package > check the pricelist

E7 opal
Artikelnummer = 1 Stück
index = 1 pc
C1080038

Die Toleranz der Länge von Abdeckungen beträgt: +20 mm.
Mehr Informationen >> 1.08.
The standard cover length tolerance is +20 mm.
More details >> 1.08.

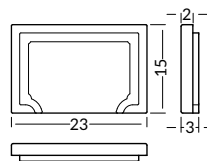

Artikelnummer = 1 Set = 2 Stück
Verpackung > siehe bitte Preisliste
INDEX = 1 set = 2 pcs
package > check the pricelist

Endkappe E7 opal
E7 opal ending
C1840038

HALTER / MOUNTINGS

Halter Y flexibel
Farben: inox
Material: rostfreier Stahl
Y flexible mounting plate
colours: inox
material: stainless steel

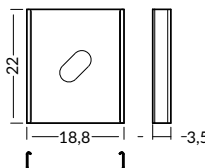
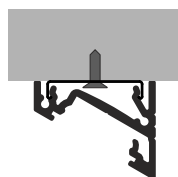

Halter Y flexibel cone
Farben: inox
Material: rostfreier Stahl
cone **Y** flexible mounting plate
colours: inox
material: stainless steel

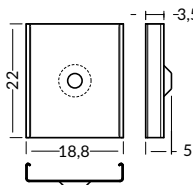
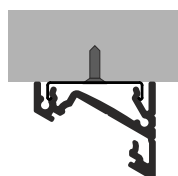

Artikelnummer = 10 Sets = 20 Stück
Verpackung > siehe bitte Preisliste
INDEX = 10 sets = 20 pcs
package > check the pricelist

inox
A2090019

inox
A2130019



HALTER / MOUNTINGS

Halter T
Farben: Rohaluminium
Material: Aluminium

T mounting plate
colours: raw aluminium
material: aluminium

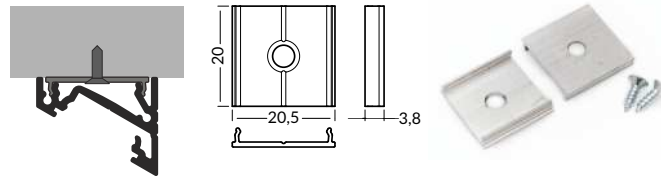

Artikelnummer = 10 Sets = 20 Stück
Verpackung > siehe bitte Preisliste
INDEX = 10 sets = 20 pcs
package > check the pricelist

Rohaluminium
raw aluminium
C6960000

ENDKAPPEN / ENDINGS

Endkappe CORNER14 gen2
Farben: weiß, silbern, schwarz, grau
Material: ABS
endings CORNER14 gen2
colours: white, silver, black, grey
material: ABS

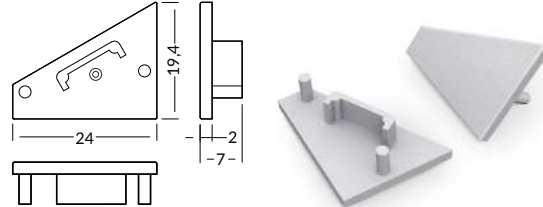

Artikelnummer = 10 Sets = 20 Stück
Verpackung > siehe bitte Preisliste
INDEX = 10 sets = 20 pcs
package > check the pricelist

weiß / white
A4980001
silbern / silver
A4980040
schwarz / black
A4980002
grau / grey
A4980022

Endkappe CORNER14 gen2 mit Öffnung
Farben: weiß, silbern, schwarz, grau
Material: ABS
endings CORNER14 gen2 with hole
colours: white, silver, black, grey
material: ABS

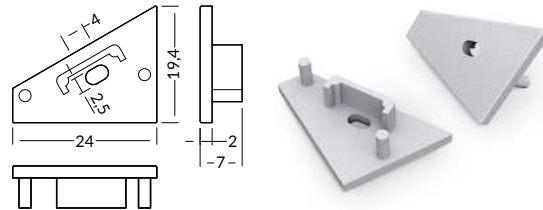

weiß / white
A4970001
silbern / silver
A4970040
schwarz / black
A4970002
grau / grey
A4970022

VERBINDUNGSSTÜCKE / CONNECTORS

Verbindungsstück T 180 Grad
Farben: Rohaluminium
Material: Aluminium
T connector 180 deg
colour: raw aluminium
material: aluminium

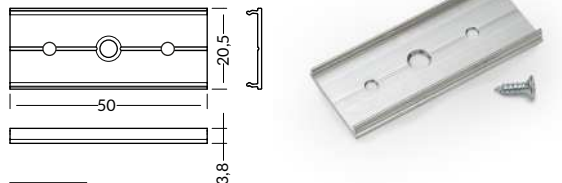

Artikelnummer = 1 Set
Verpackung > siehe bitte Preisliste
INDEX = 1 set
package > check the pricelist

Rohaluminium
raw aluminium
C6990000

Verbinder 90 Grad für CORNER14
Farben: weiß, eloxiert, schwarz
Material: Aluminium
CORNER14 connector 90 deg
colours: white, anodized, black
material: aluminium

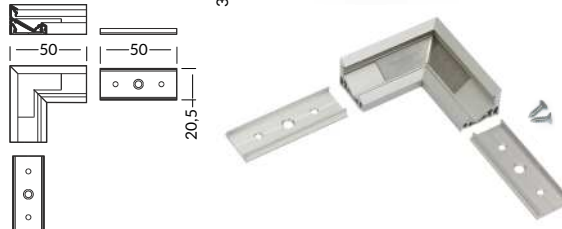

weiß lackiert
white painted
A4990001
eloxiert
anodized
A4990020

schwarz eloxiert
black anodized
A4990021



CORNER27 G/UX

EIN GROßES ECKPROFIL

LARGE-SIZE ANGULAR PROFILE

- Beleuchtungsprofil - Möglichkeit eine hohe Effizienz zu erreichen
- eine versteckte Befestigung
- zwei Leuchtwinkel 30° und 60°
- maximale Breite des LED Streifens: 27 mm oder bis drei Standardstreifen mit 8 mm Breite
- lighting profile - possibility of high lumen output
- hidden mounting
- two lighting angles: 30° or 60°
- maximum LED strip width: 27 mm or 3 standard strips (8 mm)

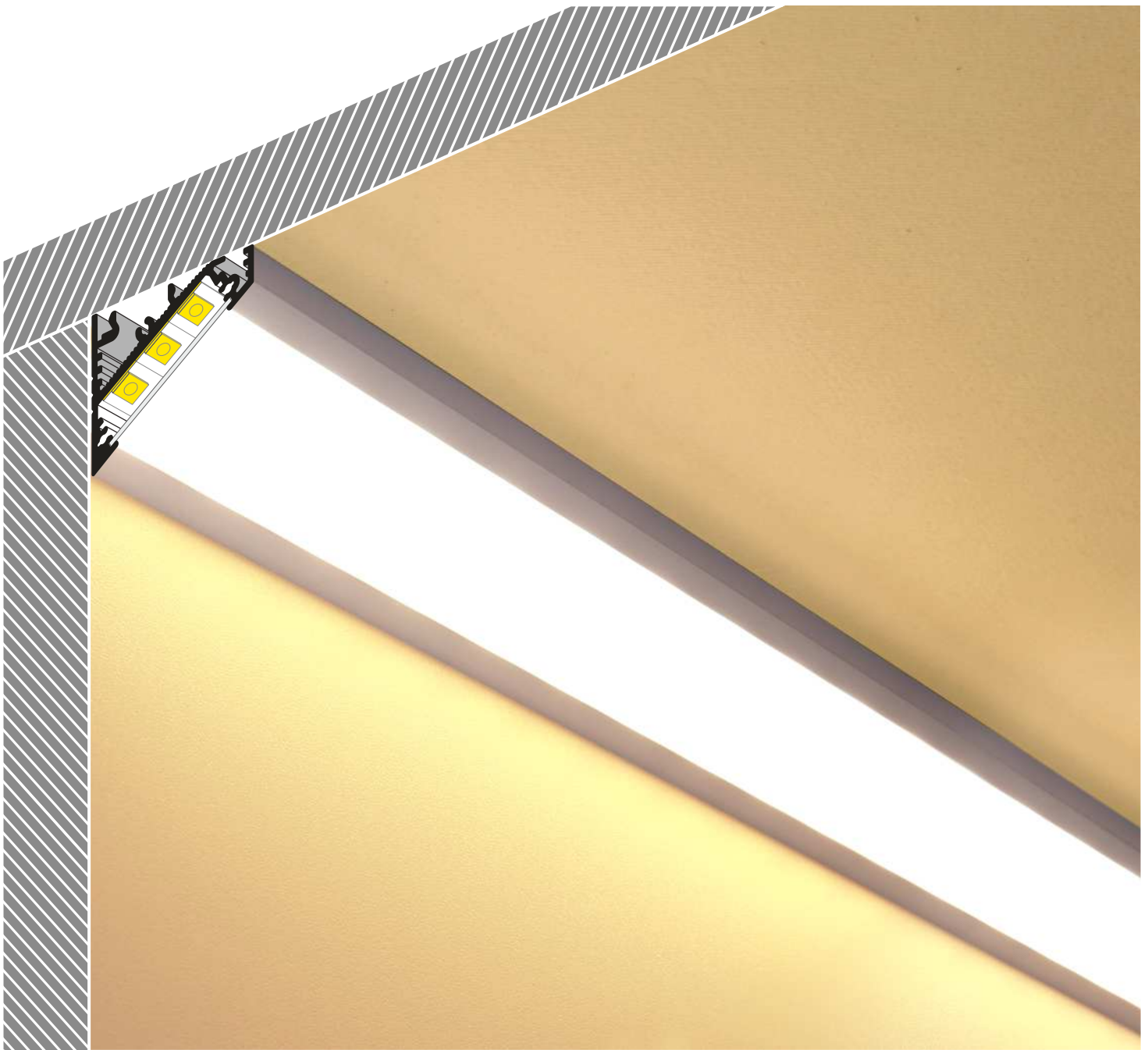

ÄHNLICHES IM ANGEBOT / SIMILAR IN THE OFFER



TRIO10
BC



CORNER10
BC/UX



QUARTER10
BD/U6



CABI12
E



CORNER14
EF/TY



G Abdeckung **G** einschiebbar
G slide cover

U¹ Halter **U** flexibel
U flexible mounting plate

U² Halter **U** flexibel cone
cone **U** flexible mounting plate

X¹ Halter **X**
X mounting plate

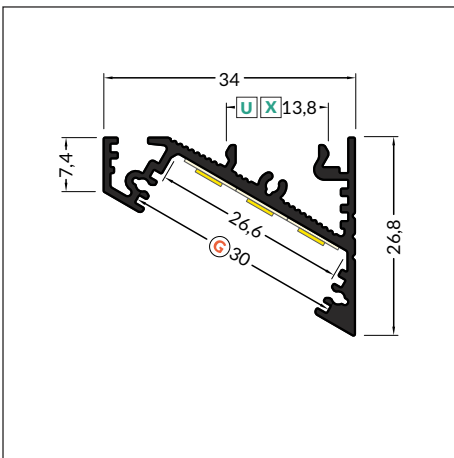
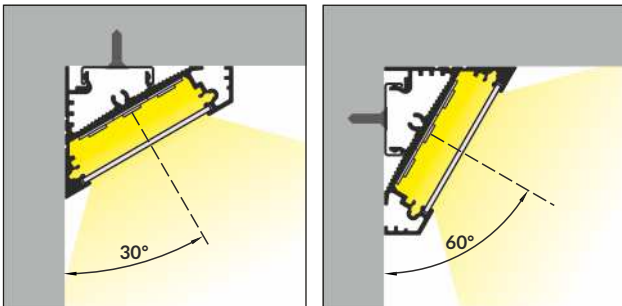
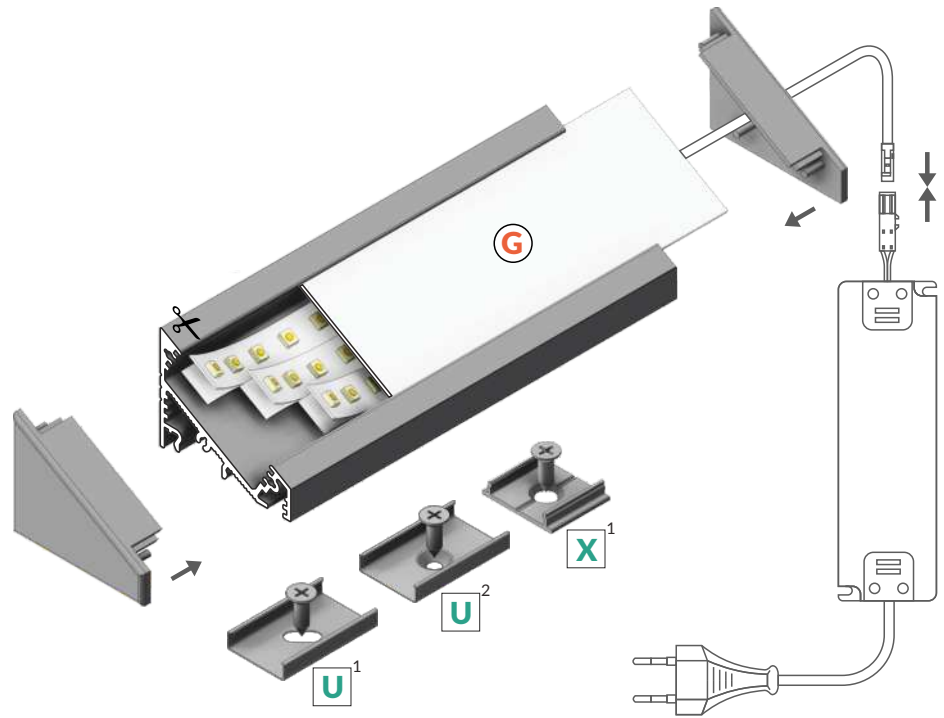

 max 27 mm

 Eckprofile
corner



Artikelnummer = 1 Stück,
Länge 2.000 mm,
Verpackung > siehe bitte Preisliste
INDEX = 1 pc, length 2000 mm
package > check the pricelist

weiß lackiert
white painted
98030001



eloxiert
anodized
98030020



schwarz eloxiert
black anodized
98030021

Die zugänglichen Längen: 1000 mm, 2000 mm, 3000 mm, 4000 mm.
Die standardmäßige Toleranz der Länge von Profilen beträgt: +20 mm.
Mehr Informationen >> 1.08.

Available lengths: 1000 mm, 2000 mm, 3000 mm, 4000 mm.
The standard profile length tolerance is +20 mm.
More details >> 1.08.



ABDECKUNG / COVERS

Abdeckung **G** einschiebbar
Farben: transparent, satiniert, opal
Material: PC, PP, PP

G slide cover
colours: transparent, frosted, opal
material: PC, PP, PP



Achtung! Die Abmessungen des Platzes für die Montage von LED Lichtquelle
Note! Dimensions of the space to install LED source

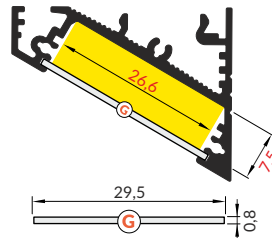

Länge 2.000 mm,
Verpackung > siehe bitte Preisliste
length 2000 mm
package > check the pricelist

G transparent
Artikelnummer = 10 Stück
index = 10 pcs
84070016

G satiniert / G frosted
Artikelnummer = 10 Stück
index = 10 pcs
84070039

G opal
Artikelnummer = 10 Stück
index = 10 pcs
84070038

Die Toleranz der Länge von Abdeckungen beträgt: +20 mm.
Mehr Informationen >> 1.08.

The standard cover length tolerance is +20 mm.
More details >> 1.08.

ENDKAPPEN / ENDINGS

Endkappe **CORNER27**
Farben: weiß, silbern, schwarz, grau
Material: ABS

endings **CORNER27**
colours: white, silver, black, grey
material: ABS

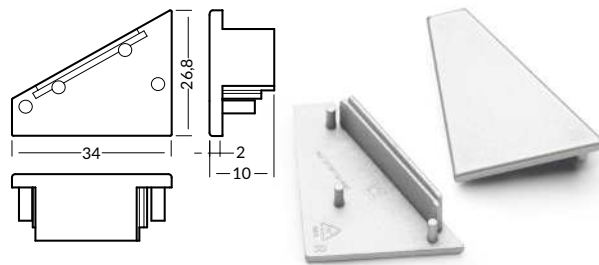

Artikelnummer = 10 Sets = 20 Stück
Verpackung > siehe bitte Preisliste
INDEX = 10 sets = 20 pcs
package > check the pricelist

weiß / white
98050001

silbern / silver
98050040

schwarz / black
98050002

grau / grey
98050022

HALTER / MOUNTINGS

Halter **U** flexibel
Farben: inox
Material: rostfreier Stahl

U flexible mounting plate
colours: inox
material: stainless steel

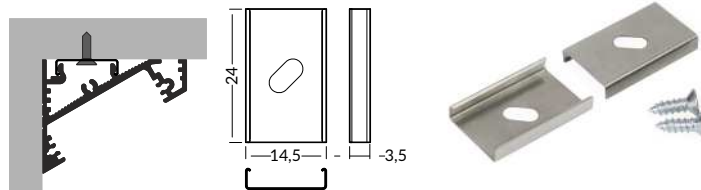

Artikelnummer = 10 Sets = 20 Stück
Verpackung > siehe bitte Preisliste
INDEX = 10 sets = 20 pcs
package > check the pricelist

inox
76380000

Halter **U** flexibel cone
Farben: inox
Material: rostfreier Stahl

cone **U** flexible mounting plate
colours: inox
material: stainless steel

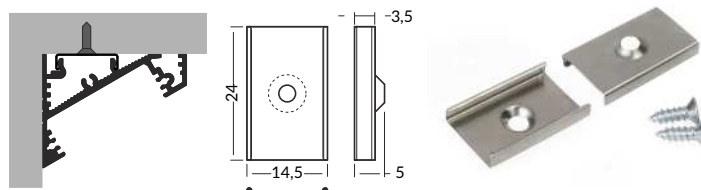

inox
76620000

Halter **X**
Farben: Rohaluminium
Material: Aluminium

X mounting plate
colours: raw aluminium
material: aluminium

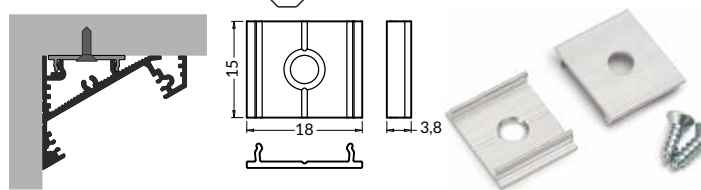

Rohaluminium
raw aluminium
76260000



VERBINDUNGSTÜCKE / CONNECTORS

Verbindungsstück X 180 Grad
Farben: Rohaluminium
Material: Aluminium

X connector 180 deg
colour: raw aluminium
material: aluminium

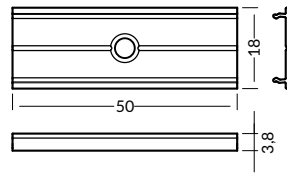

Artikelnummer = 1 Set
Verpackung > siehe bitte Preisliste
INDEX = 1 set
package > check the pricelist

Rohaluminium
raw aluminium
76350000





2020

LED PROFILE
LED PROFILES

SPEZIELLE PROFILE / SPECIAL APPLICATION



PEN8 |

EIN UNIVERSELLES ALUMINIUMPROFIL

MULTI-PURPOSE ALUMINIUM PROFILE

- ein dekorativ-beleuchtendes Profil, z.B. für die Glasvitrinen
- neun Befestigungsmöglichkeiten: für die vertikale oder horizontale Beleuchtung (auch mit Regulation)
- die Möglichkeit der Montage zwischen den Wänden
- maximale Breite des LED Streifens 8 mm

- decorative and lighting profile, eg. for glass cabinets
- 9 types of mountings: for horizontal or vertical lighting (also with adjustment)
- possibility of mounting between the walls of a cabinet
- maximum LED strip width: 8 mm

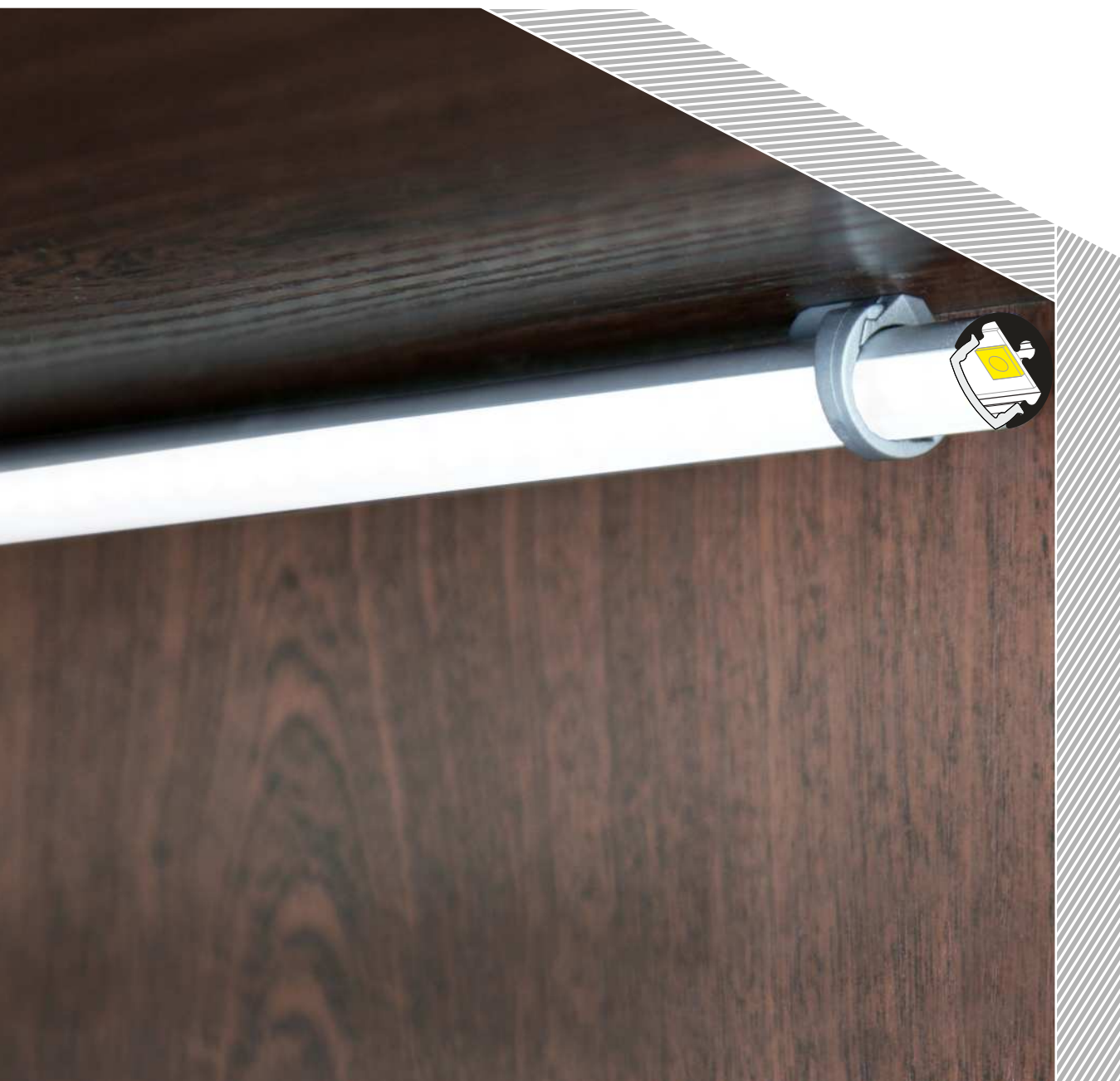

ÄHNLICHES IM ANGEBOT / SIMILAR IN THE OFFER



PEN12
CJ



CABI12
E



CORNER10
BC/UX



TRIO10
BC



OVAL20
BC



Abdeckung | einclipsbar
| click cover

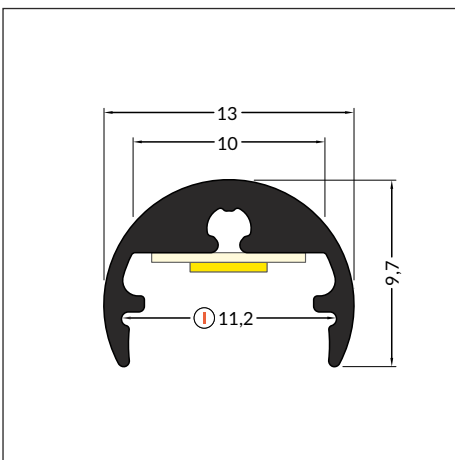
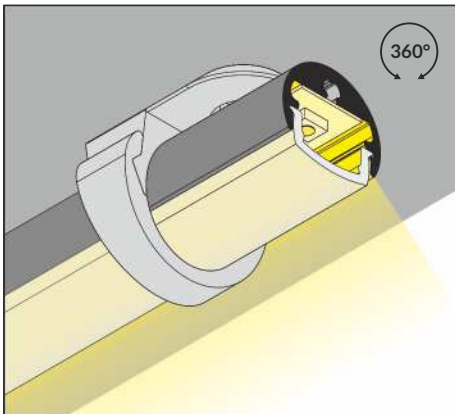
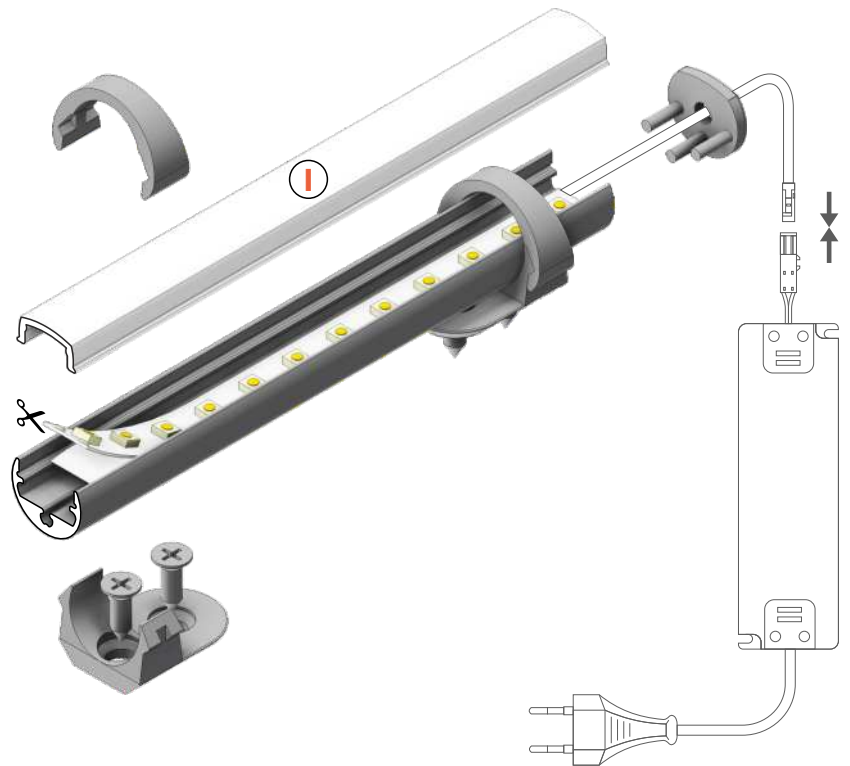

max 8 mm



spezielle Profile
special application

Artikelnummer = 1 Stück,
Länge 2.000 mm,
Verpackung > siehe bitte Preisliste
INDEX = 1 pc, length 2000 mm
package > check the pricelist

eloxiert
anodized
86030020

Die zugänglichen Längen: 1000 mm, 2000 mm, 3000 mm, 4000 mm.
Die standardmäßige Toleranz der Länge von Profilen beträgt: +20 mm.
Mehr Informationen >> 1.08.

Available lengths: 1000 mm, 2000 mm, 3000 mm, 4000 mm.
The standard profile length tolerance is +20 mm.
More details >> 1.08.



ABDECKUNG / COVERS

Abdeckung | einclipbar
Farben: satiniert, opal
Material: PMMA

| click cover
colours: frosted, opal
material: PMMA



Achtung! Die Abmessungen des Platzes für die Montage von LED Lichtquelle

Note! Dimensions of the space to install LED source

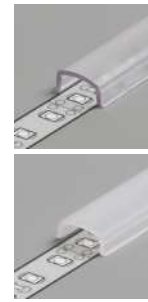
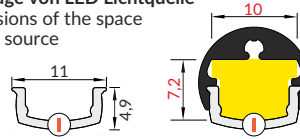

Länge 2.000 mm,
Verpackung > siehe bitte Preisliste
length 2000 mm
package > check the pricelist

| satiniert / | frosted
Artikelnummer = 1 Stück
index = 1 pc
86060000

| opal
Artikelnummer = 1 Stück
index = 1 pc
86060038

Die Toleranz der Länge von Abdeckungen beträgt: +20 mm.
Mehr Informationen >> 1.08.

The standard cover length tolerance is +20 mm.
More details >> 1.08.

ENDKAPPEN / ENDINGS

Endkappe PEN8
Farben: silbern, grau
Material: ABS

PEN8 ending
colours: silver, grey
material: ABS

Endkappe PEN8 mit Öffnung
Farben: silbern, grau
Material: ABS

PEN8 ending with hole
colours: silver, grey
material: ABS

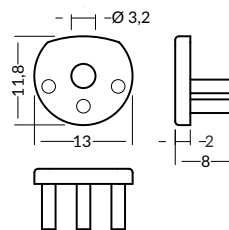

Artikelnummer = 1 Set,
Verpackung > siehe bitte Preisliste
INDEX = 1 set
package > check the pricelist

silbern / silver
86490040
grau / grey
86490022

silbern / silver
86470040
grau / grey
86470022

HALTER / MOUNTINGS

Halter PEN8 flach
Farben: grau
Material: ABS

PEN8 flat holder
colour: grey
material: ABS

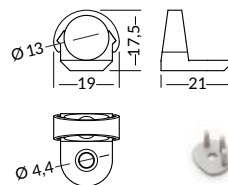
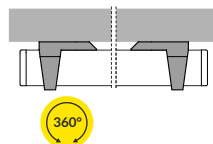

Artikelnummer = 10 Sets = 20 Stück
Verpackung > siehe bitte Preisliste
INDEX = 10 sets = 20 pcs
package > check the pricelist

grau / grey
86070022

Halter PEN8 einfach
Material: verzinkter Stahl

PEN8 simple holder
material: zinc coated steel

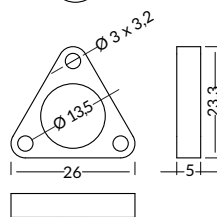
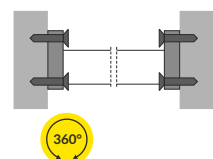

Artikelnummer = 1 Set = 2 Stück
Verpackung > siehe bitte Preisliste
INDEX = 1 set = 2 pcs
package > check the pricelist

verzinkt
zinc coated
86370030

Montagering PEN8
Farben: Chrom
Material: Messing

PEN8 ring holder
colours: chrome
material: brass

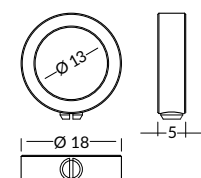
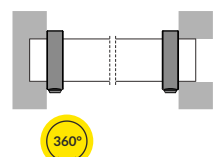

Chrom
chrome
86440003

Dübelhalter PEN8
Farben: Chrom
Material: Messing

PEN8 stretcher holder
colour: chrome
material: brass

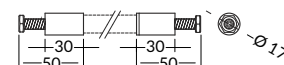
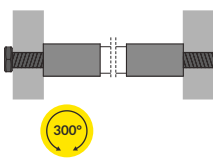

Chrom
chrome
86290003

Endhalter PEN8
Farben: Chrom
Material: Messing

PEN8 end holder
colour: chrome
material: brass

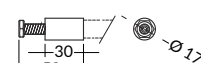
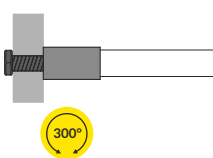

Artikelnummer = 1 Set = 1 Stück
Verpackung > siehe bitte Preisliste
INDEX = 1 set = 1 pc
package > check the pricelist

Chrom
chrome
86160003



HALTER / MOUNTINGS

Gelenkhalter mit Deckenhalter für PEN8

Farben: Chrom
Material: Stahl, Messing

PEN8 jointed holder with soffit ceiling
colour: chrome
material: steel, brass

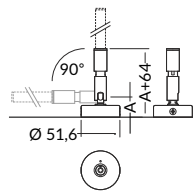

Artikelnummer = 1 Set = 1 Stück
Verpackung > siehe bitte Preisliste
INDEX = 1 set = 1 pc
package > check the pricelist

A =

27 mm	86080003
100 mm	86300003
200 mm	86100003
300 mm	86120003

Doppelhalter mit Gewinde für PEN8

Farben: Chrom
Material: Stahl, Messing

PEN8 double holder with thread
colour: chrome
material: steel, brass

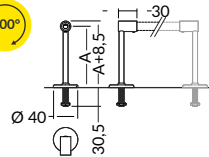

Artikelnummer = 1 Set = 2 Stück
Verpackung > siehe bitte Preisliste
INDEX = 1 set = 2 pcs
package > check the pricelist

A =

100 mm	86330003
200 mm	86180003
300 mm	86200003

Doppelhalter mit Deckenhalter für PEN8

Farben: Chrom
Material: Stahl, Messing

PEN8 double holder with soffit ceiling
colour: chrome
material: steel, brass

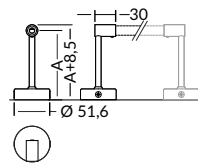

Artikelnummer = 1 Set = 2 Stück
Verpackung > siehe bitte Preisliste
INDEX = 1 set = 2 pcs
package > check the pricelist

A =

100 mm	86320003
200 mm	86170003
300 mm	86190003

Photo: / Photo:
PORSÄ - Systemy Meblowe Mirosław Krysiak



BACK10 A/UX

ZWEI ABSTRAHLRICHTUNGEN

TWO LIGHTING DIRECTIONS

- dekorative Beleuchtung
 - Konstruktion in der Form des Buchstabens "T" ermöglicht das Lichtstrom in zwei Richtungen zu richten (oben/unten, rechts/links)
 - Befestigung mit Hilfe von speziellen Haltern (an die Wand) oder direkt mit Hilfe der Schrauben (an ein Möbelstück)
 - eine optionale Anwendung der Abdeckung A
 - maximale Breite des LED Streifens 10 mm
-
- decorative illumination
 - the T-shaped structure makes possible to direct the light beam in two directions (up/down, left/right)
 - mounting with two dedicated holders (to the wall) or directly to the piece of furniture, using screws
 - optionally, the A cover can be used
 - maximum LED strip width: 10 mm

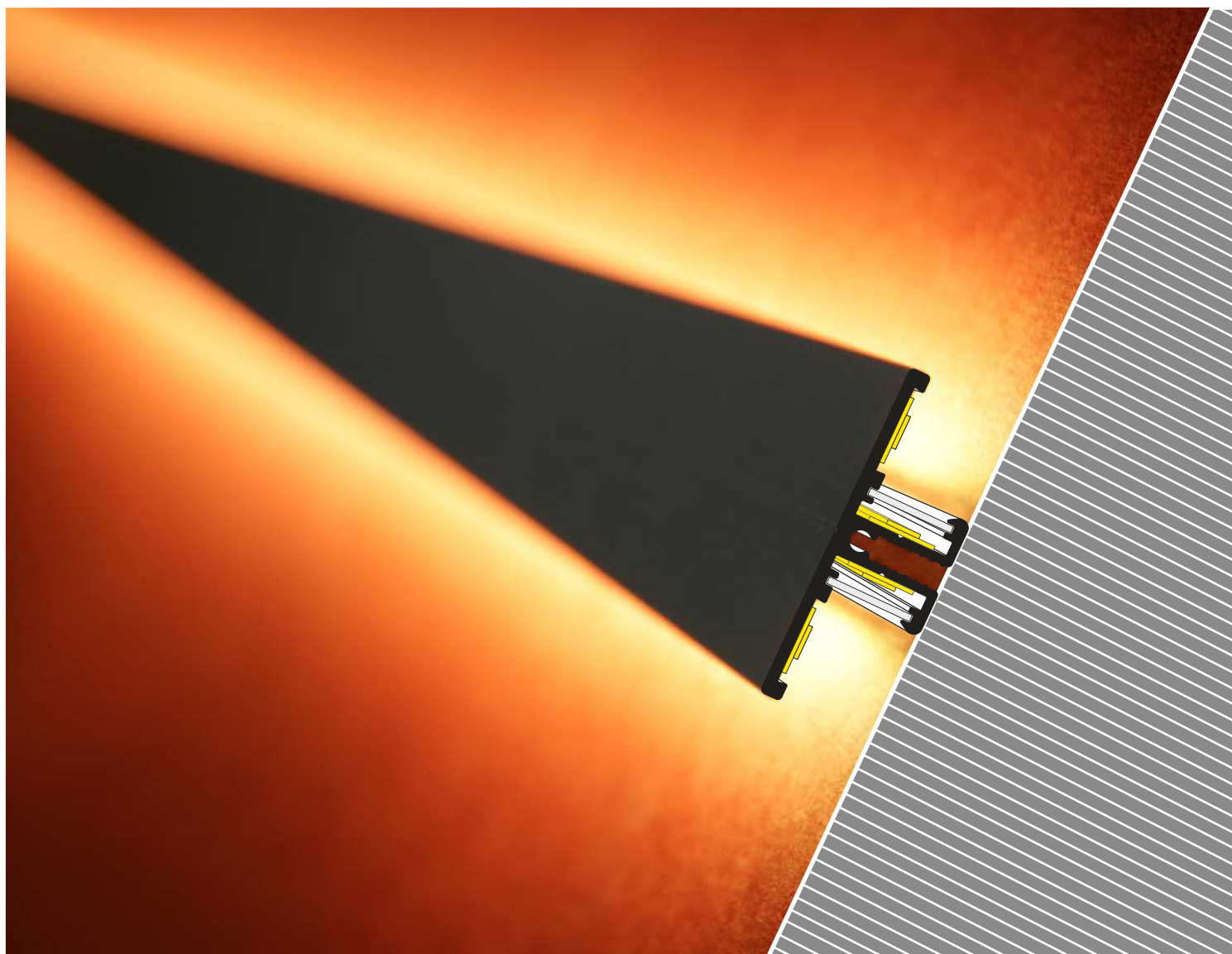

ÄHNLICHES IM ANGEBOT / SIMILAR IN THE OFFER



TWIN8



WALLE12
CD



A Abdeckung **A** einschiebbar
A slide cover

U¹ Halter **U** flexibel
U flexible mounting plate

U² Halter **U** flexibel cone
cone U flexible mounting plate

X¹ Halter **X**
X mounting plate

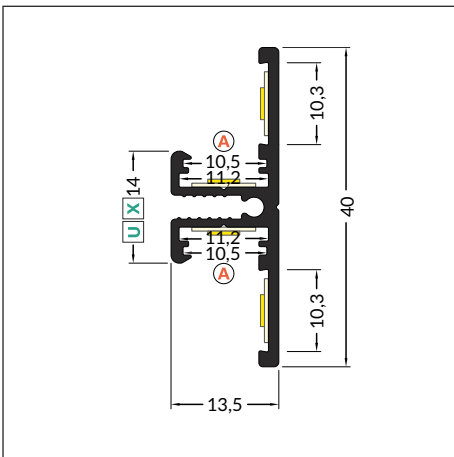
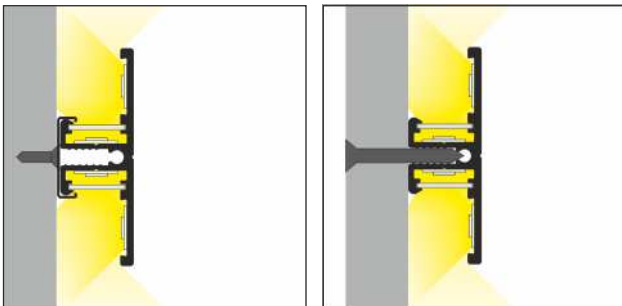
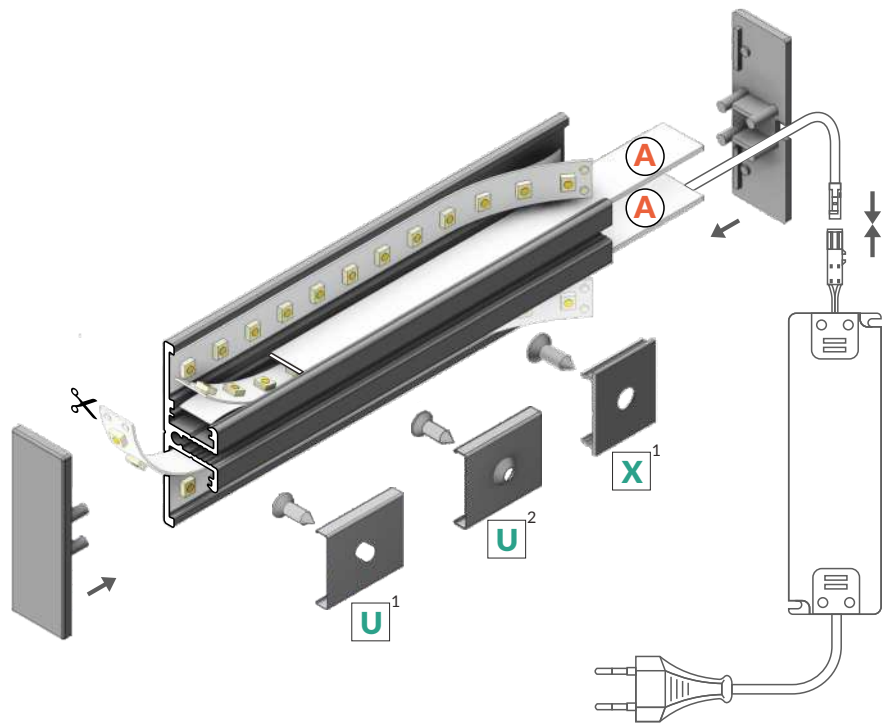

max 10 mm

spezielle Profile
special application



Artikelnummer = 1 Stück,
Länge 2.000 mm,
Verpackung > siehe bitte Preisliste
INDEX = 1 pc. length 2000 mm
package > check the pricelist

weiß lackiert
white painted
90030001

eloxiert
anodized
90030020

schwarz lackiert
black painted
90030002

Rohaluminium
raw aluminium
90030000

Die zugänglichen Längen: 1000 mm, 2000 mm, 3000 mm, 4000 mm.
Die standardmäßige Toleranz der Länge von Profilen beträgt: +20 mm.
Mehr Informationen >> 1.08.

Available lengths: 1000 mm, 2000 mm, 3000 mm, 4000 mm.
The standard profile length tolerance is +20 mm.
More details >> 1.08.



ABDECKUNG / COVERS

Abdeckung **A** einziehbar
Farben: transparent, satiniert, opal
Material: PC, PP, PP

A slide cover
colours: transparent, frosted, opal
material: PC, PP, PP

Achtung! Die Abmessungen des Platzes für die Montage von LED Lichtquelle
Note! Dimensions of the space to install LED source

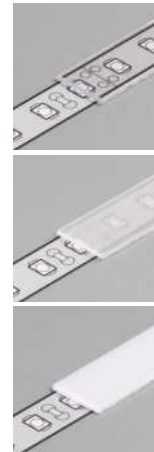
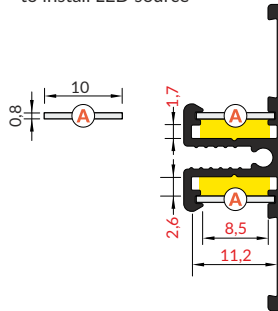

Länge 2.000 mm,
Verpackung > siehe bitte Preisliste
length 2000 mm
package > check the pricelist

A transparent
Artikelnummer = 10 Stück
index = 10 pcs
89070016

A satiniert / A frosted
Artikelnummer = 10 Stück
index = 10 pcs
89070039

A opal
Artikelnummer = 10 Stück
index = 10 pcs
89070038

Die Toleranz der Länge von Abdeckungen beträgt: +20 mm.
Mehr Informationen >> 1.08.

The standard cover length tolerance is +20 mm.
More details >> 1.08.

ENDKAPPEN / ENDINGS

Endkappe **BACK10**
Farben: weiß, silbern, schwarz, grau
Material: ABS

BACK10 ending
colours: white, silver, black, grey
material: ABS

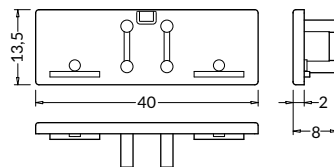

Artikelnummer = 10 Sets = 20 Stück
Verpackung > siehe bitte Preisliste
INDEX = 10 sets = 20 pcs
package > check the pricelist

weiß / white
90100001
silbern / silver
90100040
schwarz / black
90100002
grau / grey
90100022

Endkappe **BACK10 mit Öffnung**
Farben: weiß, silbern, schwarz, grau
Material: ABS

BACK10 ending with hole
colours: white, silver, black, grey
material: ABS

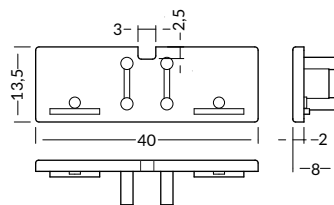

weiß / white
90150001
silbern / silver
90150040
schwarz / black
90150002
grau / grey
90150022

HALTER / MOUNTINGS

Halter **U** flexibel
Farben: inox
Material: rostfreier Stahl

U flexible mounting plate
colour: inox
material: stainless steel

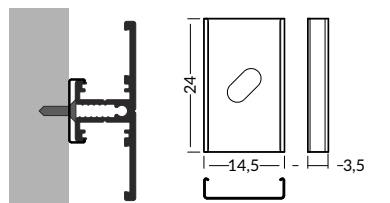

Artikelnummer = 10 Sets = 20 Stück
Verpackung > siehe bitte Preisliste
INDEX = 10 sets = 20 pcs
package > check the pricelist

inox
76380000

Halter **U** flexibel cone
Farben: inox
Material: rostfreier Stahl

cone **U** flexible mounting plate
colour: inox
material: stainless steel

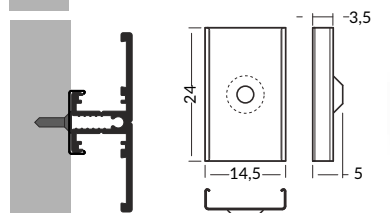

inox
76620000

Halter **X**
Farben: Rohaluminium
Material: Aluminium

X mounting plate
colour: raw aluminium
material: aluminium

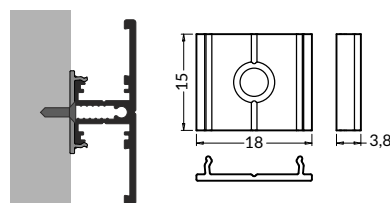

Rohaluminium
raw aluminium
76260000



VERBINDUNGSTÜCKE / CONNECTORS

Verbindungsstück X 180 Grad
Farben: inox
Material: Aluminium

X connector 180 deg
colour: raw aluminium
material: aluminium

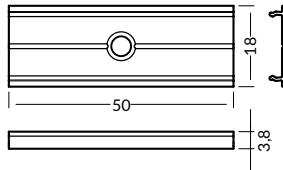

Artikelnummer = 1 Set,
Verpackung > siehe bitte Preisliste
INDEX = 1 set
package > check the pricelist

Rohaluminium
raw aluminium
76350000



STEP10 C

TREPPENPROFIL

STEP EDGE PROFILE

- betonender oder beleuchtender Leuchten Effekt
 - zwei Montagemöglichkeiten - drei Leuchtvarianten zur Wahl
 - die Möglichkeit der Montage von einem Anti-Rutsch-Streifen
 - eine versteckte Befestigung
 - schlagbeständig
 - maximale Breite des LED Streifens 10 mm
-
- highlighting or illuminating feature
 - 2 mounting options - 3 lighting options to choose from
 - anti slip insert installation option
 - hidden mounting
 - impact resistant
 - maximum LED strip width: 10 mm

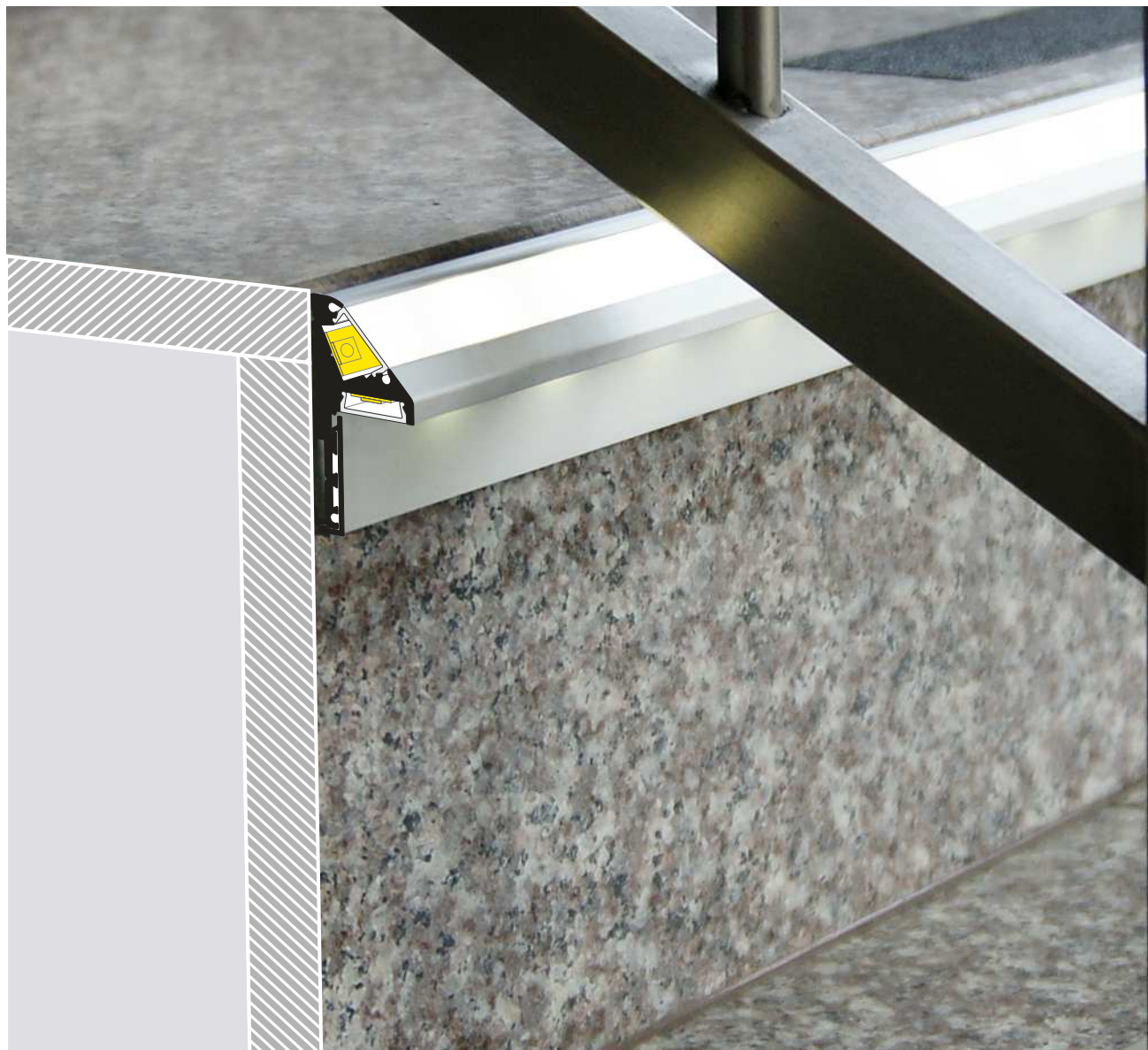

ÄHNLICHES IM ANGEBOT / SIMILAR IN THE OFFER



C Abdeckung **C** einclipsbar
C click cover

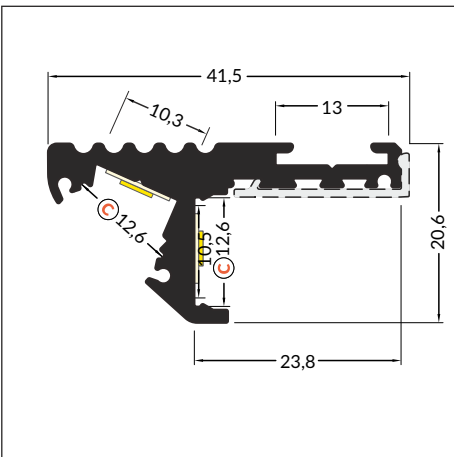
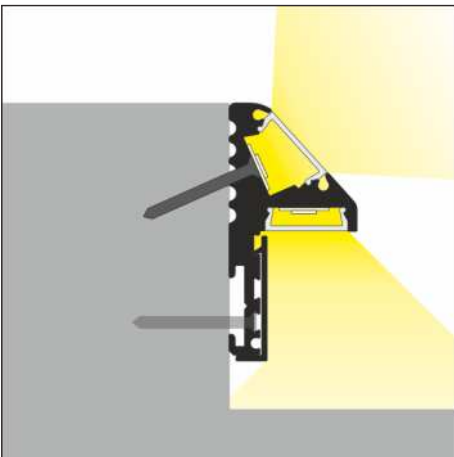
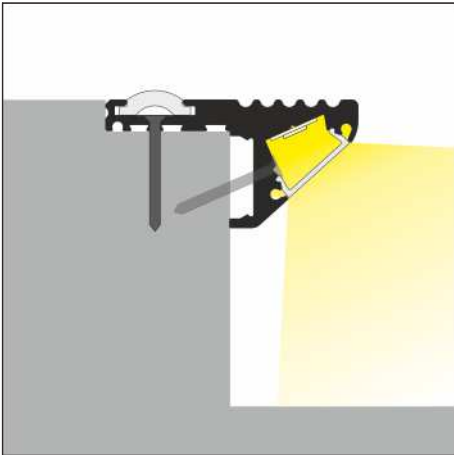

max 10 mm



spezielle Profile
 special application

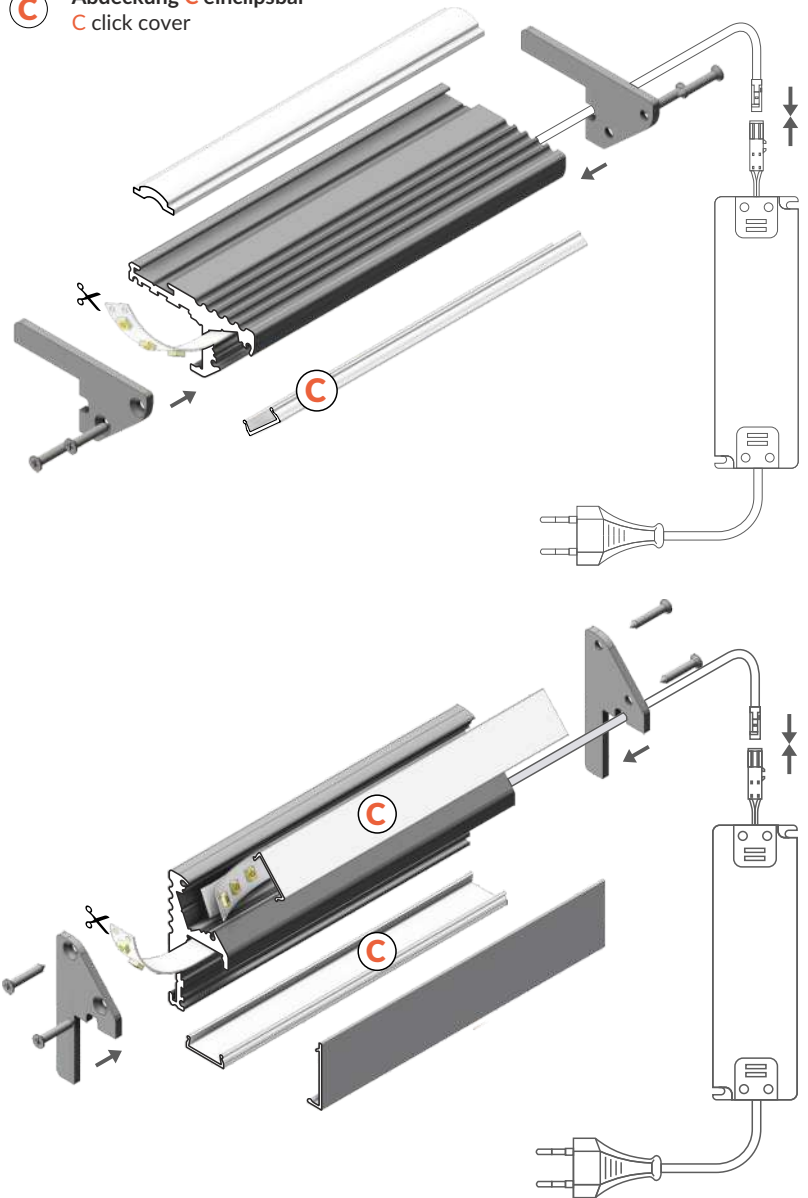

Artikelnummer = 1 Stück,
 Länge 2.000 mm.
 Verpackung > siehe bitte Preisliste
 INDEX = 1 pc, length 2000 mm
 package > check the pricelist

eloxiert
 anodized
32080020



schwarz eloxiert
 black anodized
32080021

Die zugänglichen Längen: 1000 mm, 2000 mm, 3000 mm, 4000 mm.
 Die standardmäßige Toleranz der Länge von Profilen beträgt: +20 mm.
 Mehr Informationen >> 1.08.

Available lengths: 1000 mm, 2000 mm, 3000 mm, 4000 mm.
 The standard profile length tolerance is +20 mm.
 More details >> 1.08.



ABDECKUNG / COVERS

Abdeckung **C** einclipsbar
Farben: transparent, opal
Material: PMMA

C click cover
colours: transparent, opal
material: PMMA



Achtung! Die Abmessungen des Platzes für die Montage von LED Lichtquelle
Note! Dimensions of the space to install LED source

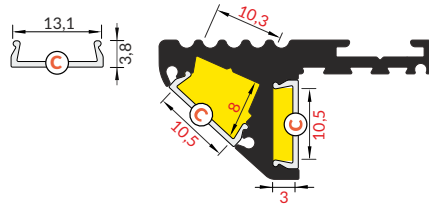

Länge 2.000 mm,
Verpackung > siehe bitte Preisliste
length 2000 mm
package > check the pricelist

C transparent

Artikelnummer = 1 Stück
index = 1 pc

76330000

C opal

Artikelnummer = 1 Stück
index = 1 pc

76330038



Rolle, Länge 20 m,
Verpackung > siehe bitte Preisliste
reel, length 20 m
package > check the pricelist

C opal

Artikelnummer = 1 Stück
index = 1 pc

76360038S

NEU

Die Toleranz der Länge von Abdeckungen beträgt: +20 mm.
Mehr Informationen >> 1.08.

The standard cover length tolerance is +20 mm.
More details >> 1.08.

ENDKAPPEN / ENDINGS

Endkappe STEP10
Farben: silbern, schwarz
Material: Stahl
STEP10 ending
colours: silver, black
material: steel

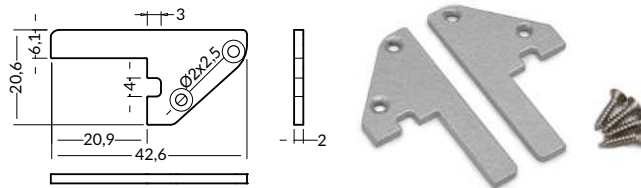

Artikelnummer = 1 Set = 2 Stück
Verpackung > siehe bitte Preisliste
INDEX = 1 set = 2 pcs
package > check the pricelist

silbern

silver

32100022

schwarz

black

32100002

ALUMINIUMABDECKPLATTE / COVER

Aluminiumabdeckplatte für das LED Profil STEP10
Farben: eloxiert, schwarz
Material: Aluminium

STEP10 LED cover
colours: anodized, black
material: aluminium

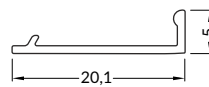

Artikelnummer = 1 Stück,
Länge 2.000 mm,
Verpackung > siehe bitte Preisliste
INDEX = 1 pc, length 2000 mm
package > check the pricelist

eloxiert
anodized
32120020

schwarz eloxiert
black anodized
32120021

Die zugänglichen Längen: 1000 mm, 2000 mm, 3000 mm, 4000 mm.
Die standardmäßige Toleranz der Länge von Profilen beträgt: +20 mm.
Mehr Informationen auf der Seite 1.08.

Available lengths: 1000 mm, 2000 mm, 3000 mm, 4000 mm.
The standard profile length tolerance is +20 mm.
For more details please see page 1.08.

ANTI-RUTSCH-STREIFEN / INSERT

Anti-Rutsch-Streifen für STEP10
Farben: transparent, schwarz

STEP10 anti slip insert
colours: transparent, black



Artikelnummer = 1 Stück,
Länge 2.000 mm,
Verpackung > siehe bitte Preisliste
INDEX = 1 pc, length 2000 mm
package > check the pricelist

transparent
transparent
32150000

schwarz
black
32150002

1. Das Beleuchten einer Treppe und die Anwendung eines Anti-Rutsch-Streifens.

1. Illuminating a step with anti slip insert applied.



2. Treppenbeleuchtung und Betonung von Treppenkanten.

2. Illuminating a step and edge highlighting.



WAY10 C

BELEUCHTUNGSLEISTE FÜR KOMMUNIKATIONSWEGE STRIP FOR ILLUMINATING PASSAGEWAYS

- zur Wandmontage bestimmt
 - verdeckte Halterung und Leitungen
 - ohne scharfe Kanten
 - maximale Breite des LED Streifens 10 mm
-
- dedicated for wall mounting
 - hidden mounting and wiring
 - curved shape
 - maximum LED strip width: 10 mm



ÄHNLICHES IM ANGEBOT / SIMILAR IN THE OFFER



WALLE12
CD



BACK10
A/UX

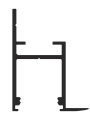

FRAME14
BC/Q



C Abdeckung **C** einclipsbar
C click cover

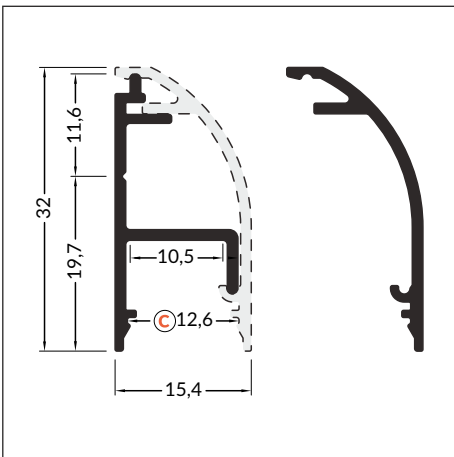
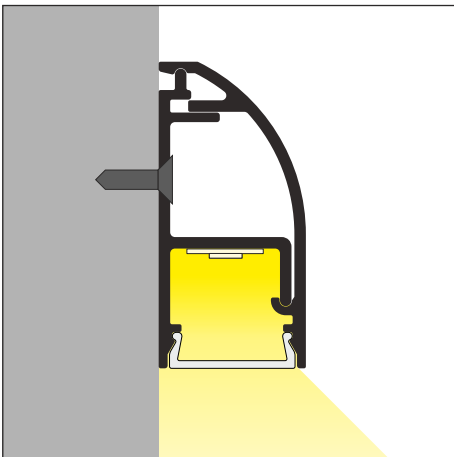
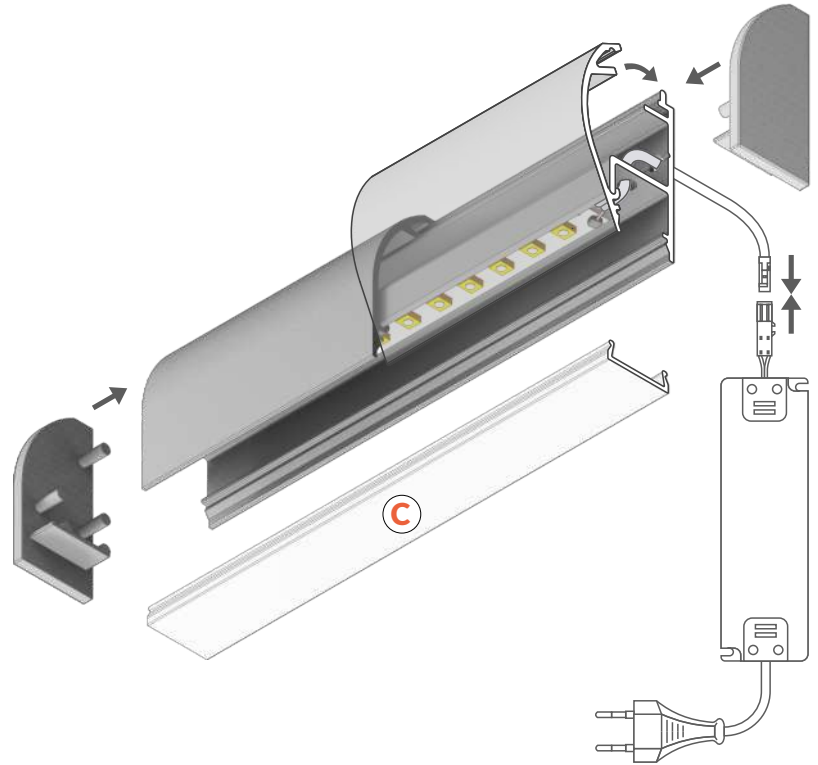

max 10 mm



spezielle Profile
special application

Artikelnummer = 1 Stück,
Länge 2.000 mm,
Verpackung > siehe bitte Preisliste
INDEX = 1 pc, length 2000 mm
package > check the pricelist



eloxiert
anodized
F9000220

Die zugänglichen Längen: 1000 mm, 2000 mm, 3000 mm, 4000 mm.
Die standardmäßige Toleranz der Länge von Profilen beträgt: +20 mm.
Mehr Informationen >> 1.08.

Available lengths: 1000 mm, 2000 mm, 3000 mm, 4000 mm.
The standard profile length tolerance is +20 mm.
More details >> 1.08.



ABDECKUNG / COVERS

Abdeckung **C** einclipsbar
Farben: transparent, opal
Material: PMMA

C click cover
colours: transparent, opal
material: PMMA



Achtung! Die Abmessungen des Platzes für die Montage von LED Lichtquelle
Note! Dimensions of the space to install LED source

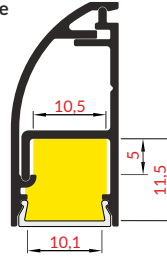
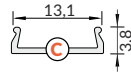

Länge 2.000 mm,
Verpackung > siehe bitte Preisliste
length 2000 mm
package > check the pricelist

C transparent
Artikelnummer = 1 Stück
index = 1 pc
76330000

C opal
Artikelnummer = 1 Stück
index = 1 pc
76330038



Rolle, Länge 20 m,
Verpackung > siehe bitte Preisliste
reel, length 20 m
package > check the pricelist

C opal
Artikelnummer = 1 Stück
index = 1 pc
76360038S

NEU

Die Toleranz der Länge von Abdeckungen beträgt: +20 mm.
Mehr Informationen >> 1.08.
The standard cover length tolerance is +20 mm.
More details >> 1.08.

ENDKAPPEN / ENDINGS

Endkappe WAY10
Farben: weiß, silbern, schwarz, grau
Material: ABS

WAY10 ending
colours: white, silver, black, grey
material: ABS

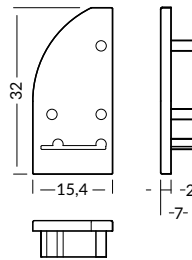

Die Endkappe mit Punkten für das Bohren von Öffnungen.
Ending with marked space to bore the holes.

Artikelnummer = 10 Sets = 20 Stück
Verpackung > siehe bitte Preisliste
INDEX = 10 sets = 20 pcs
package > check the pricelist

weiß / white
F9009901

silbern / silver
F9009940

schwarz / black
F9009902

grau / grey
F9009922

ALUMINIUMABDECKPLATTE / COVER

Aluminiumabdeckplatte für das LED Profil WAY10
Farben: weiß, eloxiert, schwarz, Rohaluminium
Material: Aluminium

WAY10 LED cover
colours: white, anodized, black, raw aluminium
material: aluminium

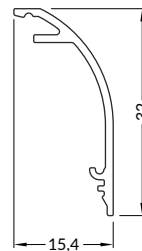

Artikelnummer = 1 Stück,
Länge 2.000 mm,
Verpackung > siehe bitte Preisliste
INDEX = 1 pc, length 2000 mm
package > check the pricelist

weiß lackiert
white painted
F9000601

eloxiert
anodized
F9000620

schwarz lackiert
black painted
F9000602

Rohaluminium
raw aluminium
F9000600

Die zugänglichen Längen: 1000 mm, 2000 mm, 3000 mm, 4000 mm. Die standardmäßige Toleranz der Länge von Profilen beträgt: +20 mm.
Mehr Informationen >> 1.08.
Available lengths: 1000 mm, 2000 mm, 3000 mm, 4000 mm.
The standard profile length tolerance is +20 mm.
More details >> 1.08.



ARC12 CD/U5

EIN BIEGBARES ALUMINIUMPROFIL

FLEXIBLE ALUMINIUM LED PROFILE

- ein Aluminiumprofil für Biegen in zwei Richtungen einer Ebene
- das Profil behält die Biegungsform
- minimaler Biegungsradius: 50 cm
- die Möglichkeit zwei Abdeckungen anzuwenden - bessere Lichtzerstreuung
- Montage im Außenbereich möglich (bei dem Anwenden einer D klick Abdeckung und eines wasserdichten LED Streifens)
- maximale Breite des LED Streifens 12 mm

- flexible aluminium profile - possibility of bending in two directions
- the profile keeps shaped bend
- minimal bending radius: 50 cm
- possibility of using two diffusers - better light dispersion
- possible outside installation (with D cover and waterproof LED strip used)
- maximum LED strip width: 12 mm



ÄHNLICHES IM ANGEBOT / SIMILAR IN THE OFFER

SLIM8
AC2/Z

SMART10
AC2/Z

BEGTON12
J/S

UNI12
BCD/U



C Abdeckung C einclipsbar
C click cover

D Abdeckung D einclipsbar
D click cover

U5¹ Halter U5
U5 mounting plate

U5² Seitenhalter U5
side U5 mounting plate

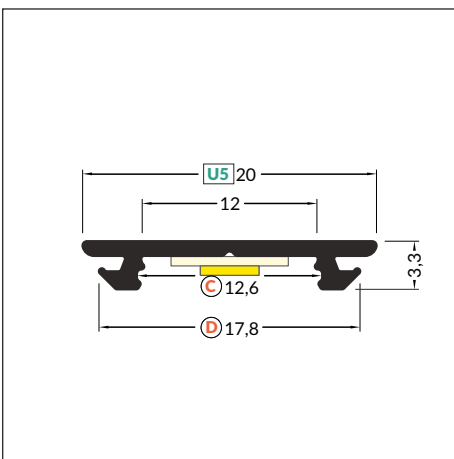
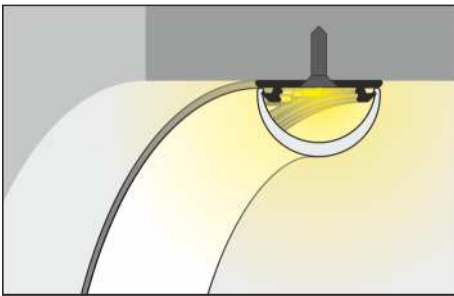
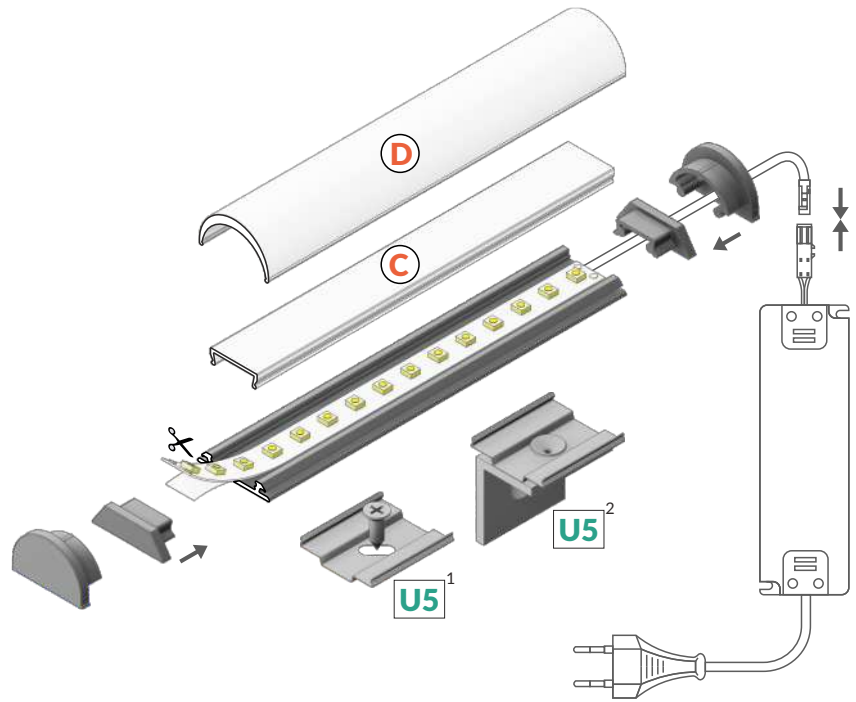

 max 12 mm

 spezielle Profile
special application



Artikelnummer = 1 Stück,
Länge 2.000 mm,
Verpackung > siehe bitte Preisliste
INDEX = 1 pc, length 2000 mm
package > check the pricelist

weiß lackiert
white painted
B2010001



eloxiert
anodized
B2010020



schwarz lackiert
black painted
B2010002



Rohaluminium
raw aluminium
B2010000

Die zugänglichen Längen: 1000 mm, 2000 mm, 3000 mm, 4000 mm.
Die standardmäßige Toleranz der Länge von Profilen beträgt: +20 mm.
Mehr Informationen >> 1.08.

Available lengths: 1000 mm, 2000 mm, 3000 mm, 4000 mm.
The standard profile length tolerance is +20 mm.
More details >> 1.08.



ABDECKUNG / COVERS

Abdeckung **C** einclipsbar
Farben: transparent, opal
Material: PMMA

C click cover
colours: transparent, opal
material: PMMA



Achtung! Die Abmessungen des Platzes für die Montage von LED Lichtquelle
Note! Dimensions of the space to install LED source

Eine maximale Breite des LED Streifens
Bei der Anwendung von der Abdeckung C 10 mm
Maximum LED strip width
while using C cover: 10 mm

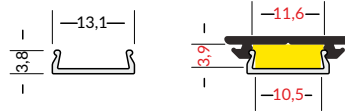

NEU



Länge 2.000 mm,
Verpackung > siehe bitte Preisliste
length 2000 mm
package > check the pricelist

C transparent
Artikelnummer = 1 Stück
index = 1 pc
76330000

C opal
Artikelnummer = 1 Stück
index = 1 pc
76330038



Rolle, Länge 20 m,
Verpackung > siehe bitte Preisliste
reel, length 20 m
package > check the pricelist

C opal
Artikelnummer = 1 Stück
index = 1 pc
76360038S



Länge 2.000 mm,
Verpackung > siehe bitte Preisliste
length 2000 mm
package > check the pricelist

D opal
Artikelnummer = 1 Stück
index = 1 pc
A1140038

Abdeckung **D** einclipsbar
Farben: opal
Material: PMMA

D click cover
colour: opal
material: PMMA

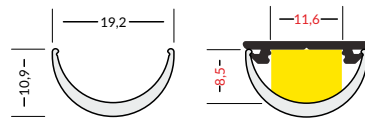

Die Toleranz der Länge von Abdeckungen beträgt: +20 mm.
Mehr Informationen >> 1.08.

The standard cover length tolerance is +20 mm.
More details >> 1.08.

ENDKAPPEN / ENDINGS

Endkappe **ARC12**
Farben: weiß, silbern, schwarz, grau
Material: ABS
ARC12 ending
colours: white, silver, black, grey
material: ABS



Die Endkappe mit Punkten für das Bohren von Öffnungen.
Ending with marked space to bore the holes.

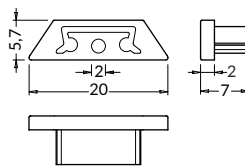

Endkappe **ARC12 D**
Farben: weiß, silbern, schwarz, grau
Material: ABS
ARC12 D ending
colours: white, silver, black, grey
material: ABS

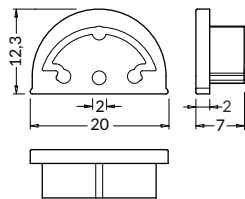

Artikelnummer = 10 Sets = 20 Stück
Verpackung > siehe bitte Preisliste
INDEX = 10 sets = 20 pcs
package > check the pricelist

weiß / white
B2960001
silbern / silver
B2960040
schwarz / black
B2960002
grau / grey
B2960022

weiß / white
B2980001
silbern / silver
B2980040
schwarz / black
B2980002
grau / grey
B2980022

HALTER / MOUNTINGS

Halter **U5** cone
Farben: inox
Material: rostfreier Stahl
cone **U5** mounting plate
colour: inox
material: stainless steel

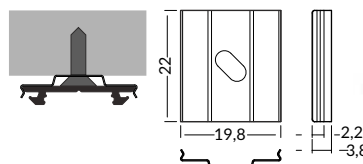

Artikelnummer = 10 Sets = 20 Stück
Verpackung > siehe bitte Preisliste
INDEX = 10 sets = 20 pcs
package > check the pricelist

inox
B2940019

Seitenhalter **U5**
Farben: weiß, silbern, schwarz
Material: rostfreier Stahl, Aluminium
side **U5** mounting plate
colours: white, silver, black
material: stainless steel, aluminium

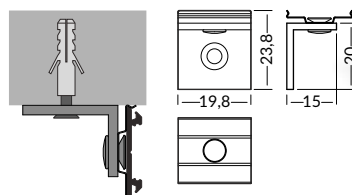

weiß / white
B2920001
silbern / silver
B2920022
schwarz / black
B2920002



ABHÄNGUNG / SLING

Abhängung SELV 50V 1500
Farben: weiß, silbern, schwarz
SELV sling 50 V 1500
colour: white, silver, black

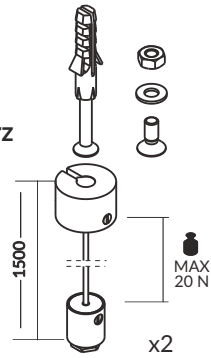

Artikelnummer = 1 Set = 2 Stück
Verpackung > siehe bitte Preisliste
INDEX = 1 set = 2 pcs
package > check the price list

weiß / white
67120001

silbern / silver
67120022

schwarz / black
67120002



FIX12 / FIX16



DIE EINFACHSTE MONTAGE DES LED STREIFENS

THE SIMPLEST INSTALLATION OF A LED STRIP

- Wärmeabfuhrfunktion
- festeres Haften der LED Lichtquelle
- die kleinste Höhe des Profils
- ein Budget-Profil für die Anwendung ohne Abdeckung
- maximale Breite des LED Streifens: 12 mm (FIX12) und 16 mm (FIX16)
- es kann auch die Montagefunktion erfüllen:
FIX12 für die Profile mit Befestigungssockel X
FIX16 für die Profile mit Befestigungssockel T

- function of radiator
- improves LED strip's adhesion
- minimal height of the profile
- budget profile, to be used without a cover
- maximum width of LED strip: 12 mm (FIX12) and 16 mm (FIX16)
- it can also function as a mounting profile:
FIX12 for profiles with X socket
FIX16 for profiles with T socket



ÄHNLICHES IM ANGEBOT / SIMILAR IN THE OFFER

SLIM8
AC2/Z



SMART10
AC2/Z

SURFACE10
BC/UX

BEGTON12
J/S

ARC12
CD/R

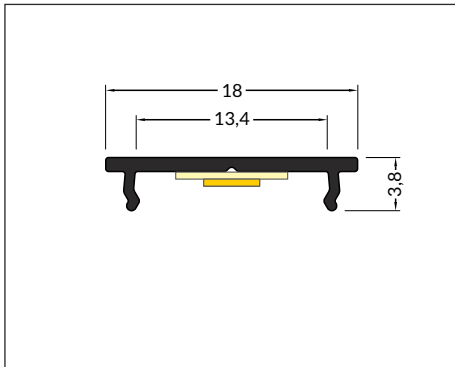
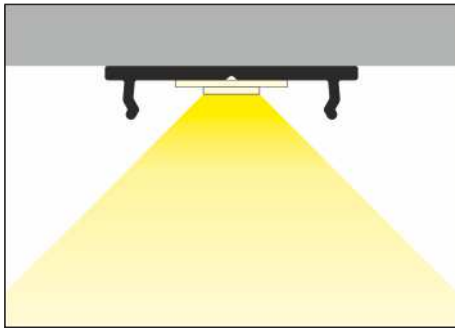
SURFACE14
EF/TY



max 12 mm



spezielle Profile
special application



Die Montage mit Hilfe
von Schrauben oder einem
doppelseitigem Klebeband
mounting with screws
or adhesive tape



Artikelnummer = 1 Stück,
Länge 2.000 mm,
Verpackung > siehe bitte Preisliste
INDEX = 1 pc, length 2000 mm
package > check the pricelist

eloxiert
anodized
87030020



Rohaluminium
raw aluminium
87030000

Die zugänglichen Längen: 1000 mm, 2000 mm, 3000 mm, 4000 mm.
Die standardmäßige Toleranz der Länge von Profilen beträgt: +20 mm.
Mehr Informationen >> 1.08.

Available lengths: 1000 mm, 2000 mm, 3000 mm, 4000 mm.
The standard profile length tolerance is +20 mm.
More details >> 1.08.

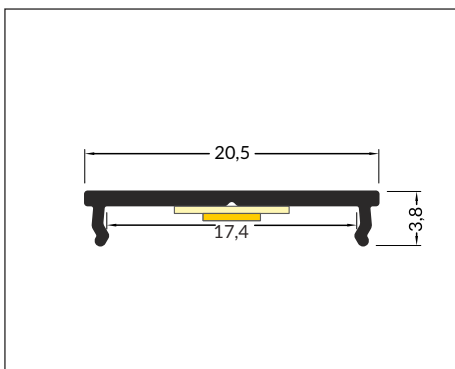
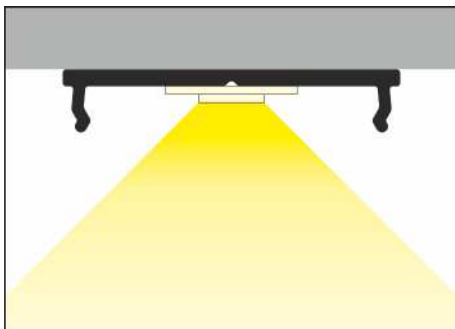

max 16 mm



spezielle Profile
special application



Die Montage mit Hilfe
von Schrauben oder einem
doppelseitigem Klebeband
mounting with screws
or adhesive tape



Artikelnummer = 1 Stück,
Länge 2.000 mm,
Verpackung > siehe bitte Preisliste
INDEX = 1 pc, length 2000 mm
package > check the pricelist

weiß lackiert
white painted
C6020001



eloxiert
anodized
C6020020



schwarz eloxiert
black anodized
C6020021



Rohaluminium
raw aluminium
C6020000

Die zugänglichen Längen: 1000 mm, 2000 mm, 3000 mm, 4000 mm.
Die standardmäßige Toleranz der Länge von Profilen beträgt: +20 mm.
Mehr Informationen >> 1.08.

Available lengths: 1000 mm, 2000 mm, 3000 mm, 4000 mm.
The standard profile length tolerance is +20 mm.
More details >> 1.08.

WALLE12 BCD

EIN WANDPROFIL

WALL-MOUNTED PROFILE

- die Montage direkt an der Wand oder Decke
 - 6 Abdeckungen zur Wahl
 - Montage im Außenbereich möglich
(bei dem Anwenden einer D klick Abdeckung und eines wasserdichten LED Streifens)
 - maximale Breite des LED Streifens 12 mm
-
- mounted directly to a wall or ceiling
 - 6 types of matching covers
 - possibility of outdoor using (with D cover and waterproof LED strip)
 - maximum LED strip width: 12 mm

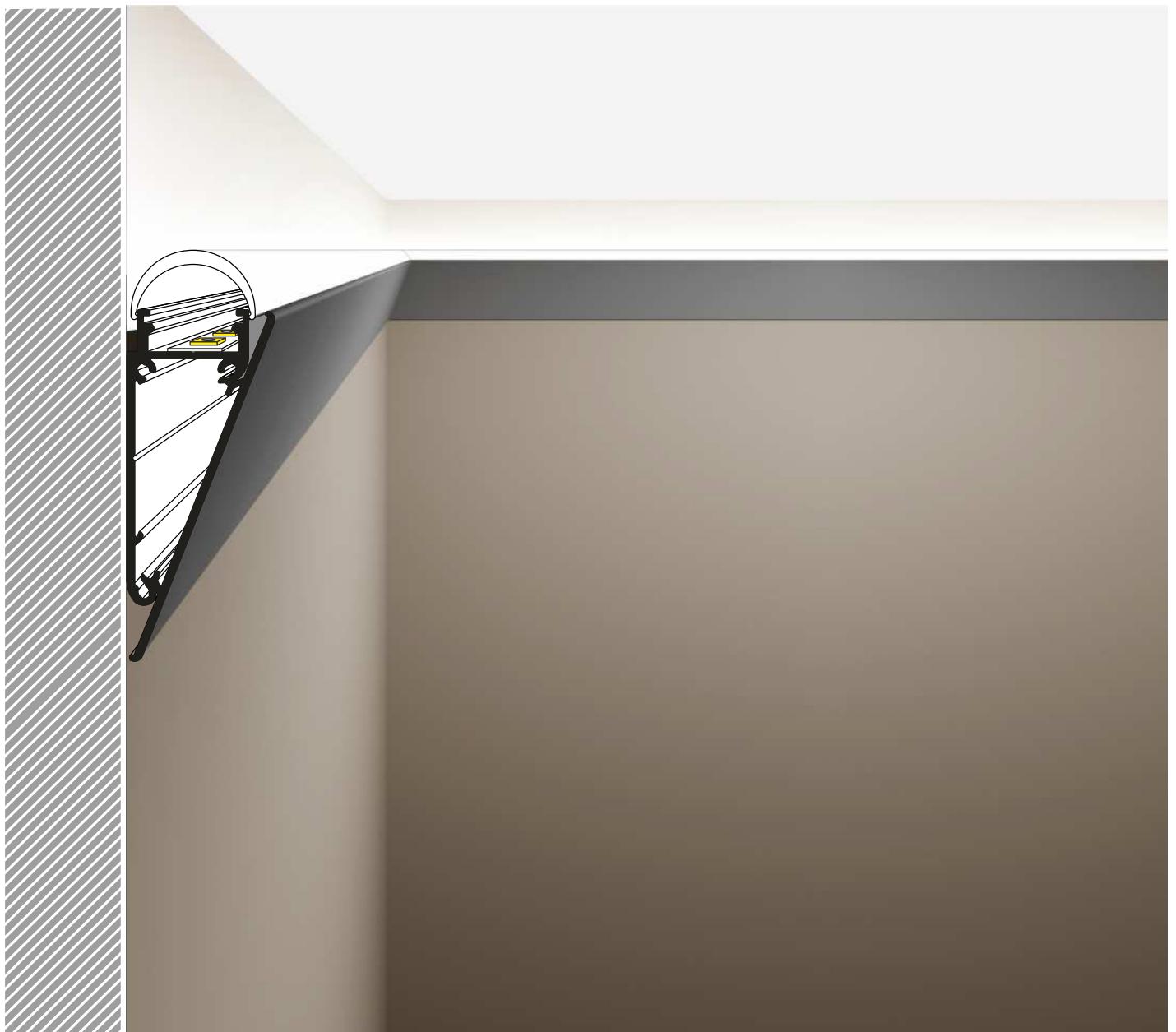

ÄHNLICHES IM ANGEBOT / SIMILAR IN THE OFFER



WAY10
C



FLAT8
H/UX



BACK10
A/UX



FRAME14
BC/Q



- B** Abdeckung **B** einschiebbar
B slide cover
- C** Abdeckung **C** einclipsbar
C click cover
- D** Abdeckung **D** einclipsbar
D click cover

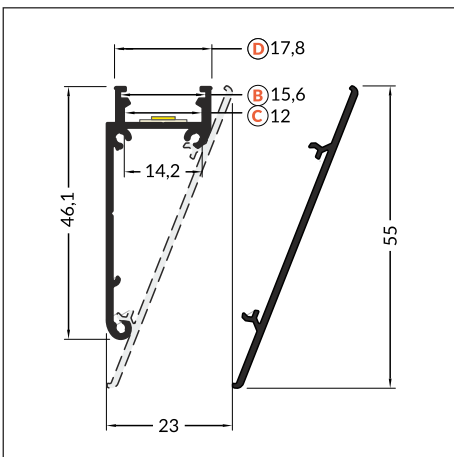
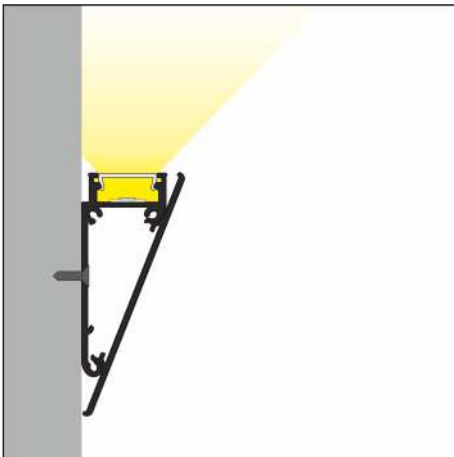
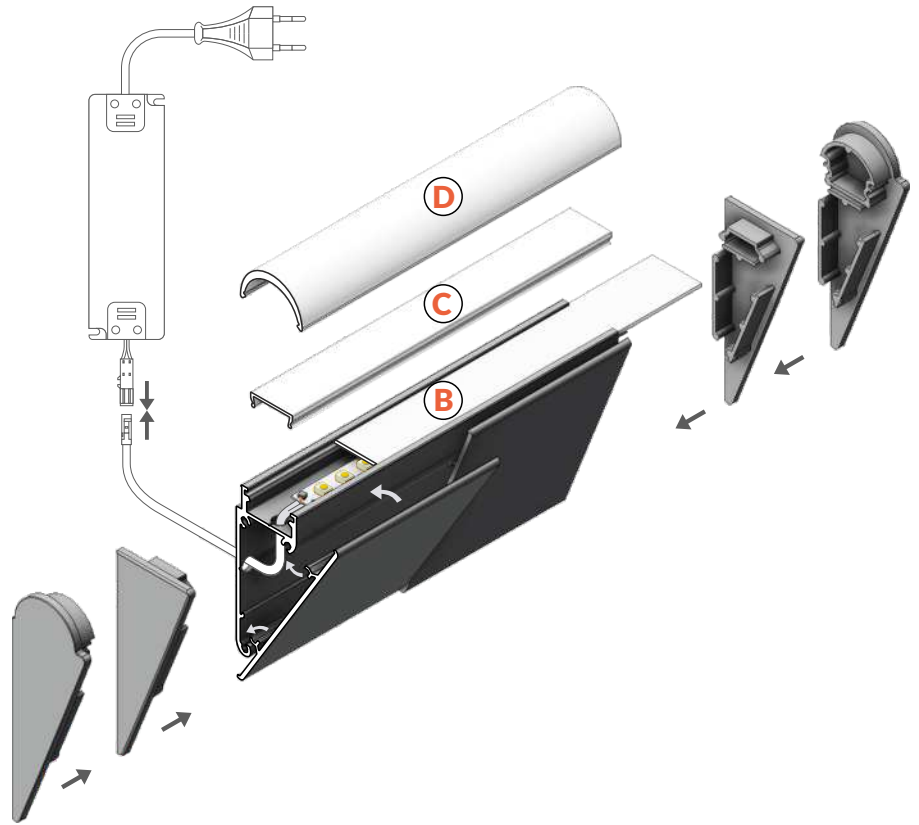

 max 12 mm

 spezielle Profile
special application

Artikelnummer = 1 Stück,
Länge 2.000 mm,
Verpackung > siehe bitte Preisliste
INDEX = 1 pc. length 2000 mm
package > check the pricelist

weiß lackiert
white painted
B8060001

eloxiert
anodized
B8020020

Rohaluminium
raw aluminium
C8020000



Die zugänglichen Längen: 1000 mm, 2000 mm, 3000 mm, 4000 mm.
Die standardmäßige Toleranz der Länge von Profilen beträgt: +20 mm.
Mehr Informationen >> 1.08.

Available lengths: 1000 mm, 2000 mm, 3000 mm, 4000 mm.
The standard profile length tolerance is +20 mm.
More details >> 1.08.



ABDECKUNG / COVERS

Abdeckung B einschiebbar
Farben: transparent, satiniert, opal
Material: PC, PP, PP

B slide cover
colours: transparent, frosted, opal
material: PC, PP, PP

Abdeckung C einclipsbar
Farben: transparent, opal
Material: PMMA

C click cover
colours: transparent, opal
material: PMMA

Abdeckung D einclipsbar
Farben: opal
Material: PMMA

D click cover
colour: opal
material: PMMA



Achtung! Die Abmessungen des Platzes für die Montage von LED Lichtquelle
Note! Dimensions of the space to install LED source

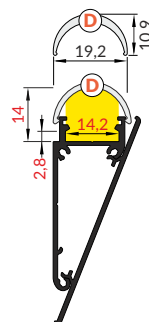
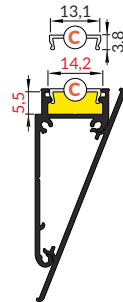
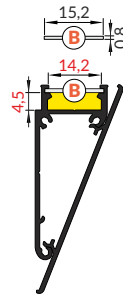

NEU



Länge 2.000 mm,
Verpackung > siehe bitte Preisliste
length 2000 mm
package > check the pricelist

B transparent
Artikelnummer = 10 Stück
index = 10 pcs
76250016

B satiniert / B frosted
Artikelnummer = 10 Stück
index = 10 pcs
76250039

B opal
Artikelnummer = 10 Stück
index = 10 pcs
76250038

C transparent
Artikelnummer = 1 Stück
index = 1 pc
76330000

C opal
Artikelnummer = 1 Stück
index = 1 pc
76330038

Rolle, Länge 20 m,
Verpackung > siehe bitte Preisliste
reel, length 20 m
package > check the pricelist

C opal
Artikelnummer = 1 Stück
index = 1 pc
76360038S

Länge 2.000 mm,
Verpackung > siehe bitte Preisliste
length 2000 mm
package > check the pricelist

D opal
Artikelnummer = 1 Stück
index = 1 pc
A1140038

Die Toleranz der Länge von Abdeckungen beträgt: +20 mm.
Mehr Informationen >> 1.08.
The standard cover length tolerance is +20 mm.
More details >> 1.08.

ENDKAPPEN / ENDINGS

Endkappe WALLE12
Farben: weiß, silbern, grau
Material: ABS

WALLE12 ending
colours: white, silver, grey
material: ABS

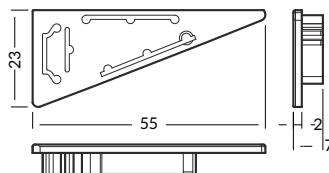

Artikelnummer = 10 Sets = 20 Stück
Verpackung > siehe bitte Preisliste
INDEX = 10 sets = 20 pcs
package > check the pricelist

weiß / white
B8900001

silbern / silver
B8900040

grau / grey
B8900022

Endkappe WALLE12 D
Farben: weiß, silbern, grau
Material: ABS

WALLE12 D ending
colours: white, silver, grey
material: ABS

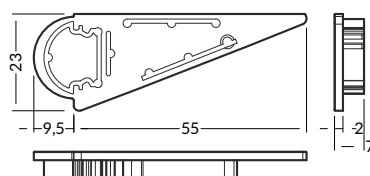

weiß / white
B8890001

silbern / silver
B8890040

grau / grey
B8890022



ALUMINIUMABDECKPLATTE / COVER

Aluminiumabdeckplatte für das LED Profil WALLE12

Farben: weiß, eloxiert

Material: Aluminium

WALLE12 cover

colours: white, anodized

material: aluminium



Artikelnummer = 1 Stück,
Länge 2.000 mm,
Verpackung > siehe bitte Preisliste
INDEX = 1 pc, length 2000 mm
package > check the pricelist

weiß lackiert / white painted
B8080001

eloxiert / anodized
B8040020

Die zugänglichen Längen: 1000 mm, 2000 mm, 3000 mm, 4000 mm.
Die standardmäßige Toleranz der Länge von Profilen beträgt: +20 mm.
Mehr Informationen >> 1.08.

Available lengths: 1000 mm, 2000 mm, 3000 mm, 4000 mm.
The standard profile length tolerance is +20 mm. More details >> 1.08.

VERBINDUNGSSTÜCKE / CONNECTORS

Verbinder 180 Grad für WALLE12

Farben: inox

material: rostfreier Stahl

WALLE12 connector 180 deg

colour: inox

material: stainless steel

Verbinder 90 Grad für WALLE12

Farben: weiß, eloxiert

Material: Aluminium

WALLE12 connector 90 deg

colours: white, anodized

material: aluminium

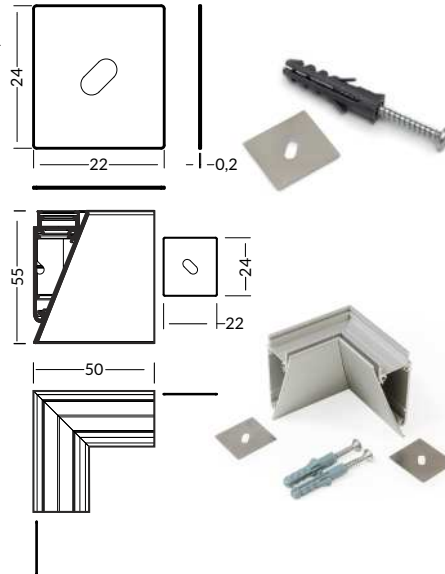

Artikelnummer = 1 Set,
Verpackung > siehe bitte Preisliste
INDEX = 1 set
package > check the pricelist

inox
B8950019

weiß lackiert
white painted
B8910001

eloxiert
anodized
B8910020



PEN12 CJ

DREHSYSTEM FÜR EXPOSITIONSBELEUCHTUNG

ROTATABLE DISPLAY LIGHTING SYSTEM

- für Wände und Möbel
- unterschiedliche Halterungen
- maximum LED strip width: 12 mm

- wall and furniture application
- various types of mounting brackets
- maximum LED strip width: 12 mm



ÄHNLICHES IM ANGEBOT / SIMILAR IN THE OFFER



PEN8
I



CABI12
E



CORNER10
BC/UX



TRIO10
BC



OVAL20
BC



- J** Abdeckung **J** einschiebbar
J slide cover
- C** Abdeckung **C** einclipsbar
C click cover
- C** Abdeckung **C** einclipsbar Linse
C lens cover

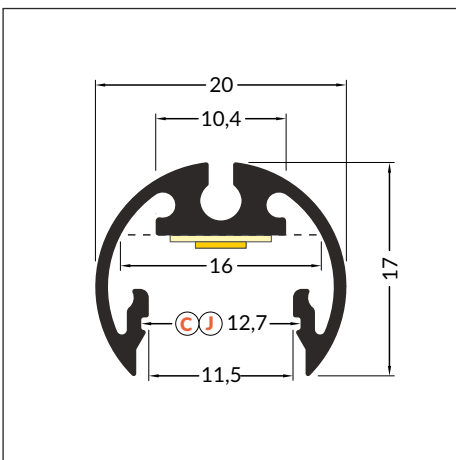
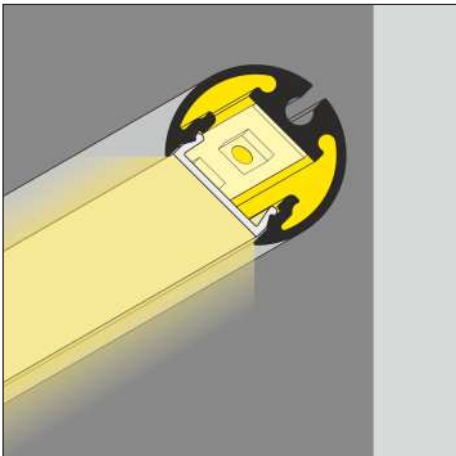
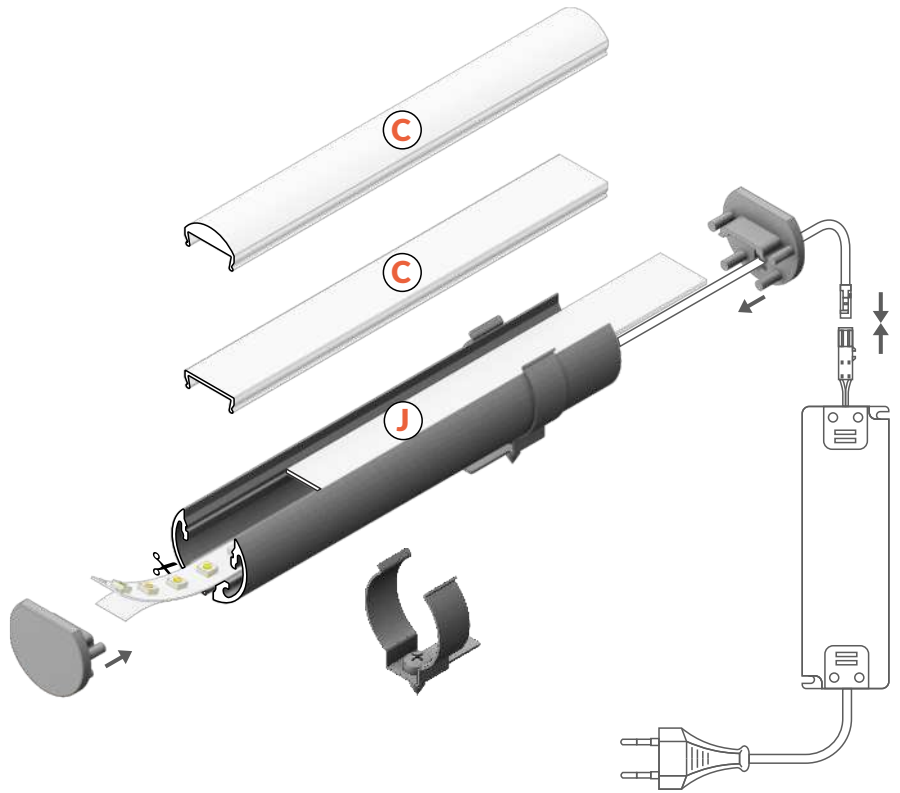

max 12 mm



spezielle Profile
special application



Artikelnummer = 1 Stück,
Länge 2.000 mm,
Verpackung > siehe bitte Preisliste
INDEX = 1 pc, length 2000 mm
package > check the pricelist

weiß lackiert
white painted
F7000201



eloxiert
anodized
F7000220



schwarz lackiert
black painted
F7000202

Die zugänglichen Längen: 1000 mm, 2000 mm, 3000 mm, 4000 mm.
Die standardmäßige Toleranz der Länge von Profilen beträgt: +20 mm.
Mehr Informationen >> 1.08.

Available lengths: 1000 mm, 2000 mm, 3000 mm, 4000 mm.
The standard profile length tolerance is +20 mm.
More details >> 1.08.



ABDECKUNG / COVERS

Abdeckung J einschiebbar
Farben: transparent, satiniert, opal
Material: PC, PP, PP

J slide cover
colours: transparent, frosted, opal
material: PC, PP, PP



Achtung! Die Abmessungen des Platzes für die Montage von LED Lichtquelle
Note! Dimensions of the space to install LED source

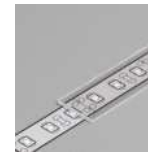
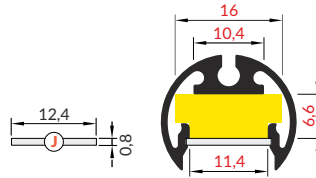

Länge 2.000 mm,
Verpackung > siehe bitte Preisliste
length 2000 mm
package > check the pricelist

J transparent
Artikelnummer = 10 Stück
index = 10 pcs
70330016



J satiniert / J frosted
Artikelnummer = 10 Stück
index = 10 pcs
70330039

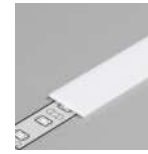

J opal
Artikelnummer = 10 Stück
index = 10 pcs
70330038



C transparent
Artikelnummer = 1 Stück
index = 1 pc
76330000



C opal
Artikelnummer = 1 Stück
index = 1 pc
76330038

Abdeckung C einclipsbar
Farben: transparent, opal
Material: PMMA

C click cover
colours: transparent, opal
material: PMMA

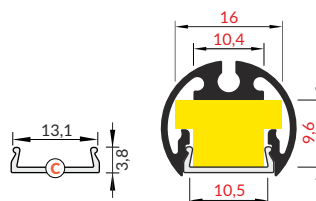

Rolle, Länge 20 m,
Verpackung > siehe bitte Preisliste
reel, length 20 m
package > check the pricelist

C opal
Artikelnummer = 1 Stück
index = 1 pc
76360038S



Länge 2.000 mm,
Verpackung > siehe bitte Preisliste
length 2000 mm
package > check the pricelist

C Linse / C lens
Artikelnummer = 1 Stück
index = 1 pc
76300000

Abdeckung C einclipsbar Linse
Farben: transparent
Material: PC

C click cover lens
colour: transparent
material: PC

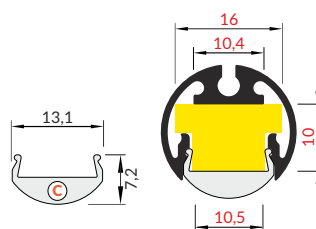

NEU

Die Toleranz der Länge von Abdeckungen beträgt: +20 mm.
Mehr Informationen >> 1.08.
The standard cover length tolerance is +20 mm.
More details >> 1.08.

ENDKAPPEN / ENDINGS

Endkappe PEN12
Farben: weiß, silbern, schwarz, grau
Material: ABS

PEN12 ending
colours: white, silver, black, grey
material: ABS



Die Endkappe mit Punkten für das Bohren von Öffnungen.
Ending with marked space to bore the holes.

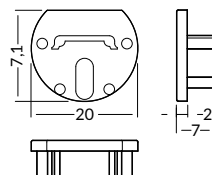

Artikelnummer = 10 Sets = 20 Stück
Verpackung > siehe bitte Preisliste
INDEX = 10 sets = 20 pcs
package > check the pricelist

weiß / white
F7009901

silbern / silver
F7009940

schwarz / black
F7009902

grau / grey
F7009922

HALTER / MOUNTINGS

Halter PEN12 flach
Farben: inox
Material: rostfreier Stahl

PEN12 flat holder
colour: inox
material: stainless steel

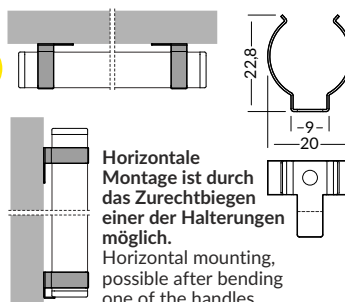

Horizontale Montage ist durch das Zurechtbiegen einer der Halterungen möglich.
Horizontal mounting, possible after bending one of the handles.



Artikelnummer = 10 Sets = 20 Stück
Verpackung > siehe bitte Preisliste
INDEX = 10 sets = 20 pcs
package > check the pricelist

inox
F7009019



HALTER / MOUNTINGS

Dübelhalter PEN12

Farben: Chrom
Material: Messing

PEN12 stretcher holder
colour: chrome
material: brass

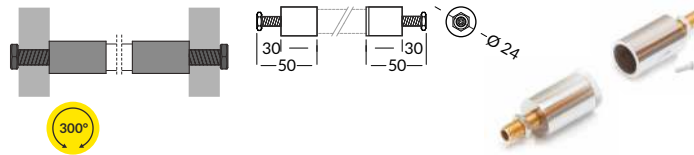

Artikelnummer = 1 Set = 2 Stück
Verpackung > siehe bitte Preisliste
INDEX = 1 set = 2 pcs
package > check the pricelist

Chrom / chrome
F7009103

Montagering PEN12

Farben: Chrom
Material: Messing

PEN12 ring holder
colours: chrome
material: brass

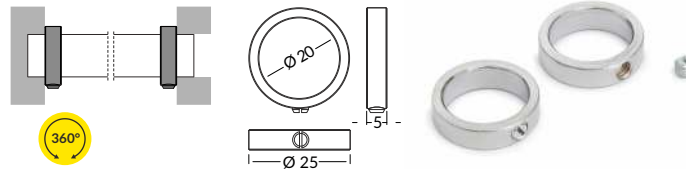

Chrom / chrome
F7009203

Doppelhalter mit Gewinde für PEN12

Farben: Chrom
Material: Stahl, Messing

PEN12 double holder with thread
colour: chrome
material: steel, brass

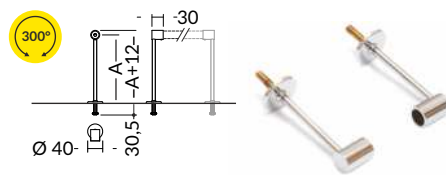

A =

100 mm	F7009303
200 mm	F7009403
300 mm	F7009503

Doppelhalter mit Deckenhalter für PEN12

Farben: Chrom
Material: Stahl, Messing

PEN12 double holder with soffit ceiling
colour: chrome
material: steel, brass

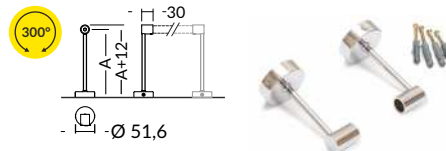

A =

100 mm	F7009603
200 mm	F7009703
300 mm	F7009803

Halter PEN12 Wandausleger

Farben: weiß, silbern, schwarz
Material: Stahl, Messing

PEN12 wall-mounted extension arm
colours: white, silver, black
material: steel, brass

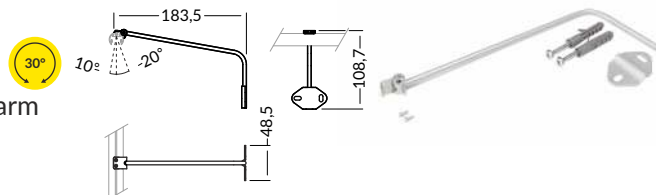

Artikelnummer = 1 Set = 1 Stück
Verpackung > siehe bitte Preisliste
INDEX = 1 set = 1 pc
package > check the pricelist

weiß white	F7008801
silbern silver	F7008822
schwarz black	F7008802

Halter PEN12 Schrankausleger

Farben: weiß, silbern, schwarz
Material: Stahl, Messing

PEN12 cabinet-mounted extension arm
colours: white, silver, black
material: steel, brass

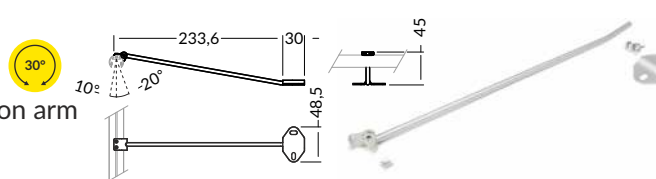

weiß white	F7008901
silbern silver	F7008922
schwarz black	F7008902



FAMILIE DER PROFILE ZUR UNTERFLIESEN-MONTAGE

FAMILY OF PROFILES FOR UNDER-TILE MOUNTING

- drei Montagewinkel zugänglich: 90 / 180 / 270 Grad
- für Fliesen bis 10 mm Dicke
- zugängliche Version mit dem fertigen Montageloch
- maximale Breite des LED Streifens 12 mm

- three mounting angles available: 90, 180, 270 degrees
- for 10 mm tiles
- version with perforated mounting holes available
- maximum LED strip width: 12 mm



ÄHNLICHES IM ANGEBOT / SIMILAR IN THE OFFER



UNI-TILE12 90 Grad/deg C



C Abdeckung **C** einclipsbar
C click cover

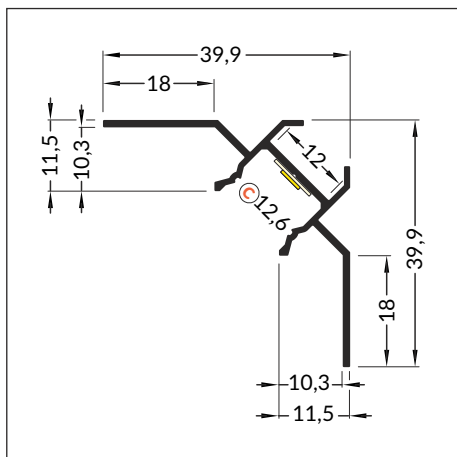
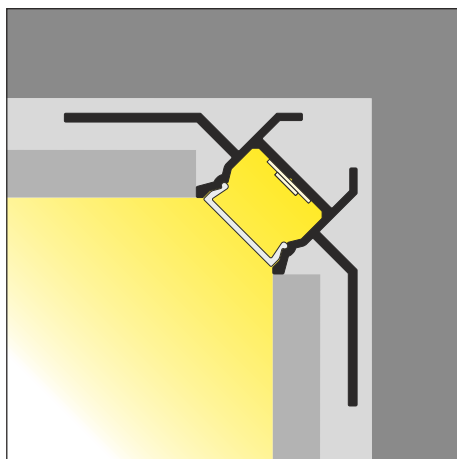
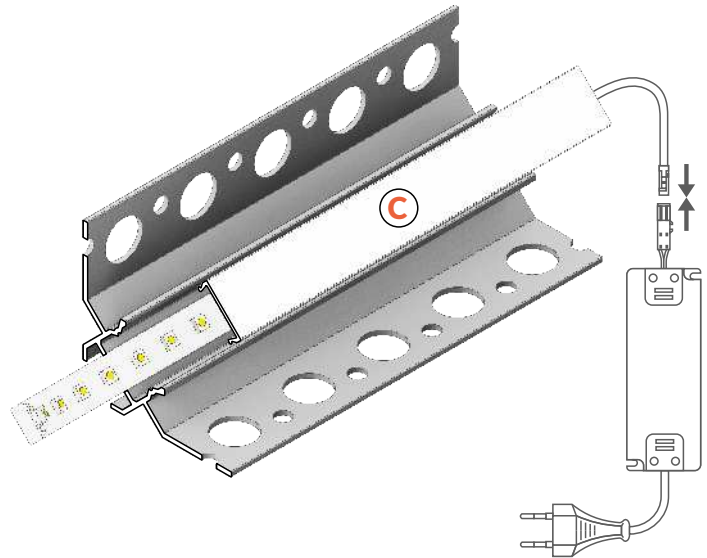

Artikelnummer = 1 Stück, Länge 2.000 mm, Verpackung > siehe bitte Preisliste
 INDEX = 1 pc, length 2000 mm, package > check the pricelist

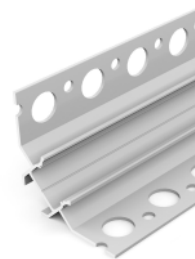

90 Grad PLUS
 eloxiert
 anodized
G4000620

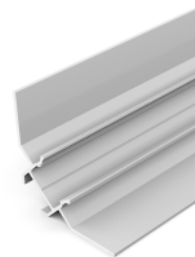

90 Grad
 eloxiert
 anodized
G4000220



max 12 mm



spezielle Profile
 special application

Zugängliche Längen der Version PLUS: 1000 mm, 2000 mm, 2500 mm, 3000 mm, 4000 mm.
 Zugängliche Längen der Standardversion: 1000 mm, 2000 mm, 3000 mm, 4000 mm.
 Die standardmäßige Toleranz der Länge von Profilen beträgt: +20 mm.
 Mehr Informationen >> 1.08.

PLUS version available lengths: 1000 mm, 2000 mm, 2500 mm, 3000 mm, 4000 mm.
 Standard version available lengths: 1000 mm, 2000 mm, 3000 mm, 4000 mm.
 The standard profile length tolerance is +20 mm. More details >> 1.08.

UNI-TILE12 180 Grad/deg C



C Abdeckung **C** einclipsbar
C click cover

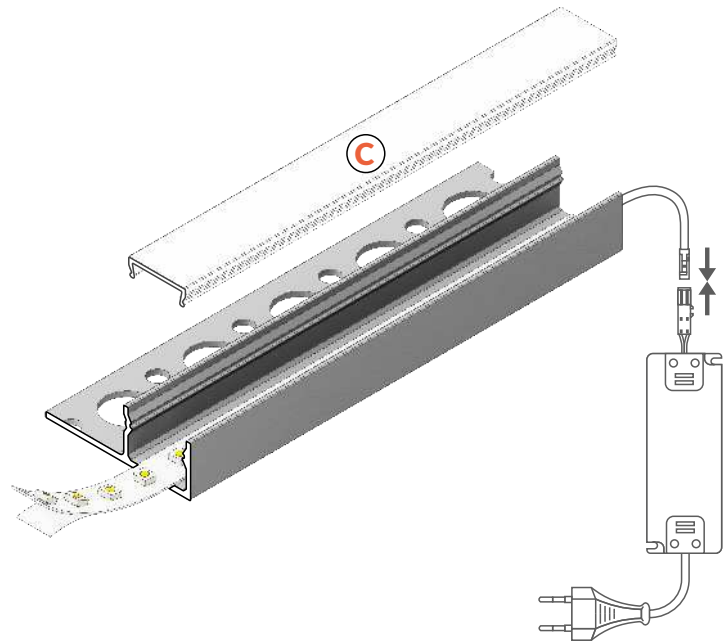
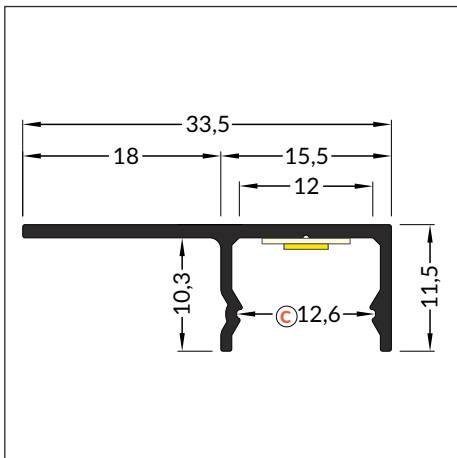
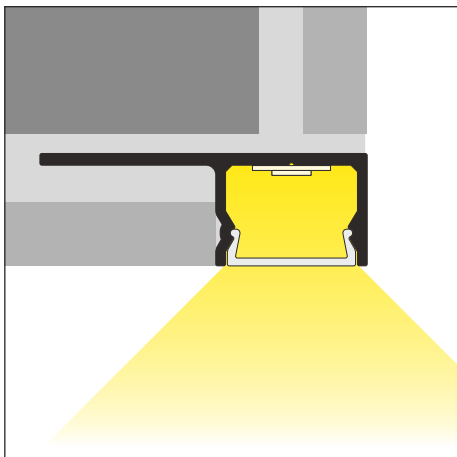
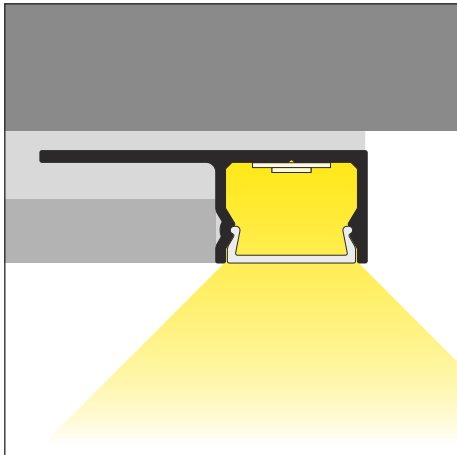

Artikelnummer = 1 Stück, Länge 2.000 mm, Verpackung > siehe bitte Preisliste
 INDEX = 1 pc, length 2000 mm, package > check the pricelist

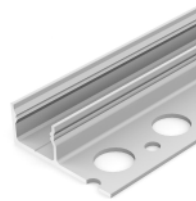

180 Grad PLUS
 eloxiert
 anodized
G2000620

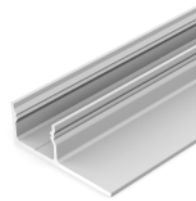

180 Grad
 eloxiert
 anodized
G2000220



max 12 mm



spezielle Profile
 special application

Zugängliche Längen der Version PLUS: 1000 mm, 2000 mm, 2500 mm, 3000 mm, 4000 mm.
 Zugängliche Längen der Standardversion: 1000 mm, 2000 mm, 3000 mm, 4000 mm.
 Die standardmäßige Toleranz der Länge von Profilen beträgt: +20 mm.
 Mehr Informationen >> 1.08.

PLUS version available lengths: 1000 mm, 2000 mm, 2500 mm, 3000 mm, 4000 mm.
 Standard version available lengths: 1000 mm, 2000 mm, 3000 mm, 4000 mm.
 The standard profile length tolerance is +20 mm. More details >> 1.08.

UNI-TILE12 270 Grad/deg C



C Abdeckung **C** einclipsbar
C click cover

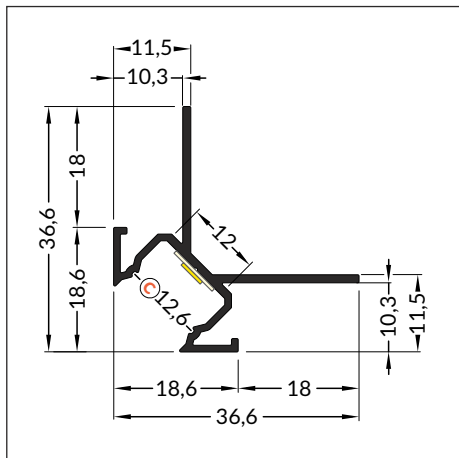
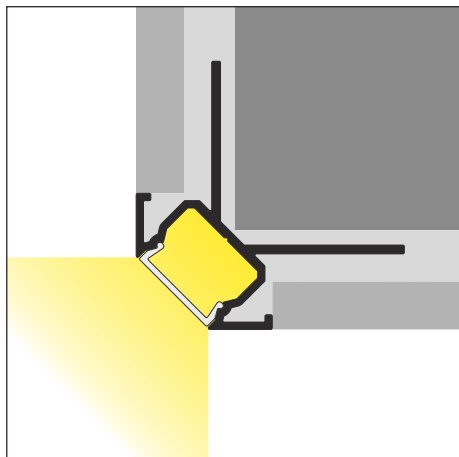
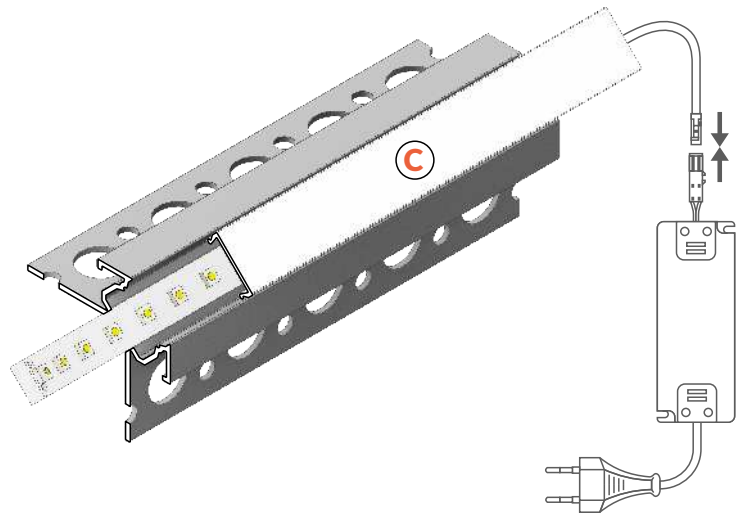

Artikelnummer = 1 Stück, Länge 2.000 mm, Verpackung > siehe bitte Preisliste
 INDEX = 1 pc, length 2000 mm, package > check the pricelist

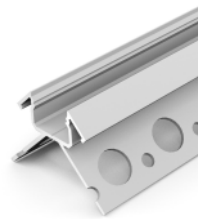

270 Grad PLUS
 eloxiert
 anodized
G3000620



270 Grad
 eloxiert
 anodized
G3000220



max 12 mm



spezielle Profile
 special application

Zugängliche Längen der Version PLUS: 1000 mm, 2000 mm, 2500 mm, 3000 mm, 4000 mm.
 Zugängliche Längen der Standardversion: 1000 mm, 2000 mm, 3000 mm, 4000 mm.
 Die standardmäßige Toleranz der Länge von Profilen beträgt: +20 mm.
 Mehr Informationen >> 1.08.

PLUS version available lengths: 1000 mm, 2000 mm, 2500 mm, 3000 mm, 4000 mm.
 Standard version available lengths: 1000 mm, 2000 mm, 3000 mm, 4000 mm.
 The standard profile length tolerance is +20 mm. More details >> 1.08.



ABDECKUNG / COVERS

Abdeckung **C** einclipsbar
Farben: transparent, opal
Material: PMMA

C click cover
colours: transparent, opal
material: PMMA



Achtung! Die Abmessungen des Platzes für die Montage von LED Lichtquelle
Note! Dimensions of the space to install LED source

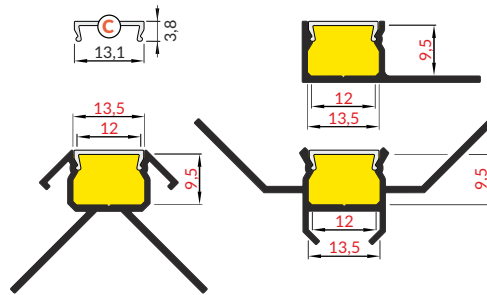

Länge 2.000 mm,
Verpackung > siehe bitte Preisliste
length 2000 mm
package > check the pricelist

C transparent
Artikelnummer = 1 Stück
index = 1 pc
76330000

C opal
Artikelnummer = 1 Stück
index = 1 pc
76330038

Rolle, Länge 20 m,
Verpackung > siehe bitte Preisliste
reel, length 20 m
package > check the pricelist

C opal
Artikelnummer = 1 Stück
index = 1 pc
76360038S



Die Toleranz der Länge von Abdeckungen beträgt: +20 mm.
Mehr Informationen >> 1.08.

The standard cover length tolerance is +20 mm.
More details >> 1.08.





FRAME14 BC/Q

EIN ALUMINIUM PROFIL FÜR RIGIPSPLETTEN

ALUMINIUM LED PROFILE FOR PLASTERBOARD

- vorgesehen für Rigipsplatten - eine dekorative Ausführung der Konstruktion
- eine homogene Lichtlinie (bei LED Streifen mit 120 leds/m und einer opalen Abdeckung)
- viele Anwendungsmöglichkeiten mit Hilfe von unterschiedlichen Verbindungsstücken.
- maximale Breite des LED Streifens 14 mm

- dedicated for plasterboards - decorative construction finish
- continuous line of light (when using LED strip 120 P/m and opal cover)
- multiple arrangements through a variety of connectors
- maximum LED strip width: 14 mm



ÄHNLICHES IM ANGEBOT / SIMILAR IN THE OFFER



FLAT8
H/UX



DEEP10
BC/UX



WALLE12
CD



UNI-TILE12
90 deg C



UNI-TILE12
180 deg C



UNI-TILE12
270 deg C



- B** Abdeckung **B** einschiebbar
B slide cover
- C** Abdeckung **C** einclipsbar
C click cover
- Q¹** Verbindungsstück **Q** 90 Grad gebogen
Q 90 deg bent connector
- Q²** Verbindungsstück **Q** 180 Grad
Q 180 deg connector
- Q³** Verbindungsstück **Q** 135 Grad
Q 135 deg connector
- Q⁴** Verbindungsstück **Q** 90 Grad
Q 90 deg connector

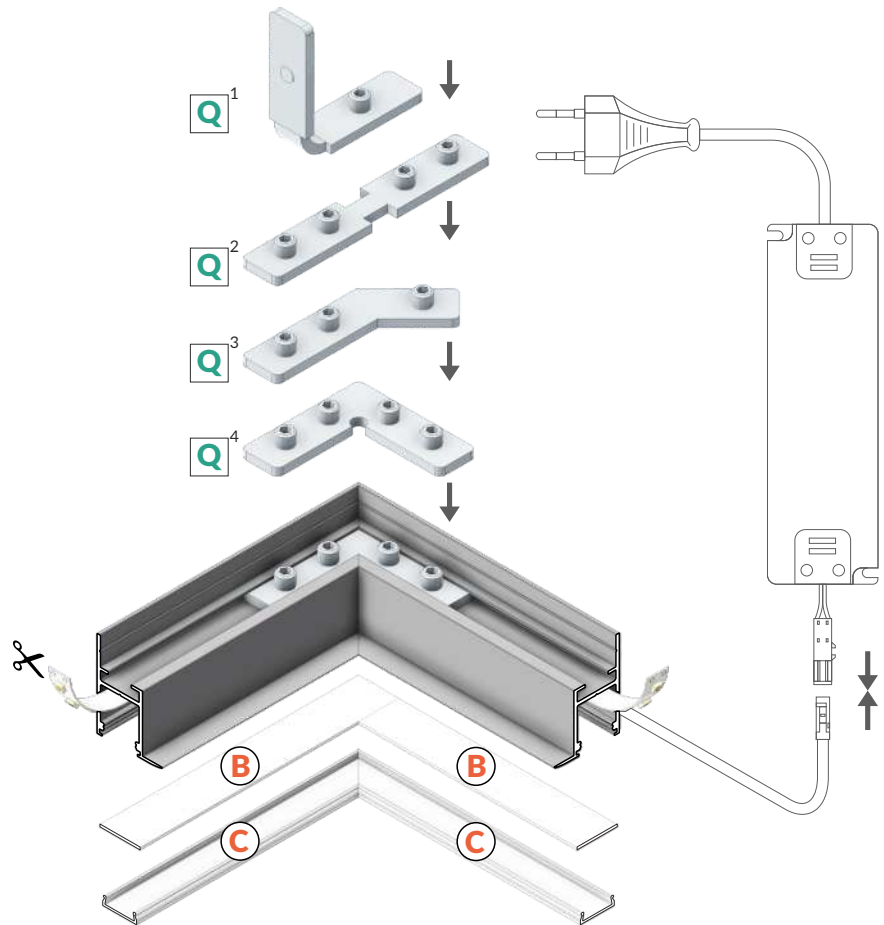
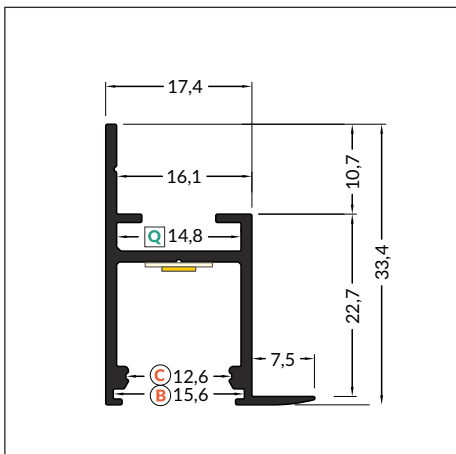
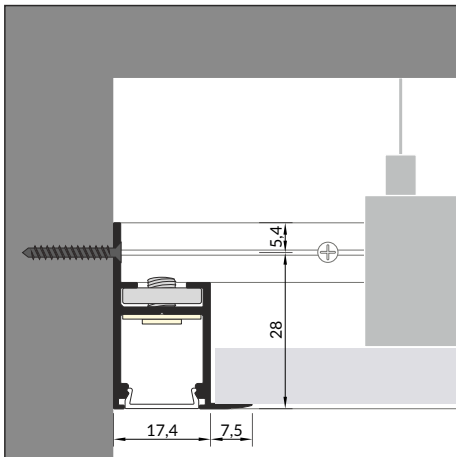
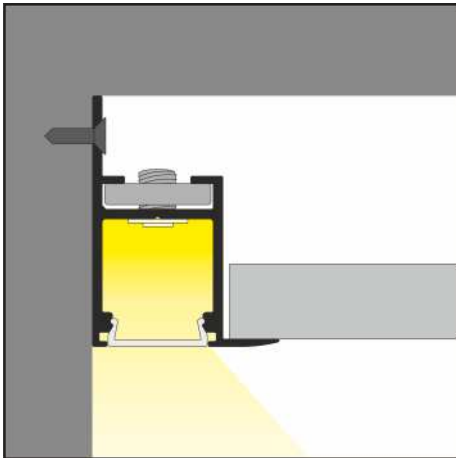

Artikelnummer = 1 Stück,
Länge 2.000 mm,
Verpackung > siehe bitte Preisliste
INDEX = 1 pc, length 2000 mm
package > check the pricelist

weiß lackiert
white painted
C3020001

eloxiert
anodized
C3020020

Rohaluminium
raw aluminium
C3020000

Achtung! Das Profil erfüllt keine Baufunktion.
Please note! The profile isn't a construction profile.



max 14 mm



spezielle Profile
special application



Die zugänglichen Längen: 1000 mm, 2000 mm, 3000 mm, 4000 mm.
Die standardmäßige Toleranz der Länge von Profilen beträgt: +20 mm.
Mehr Informationen >> 1.08.

Available lengths: 1000 mm, 2000 mm, 3000 mm, 4000 mm.
The standard profile length tolerance is +20 mm.
More details >> 1.08.



ABDECKUNG / COVERS

Abdeckung B einschiebbar
Farben: transparent, satiniert, opal
Material: PC, PP, PP

B slide cover
colours: transparent, frosted, opal
material: PC, PP, PP

Abdeckung C einclipsbar
Farben: transparent, opal
Material: PMMA

C click cover
colours: transparent, opal
material: PMMA

Achtung! Die Abmessungen des Platzes für die Montage von LED Lichtquelle
Note! Dimensions of the space to install LED source

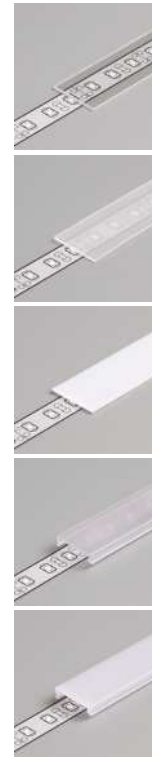
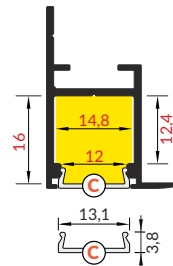
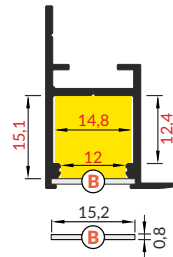

Länge 2.000 mm,
Verpackung > siehe bitte Preisliste
length 2000 mm
package > check the pricelist

B transparent
Artikelnummer = 10 Stück
index = 10 pcs
76250016

B satiniert / B frosted
Artikelnummer = 10 Stück
index = 10 pcs
76250039

B opal
Artikelnummer = 10 Stück
index = 10 pcs
76250038

C transparent
Artikelnummer = 1 Stück
index = 1 pc
76330000

C opal
Artikelnummer = 1 Stück
index = 1 pc
76330038

NEU



Rolle, Länge 20 m,
Verpackung > siehe bitte Preisliste
reel, length 20 m
package > check the pricelist

C opal
Artikelnummer = 1 Stück
index = 1 pc
76360038S

Die Toleranz der Länge von Abdeckungen beträgt: +20 mm.
Mehr Informationen >> 1.08.
The standard cover length tolerance is +20 mm.
More details >> 1.08.

VERBINDUNGSTÜCKE / CONNECTORS

Verbindungsstück Q
180 Grad / 135 Grad / 90 Grad
Material: verzinkter Stahl

Q 180 deg / 135 deg / 90 deg connector
material: zinc coated steel

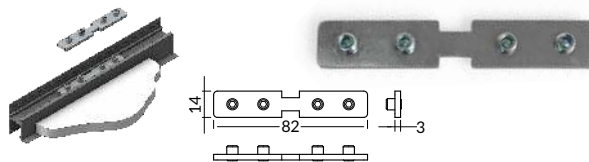

C3990030

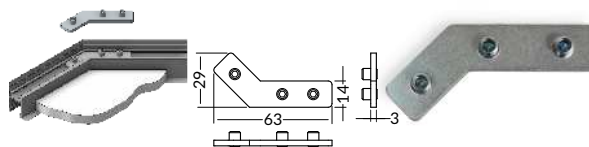

C3980030

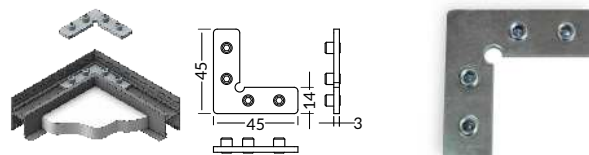

C3970030

Verbindungsstück Q 90 Grad gebogen
Material: verzinkter Stahl

Q 90 deg bent connector
material: zinc coated steel

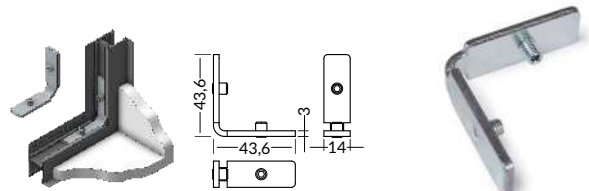

C3960030

Artikelnummer = 1 Set,
Verpackung > siehe bitte Preisliste
INDEX = 1 set
package > check the pricelist



OVAL20 BC

SCHRANKSTANGE MIT ZWEI FUNKTIONEN

A DOUBLE-FUNCTION BAR FOR WARDROBES

- Kleiderstange und Schrankbeleuchtung
 - drei Montagemöglichkeiten: von Wand zu Wand, als Wandausleger, als Deckenausleger
 - zwei Stufen des Einbaus von LED Streifen zur Wahl
 - maximale Breite des LED Streifens 20 mm
-
- a bar for hanging garments and illuminating the wardrobe
 - 3 mounting options: side-to-side, as an extension arm from a side, as an extension arm from the top
 - two LED strip installation depths to choose from
 - maximum LED strip width: 20 mm

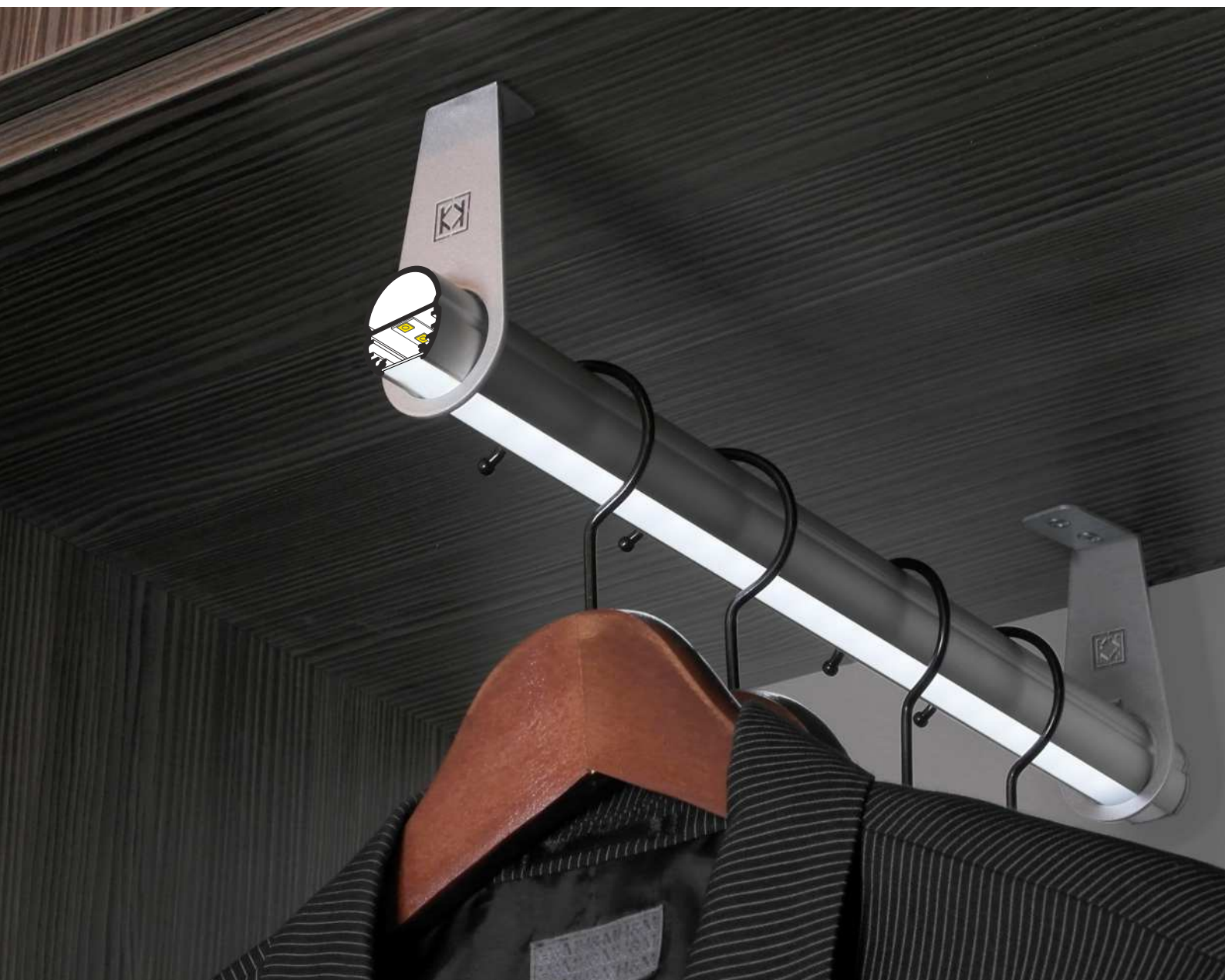

ÄHNLICHES IM ANGEBOT / SIMILAR IN THE OFFER



PEN8



PEN12



B Abdeckung **B** einschiebbar
B slide cover

C Abdeckung **C** einclipsbar
C click cover

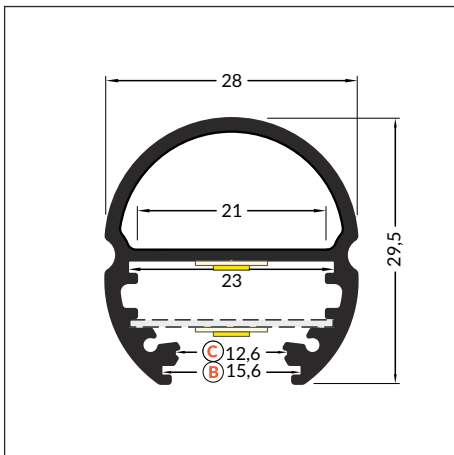
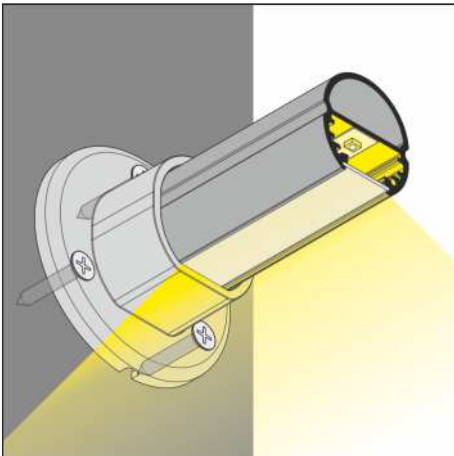
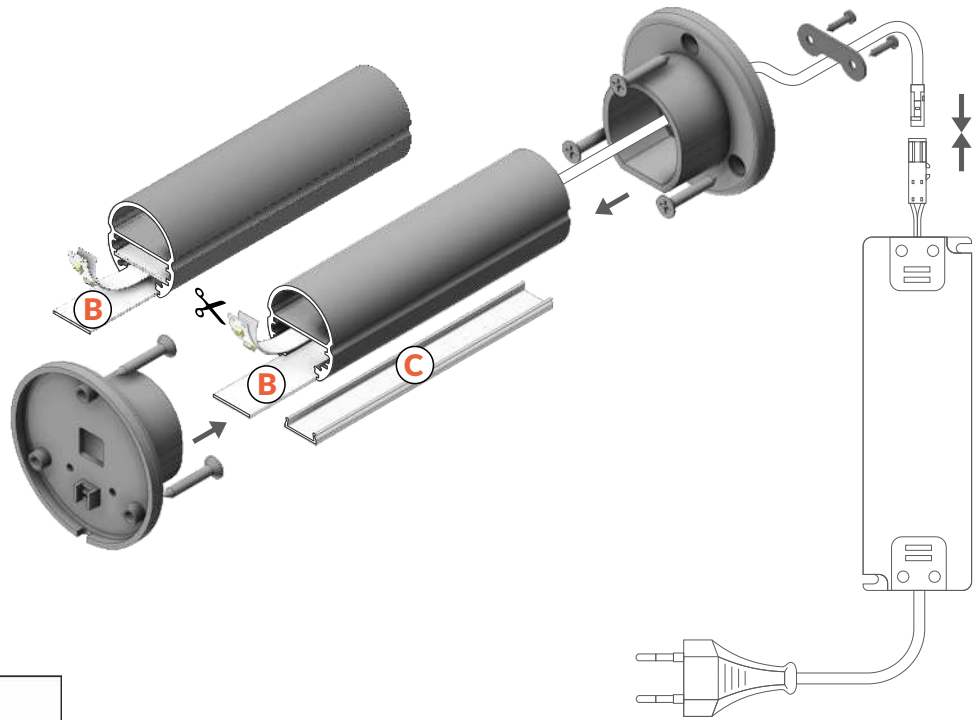

 max 20 mm

 spezielle Profile
special application

Artikelnummer = 1 Stück,
Länge 2.000 mm,
Verpackung > siehe bitte Preisliste
INDEX = 1 pc, length 2000 mm
package > check the pricelist

eloxiert
anodized
92030020



Die zugänglichen Längen: 1000 mm, 2000 mm, 3000 mm, 4000 mm.
Die standardmäßige Toleranz der Länge von Profilen beträgt: +20 mm.
Mehr Informationen >> 1.08.

Available lengths: 1000 mm, 2000 mm, 3000 mm, 4000 mm.
The standard profile length tolerance is +20 mm.
More details >> 1.08.



ABDECKUNG / COVERS

Abdeckung B einziehbar
Farben: transparent, satiniert, opal
Material: PC, PP, PP

B slide cover
colours: transparent, frosted, opal
material: PC, PP, PP



Achtung! Die Abmessungen des Platzes für die Montage von LED Lichtquelle
Note! Dimensions of the space to install LED source

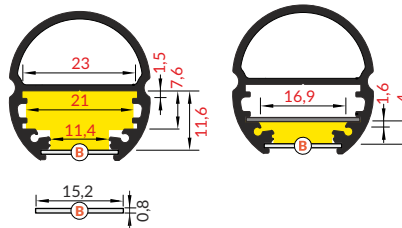

Länge 2.000 mm,
Verpackung > siehe bitte Preisliste
length 2000 mm
package > check the pricelist

B transparent

Artikelnummer = 10 Stück
index = 10 pcs

76250016

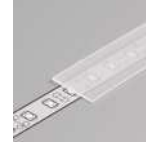

B satiniert / B frosted

Artikelnummer = 10 Stück
index = 10 pcs

76250039

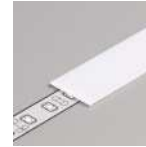

B opal

Artikelnummer = 10 Stück
index = 10 pcs

76250038

Abdeckung C einclipsbar
Farben: transparent, opal
Material: PMMA

C click cover
colours: transparent, opal
material: PMMA

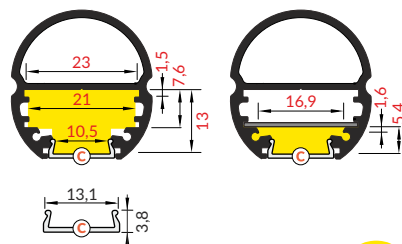

C transparent

Artikelnummer = 1 Stück
index = 1 pc

76330000



C opal

Artikelnummer = 1 Stück
index = 1 pc

76330038

NEU



Rolle, Länge 20 m,
Verpackung > siehe bitte Preisliste
reel, length 20 m
package > check the pricelist

C opal

Artikelnummer = 1 Stück
index = 1 pc

76360038S

Die Toleranz der Länge von Abdeckungen beträgt: +20 mm.
Mehr Informationen >> 1.08.

The standard cover length tolerance is +20 mm.
More details >> 1.08.

HALTER / MOUNTINGS

Seitenhalter OVAL20
Farben: silbern, grau
Material: ABS

OVAL20 side holder
colours: silver, grey
material: ABS

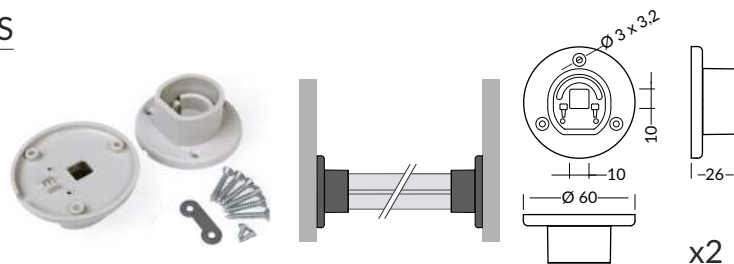

Artikelnummer = 1 Set,
Verpackung > siehe bitte Preisliste
INDEX = 1 set
package > check the pricelist

silbern / silver

92040040

grau / grey

92040022

x2

Einzelausleger für OVAL20
Farben: silbern
Material: ABS, Stahl, Aluminium

OVAL20 single extension arm
colour: silver
material: ABS, steel, aluminium

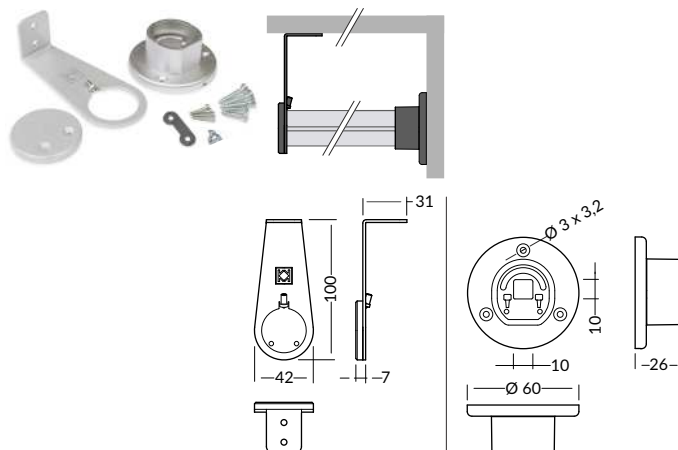

silbern / silver

92980040



HALTER / MOUNTINGS

Doppelausleger für OVAL20
Farben: silbern
Material: ABS, Stahl, Aluminium
 OVAL20 double extension arm
 colour: silver
 material: ABS, steel, aluminium

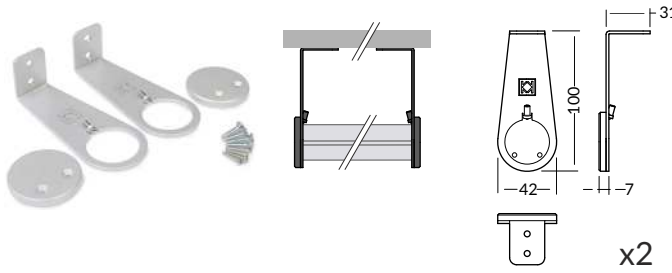

Artikelnummer = 1 Set,
 Verpackung > siehe bitte Preisliste
 INDEX = 1 set
 package > check the pricelist

silbern / silver
92990040

Halter OVAL20 einfach
Material: verzinkter Stahl
 OVAL20 simple holder
 material: zinc coated steel



verzinkt
 zinc coated
92070030

MONTAGETEIL FÜR LED / LED MOUNTING

LED Montageteil für OVAL20
Material: Aluminium
 OVAL20 LED mounting
 material: aluminium

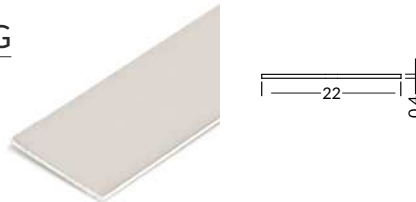

Artikelnummer = 1 Stück,
 Länge 2.000 mm,
 Verpackung > siehe bitte Preisliste
 INDEX = 1 pc, length 2000 mm
 package > check the pricelist

Rohaluminium
 raw aluminium
92100000

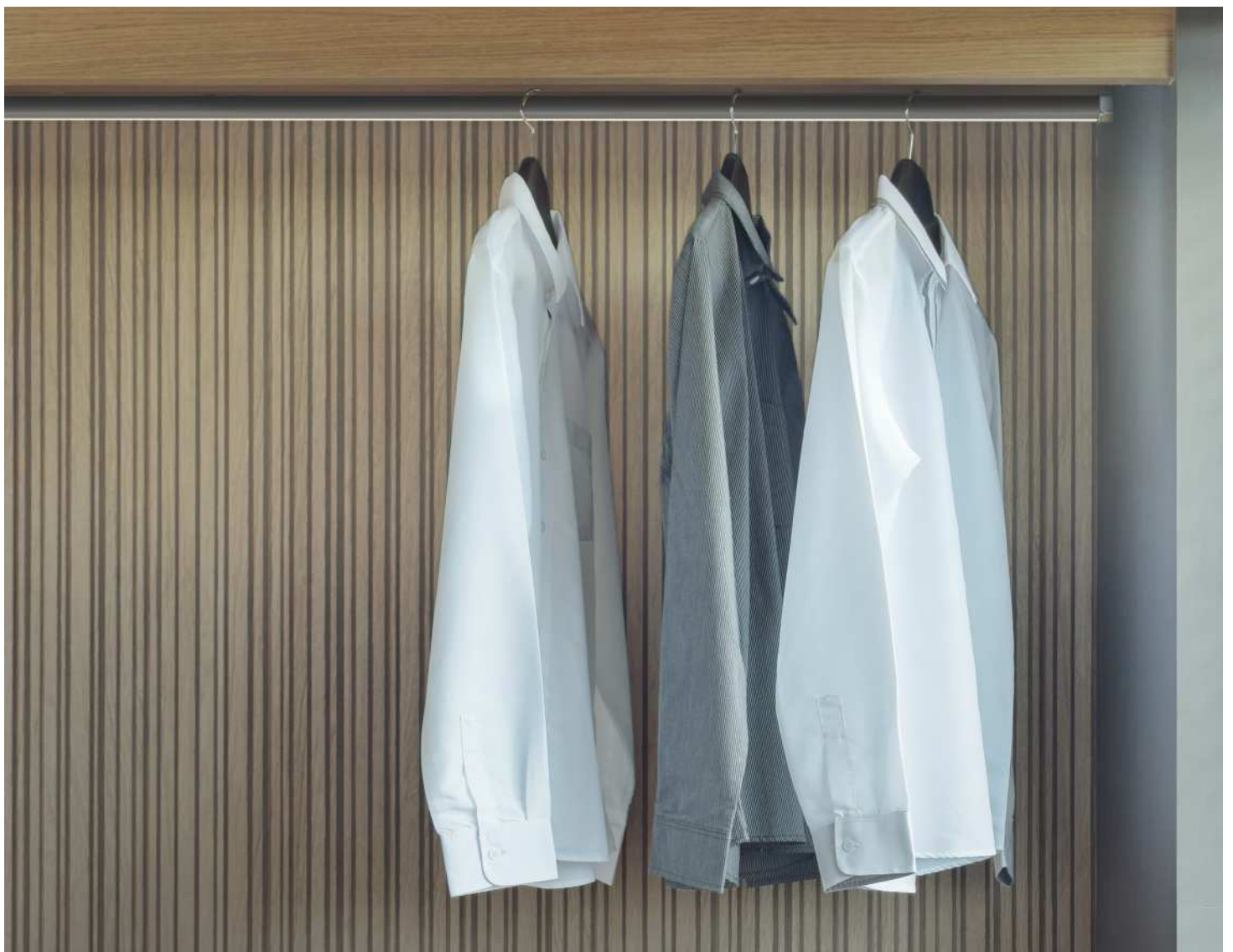



2020

LED PROFILE
LED PROFILES

GLASKANTENPROFILE / GLASS APPLICATION



TWIN8

KANTENPROFIL FÜR GLASBRETT - LEUCHTET IN ZWEI RICHTUNGEN

A TWO-WAY EDGE PROFILE FOR GLASS SHELVES

- dekorative Beleuchtung
 - die Montage an dem hinteren Glas-, Brettrand
 - zwei Leuchtrichtungen: nach oben und unten
 - es beleuchtet die innere Wand der Vitrine
 - zusätzlich die Beleuchtung des Glasrandes in der Version TWIN8 PLUS
 - geeignet für 8mm Glasböden
 - die Möglichkeit der Anwendung mit einer dünneren Scheibe - man muss zusätzliches Kleben mit einer Band voraussehen
 - Achtung: das Profil erfüllt keine Baufunktion
 - maximale Breite des LED Streifens 8 mm
-
- decorative illumination
 - mounted on the glass or shelf rear edge
 - 2 lighting directions: up and down
 - illuminating the rear side of a display case
 - additionally illumination of the glass edge with the TWIN8 PLUS profile
 - fits the 8 mm thick glass panel
 - when using on a thinner glass, consider additional adhesive tape
 - note: the profile is not a construction element
 - maximum LED strip width: 8 mm

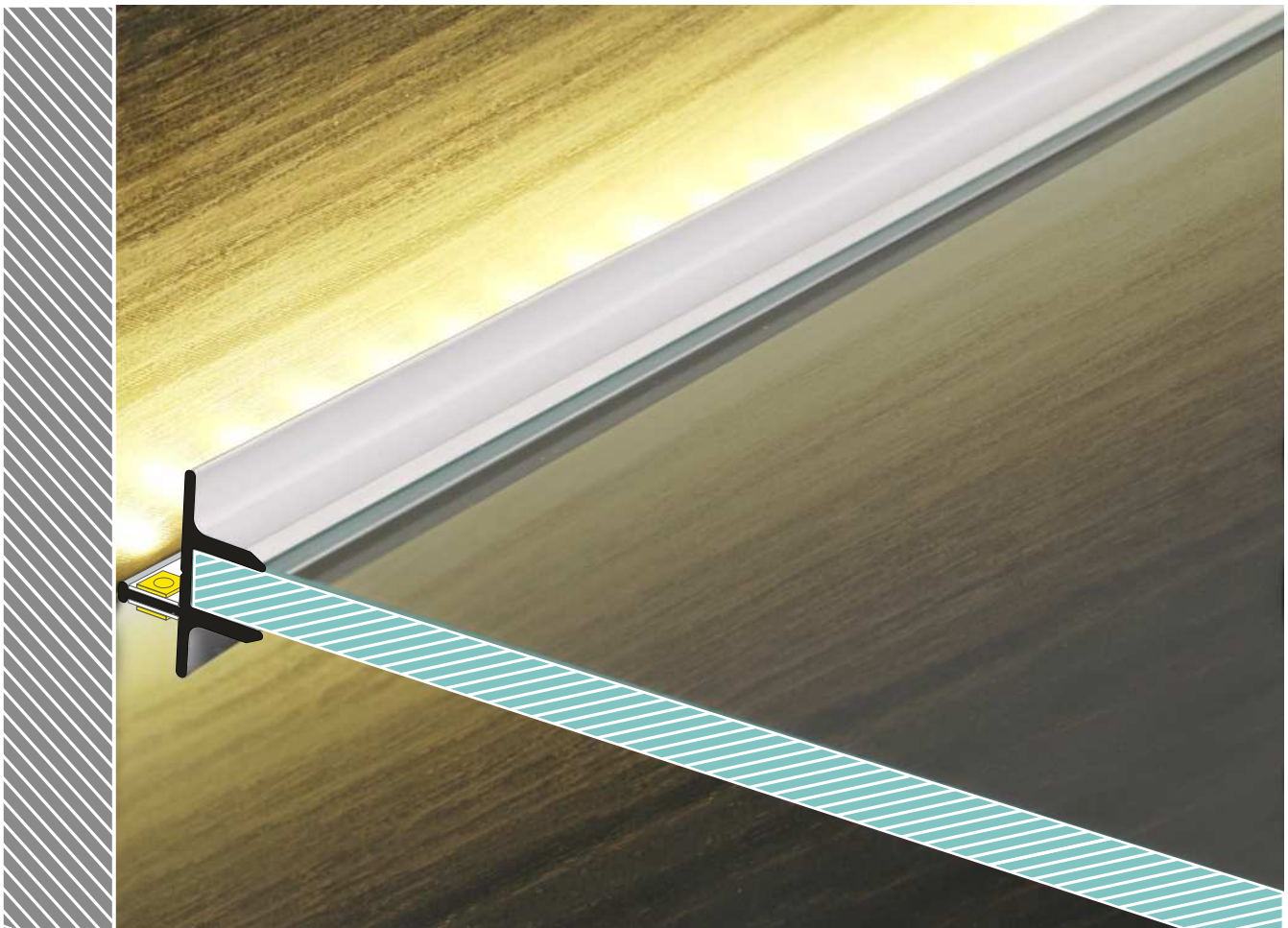

ÄHNLICHES IM ANGEBOT / SIMILAR IN THE OFFER



BACK10
A/UX



EDGE10
BC



MIKRO10



MIKRO-LINE12



CABI12
E

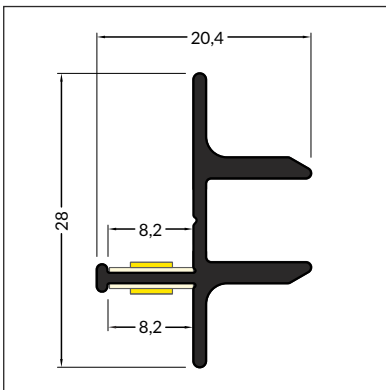

max 8 mm



Glaskantenprofile
glass application

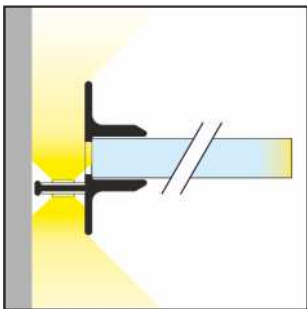
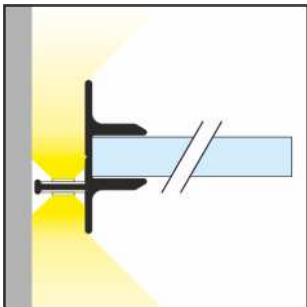
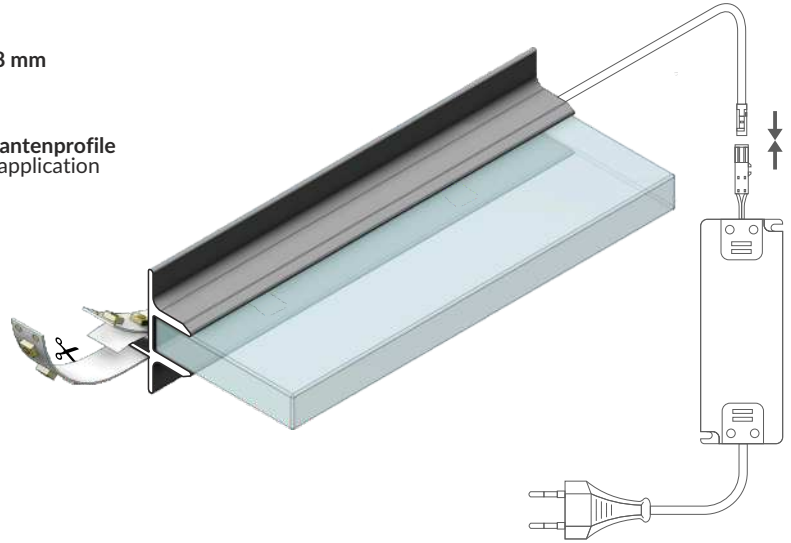

Artikelnummer = 1 Stück,
Länge 2.000 mm,
Verpackung > siehe bitte Preisliste
INDEX = 1 pc, length 2000 mm
package > check the pricelist

TWIN8
Rohaluminium
raw aluminium
82150000

TWIN8 PLUS
Rohaluminium
raw aluminium
82160000

Die zugänglichen Längen: 1000 mm, 2000 mm,
3000 mm, 4000 mm. Die standardmäßige Tole-
ranz der Länge von Profilen beträgt: +20 mm.
Mehr Informationen >> 1.08.

Available lengths: 1000 mm, 2000 mm,
3000 mm, 4000 mm. The standard profile length
tolerance is +20 mm.
More details >> 1.08.

WÄRMELEITBAND / THERMAL TAPE

Wärmeleitband 45 x 10 mm
doppelseitiges Klebeband

thermal tape 45 x 10 mm
self adhesive, double-sided

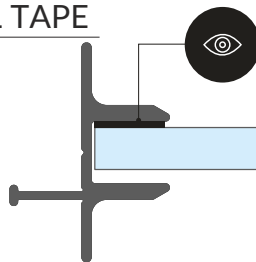

Artikelnummer = 1 Stück,
Verpackung > siehe bitte Preisliste
INDEX = 1 pc
package > check the pricelist

53820000



MIKRO10

EIN KLEINES GLASKANTENPROFIL

A SMALL EDGE PROFILE FOR GLASS PANELS

- für die Beleuchtung von Glaskanten oder der Gravur auf der Scheibenfläche
- geeignet hauptsächlich für Möbel (Vitrinen) und Werbebereich
- eine dezente Form
- geeignet für 6 mm Glasböden
- **Achtung: das Profil erfüllt keine Baufunktion**
- maximale Breite des LED Streifens 10 mm
- to illuminate the edge or engraving on the glass panel surface
- to be used for furniture (display cases) or advertising
- discreet form
- fits the 6 mm thick glass panel
- note: the profile is not a construction element
- maximum LED strip width: 10 mm

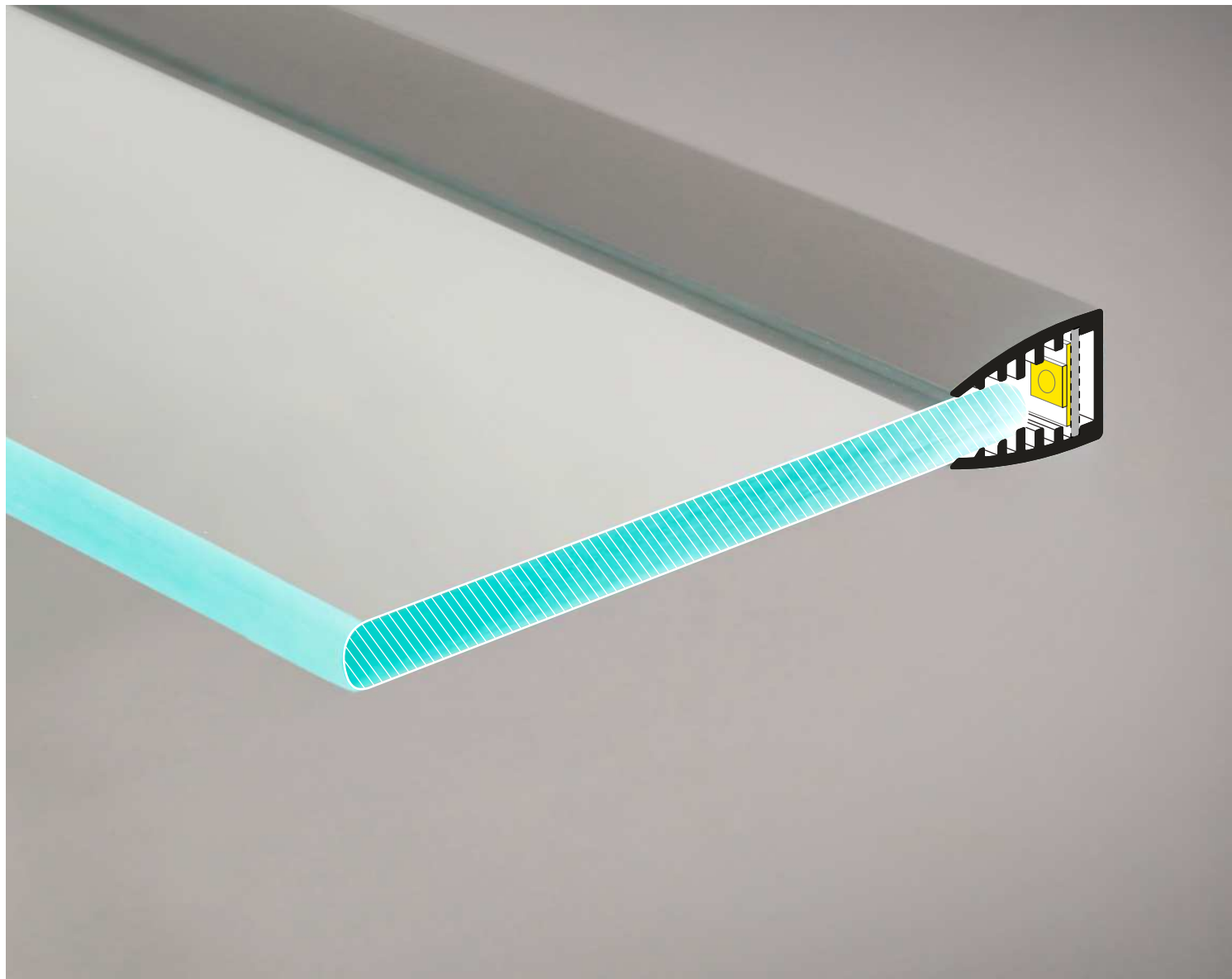

ÄHNLICHES IM ANGEBOT / SIMILAR IN THE OFFER



TWIN8



EDGE10
BC



MIKRO-LINE12



CABI12
E

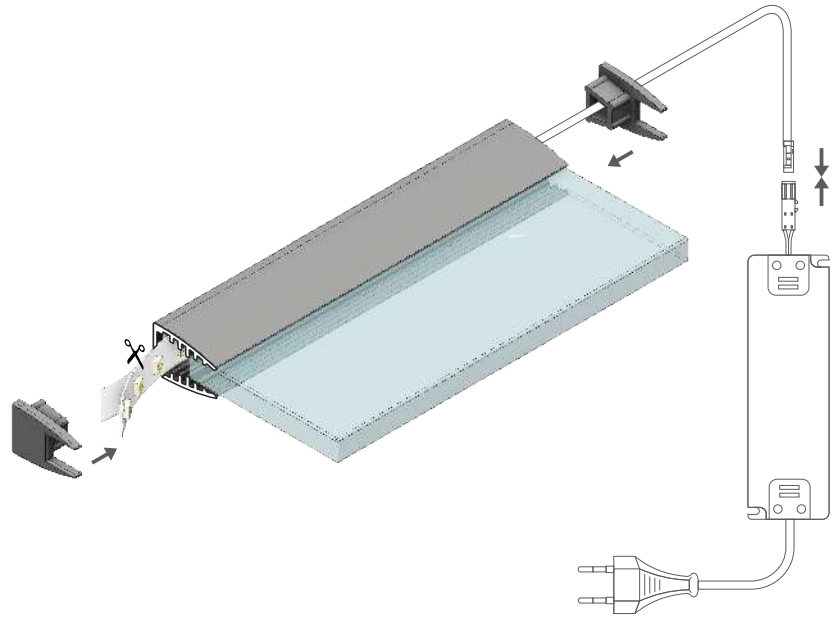
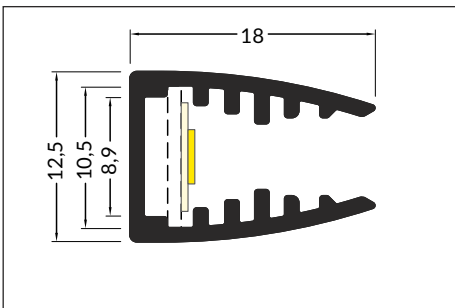
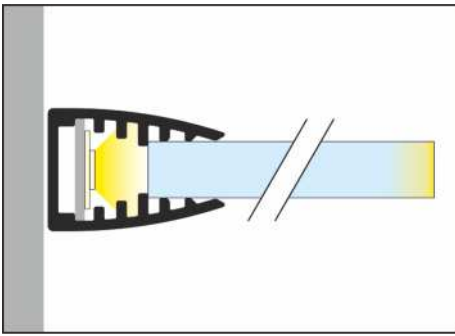

max 10 mm



Glaskantenprofile
glass application



Artikelnummer = 1 Stück,
Länge 2.000 mm,
Verpackung > siehe bitte Preisliste
INDEX = 1 pc, length 2000 mm
package > check the pricelist

eloxiert / anodized
68540020

Die zugänglichen Längen: 1000 mm, 2000 mm,
3000 mm, 4000 mm. Die standardmäßige Tole-
ranz der Länge von Profilen beträgt: +20 mm.
Mehr Informationen >> 1.08.

Available lengths: 1000 mm, 2000 mm,
3000 mm, 4000 mm. The standard profile length
tolerance is +20 mm.
More details >> 1.08.

ENDKAPPEN / ENDINGS

Endkappe MIKRO10

Farben: silbern, grau, transparent

Material: ABS, ABS, PC

MIKRO10 ending

colours: silver, grey, transparent

material: ABS, ABS, PC

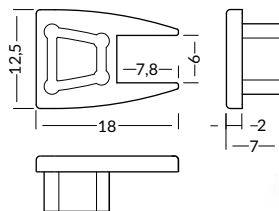

Artikelnummer = 10 Sets = 20 Stück
Verpackung > siehe bitte Preisliste
INDEX = 10 sets = 20 pcs
package > check the pricelist

silbern / silver
68550040

grau / grey
68550022

transparent
68550000

MONTAGETEIL FÜR LED / LED MOUNTING

Montageteil für LED MIKRO10

Material: HIPS

MIKRO10 LED mounting

material: HIPS

Artikelnummer = 1 Stück,
Länge 2.000 mm,
Verpackung > siehe bitte Preisliste
INDEX = 1 pc, length 2000 mm
package > check the pricelist

68640000

die zugänglichen Längen

Available lengths
1000 mm, 2000 mm

EDGE10 BC

DIE AUSFÜHRUNG DES RANDES UND BELUCHTUNG DER AUSSTELLUNG FINISHING EDGES AND LIGHTING OF DISPLAY WINDOWS

- es stellt den Rand fertig und stärkt es, bei einer Scheibe mit der Dicke von 8mm
 - es ermöglicht einen Rahmen um die Scheibe herum zu bauen
 - das Licht strahlt unter einem Winkel - es verursacht keine Blendung
 - die Beleuchtung von oben oder von unten
 - eine einfache Montage durch das Einkleben - unsichtbare Befestigung mit einem doppelseitigen Montageband
 - bei der Anwendung in einer dünneren Scheibe muss man ein zusätzliches Keilen oder Kleben mit einer Band voraussehen
 - maximale Breite des LED Streifens 10 mm
-
- the product for finishing and strengthening display window edges to a thickness up to 8 mm
 - suitable for decorative 'framing' of the display window
 - light is emitted at an angle - it does not cause glare
 - top or bottom illumination
 - easy installation - a double-sided tape not visible to customers
 - when using on a thinner glass, consider additional wedging or adhesive tape
 - maximum LED strip width: 10 mm



ÄHNLICHES IM ANGEBOT / SIMILAR IN THE OFFER



TWIN8



MIKRO10



MIKRO-LINE12



FRAME14
BC/Q



CABI12
E



- B** Abdeckung **B** einziehbar
B slide cover
- C** Abdeckung **C** einclipsbar
C click cover
- C** Abdeckung **C** einclipsbar Linse
C lens cover

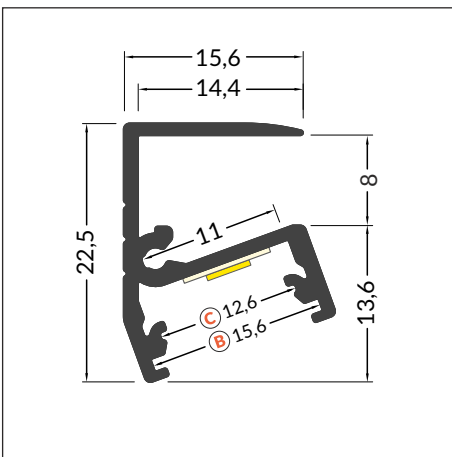
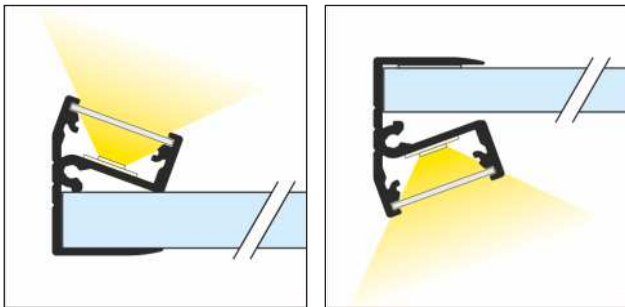
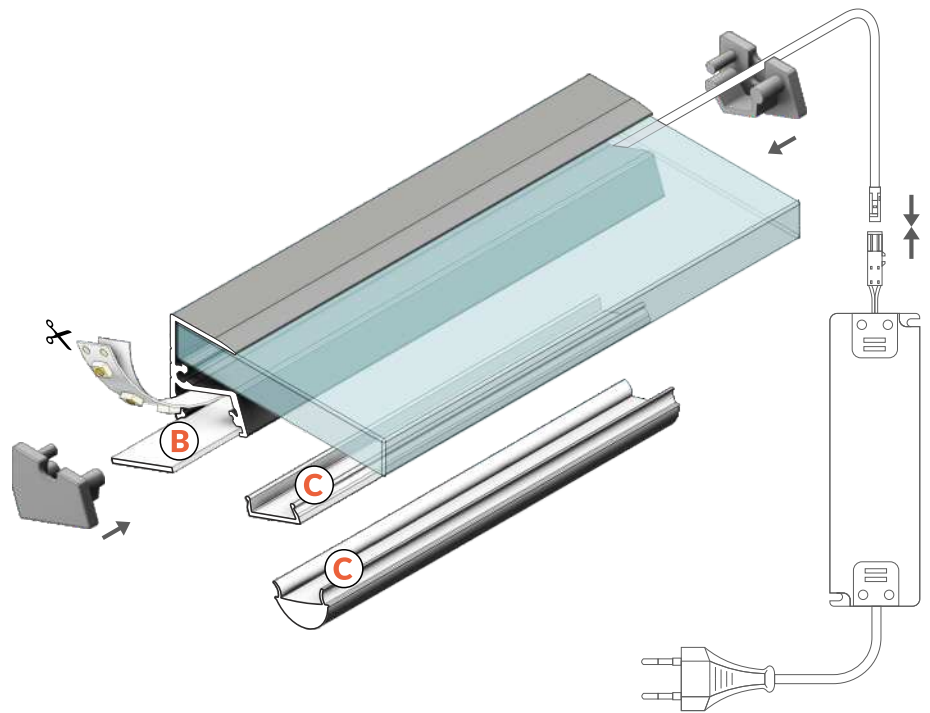

max 10 mm



Glaskantenprofile
glass application



Artikelnummer = 1 Stück,
Länge 2.000 mm,
Verpackung > siehe bitte Preisliste
INDEX = 1 pc, length 2000 mm
package > check the pricelist

weiß lackiert
white painted
A902001



eloxiert
anodized
A9020020



schwarz eloxiert
black anodized
A9020021



Rohaluminium
raw aluminium
A9020000

Die zugänglichen Längen: 1000 mm, 2000 mm, 3000 mm, 4000 mm.
Die standardmäßige Toleranz der Länge von Profilen beträgt: +20 mm.
Mehr Informationen >> 1.08.

Available lengths: 1000 mm, 2000 mm, 3000 mm, 4000 mm.
The standard profile length tolerance is +20 mm.
More details >> 1.08.



ABDECKUNG / COVERS

Abdeckung B einziehbar
Farben: transparent, satiniert, opal
Material: PC, PP, PP

B slide cover
colours: transparent, frosted, opal
material: PC, PP, PP



Achtung! Die Abmessungen des Platzes für die Montage von LED Lichtquelle
Note! Dimensions of the space to install LED source

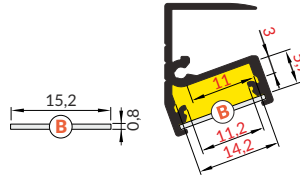

Länge 2.000 mm,
Verpackung > siehe bitte Preisliste
length 2000 mm
package > check the pricelist

B transparent
Artikelnummer = 10 Stück
index = 10 pcs
76250016



B satiniert / B frosted
Artikelnummer = 10 Stück
index = 10 pcs
76250039

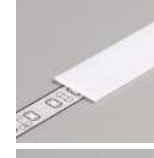

B opal
Artikelnummer = 10 Stück
index = 10 pcs
76250038



C transparent
Artikelnummer = 1 Stück
index = 1 pc
76330000



C opal
Artikelnummer = 1 Stück
index = 1 pc
76330038

Abdeckung C einclipsbar
Farben: transparent, opal
Material: PMMA

C click cover
colours: transparent, opal
material: PMMA

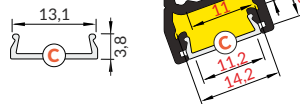

Rolle, Länge 20 m,
Verpackung > siehe bitte Preisliste
reel, length 20 m
package > check the pricelist

C opal
Artikelnummer = 1 Stück
index = 1 pc
76360038S

Abdeckung C einclipsbar Linse
Farbe: transparent
Material: PC

C lens click cover
colour: transparent
material: PC

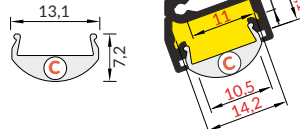

Länge 2.000 mm,
Verpackung > siehe bitte Preisliste
length 2000 mm
package > check the pricelist

C Linse / C lens
Artikelnummer = 1 Stück
index = 1 pc
76300000

Die Toleranz der Länge von Abdeckungen beträgt: +20 mm.
Mehr Informationen >> 1.08.
The standard cover length tolerance is +20 mm.
More details >> 1.08.

ENDKAPPEN / ENDINGS

Endkappe EDGE10 gen2 mit Öffnung
Farben: weiß, silbern, schwarz, grau
Material: ABS

EDGE10 ending gen2 with hole
colours: white, silver, black, grey
material: ABS

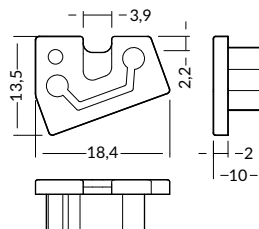

Artikelnummer = 10 Sets = 20 Stück
Verpackung > siehe bitte Preisliste
INDEX = 10 sets = 20 pcs
package > check the pricelist

weiß / white
A9950001
silbern / silver
A9950040
schwarz / black
A9950002
grau / grey
A9950022

WÄRMELEITBAND / THERMAL TAPE

Wärmeleitband 45 x 10 mm
doppelseitiges Klebeband

thermal tape 45 x 10 mm
self adhesive, double-sided

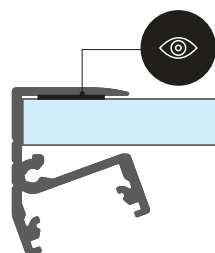

Artikelnummer = 1 Stück,
Verpackung > siehe bitte Preisliste
INDEX = 1 pc
package > check the pricelist

53820000



Abhängig von der Montage-
weise gibt das Profil EDGE10
die Möglichkeit der Beleuch-
tung der Ausstellung
von oben oder von unten.

Depending on the installation
method, EDGE10 profile may
illuminate the display area
from the top or from below.



MIKRO-LINE12 J

EIN GLASKANTENPROFIL

EDGE PROFILE FOR GLASS PANELS

- dekorative Beleuchtung
- es beleuchtet eine Kante oder die Gravur auf der Scheibenfläche
- hauptsächlich für die Anwendung in Möbel und Werbung
- geeignet für 8mm Glasböden
- Achtung: das Profil erfüllt keine Baufunktion
- maximale Breite des LED Streifens 12 mm

- decorative illumination
- illuminates the edge or engraving on the glass panel surface
- for furniture and advertisement use mainly
- fits the 8 mm glass panels
- note: the profile is not a construction element
- maximum LED strip width: 12 mm

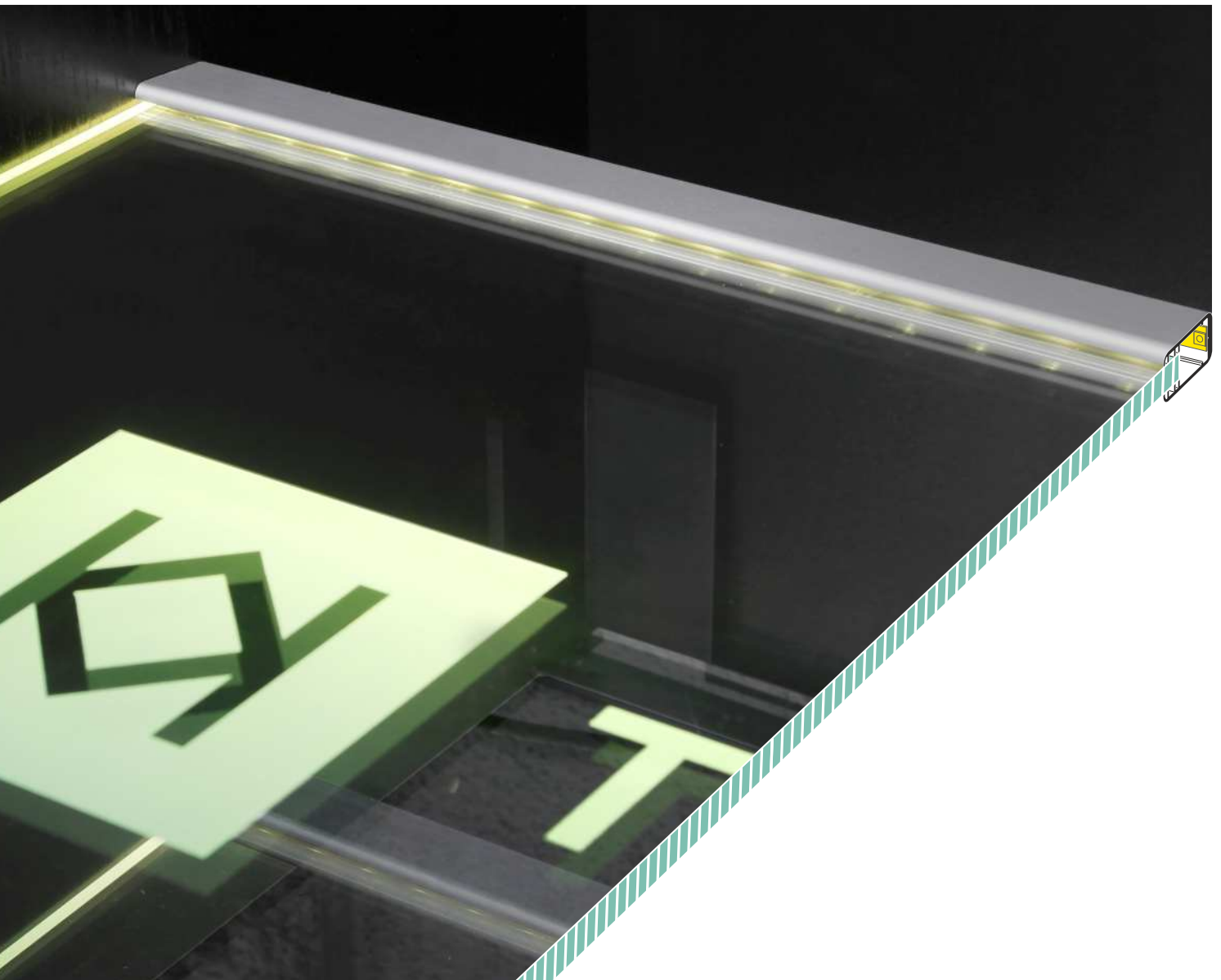

ÄHNLICHES IM ANGEBOT / SIMILAR IN THE OFFER



TWIN8



EDGE10
BC



MIKRO10



CABI12
E

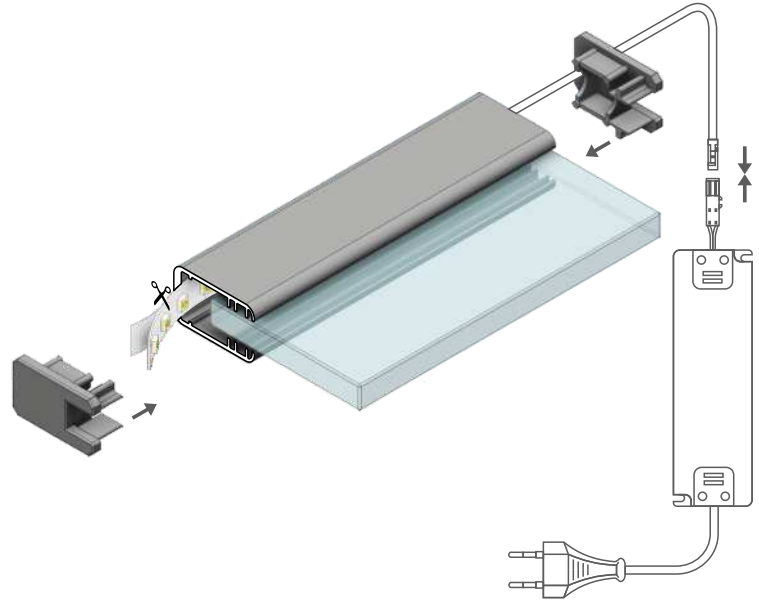
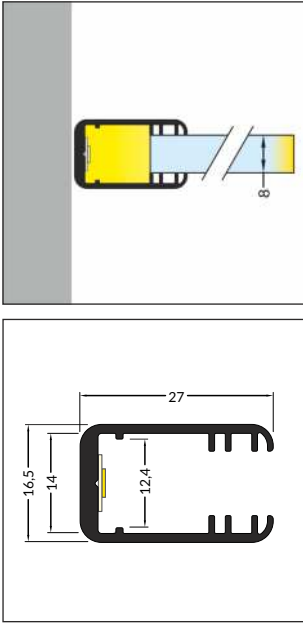

max 12 mm



Glaskantenprofile
glass application



Auf Lager verfügbar
available in stock



Artikelnummer = 1 Stück,
Länge 2.000 mm,
Verpackung > siehe bitte Preisliste
INDEX = 1 pc, length 2000 mm
package > check the pricelist

eloxiert
anodized

70280020

Rohaluminium
raw aluminium

70280000

Die zugänglichen Längen: 1000 mm, 2000 mm,
3000 mm, 4000 mm. Die standardmäßige Toleranz
der Länge von Profilen beträgt: +20 mm.
Mehr Informationen >> 1.08.

Available lengths: 1000 mm, 2000 mm, 3000 mm,
4000 mm. The standard profile length tolerance
is +20 mm. More details >> 1.08.

ENDKAPPEN / ENDINGS

Endkappe MIKRO-LINE12

Farben: silbern, grau, transparent

Material: ABS, ABS, PC

MIKRO-LINE12 ending

colours: silver, grey, transparent

material: ABS, ABS, PC

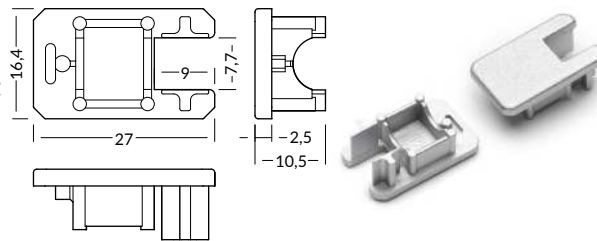

Artikelnummer = 10 Sets = 20 Stück
Verpackung > siehe bitte Preisliste
INDEX = 10 sets = 20 pcs
package > check the pricelist

silbern / silver
70290040

grau / grey
70290022

transparent
70290000



Achtung! Die Abmessungen des Platzes für die Montage von LED Lichtquelle
Note! Dimensions of the space to install LED source

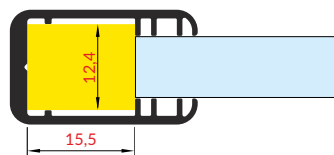

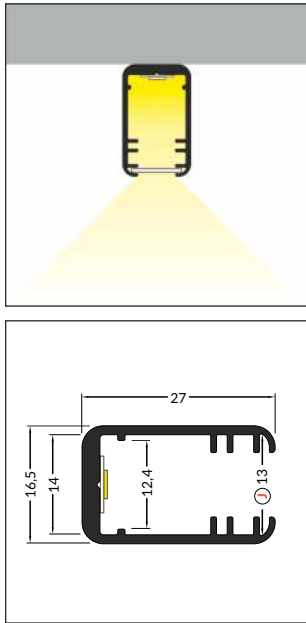

J Abdeckung **J** einschiebbar
J slide cover

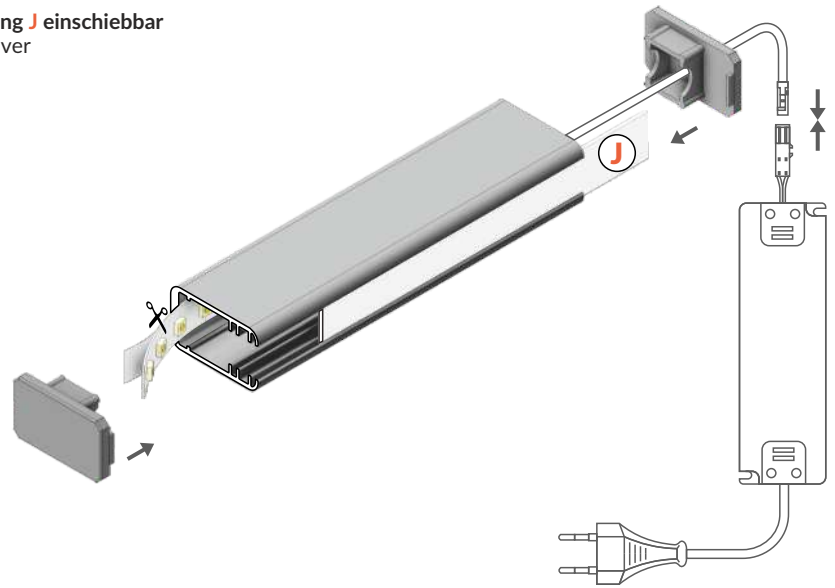

max 12 mm

Glaskantenprofile
 special application

Auf Lager verfügbar
 available in stock



Artikelnummer = 1 Stück,
 Länge 2.000 mm,
 Verpackung > siehe bitte Preisliste
 INDEX = 1 pc, length 2000 mm
 package > check the pricelist

eloxiert
 anodized
70280020

Rohaluminium
 raw aluminium
70280000

Die zugänglichen Längen: 1000 mm, 2000 mm, 3000 mm, 4000 mm. Die standardmäßige Toleranz der Länge von Profilen beträgt: +20 mm. Mehr Informationen >> 1.08.
 Available lengths: 1000 mm, 2000 mm, 3000 mm, 4000 mm. The standard profile length tolerance is +20 mm. More details >> 1.08.

ENDKAPPEN / ENDINGS

Endkappe MIKRO-LINE12 LINIA
 Farben: silbern, grau, transparent
 Material: ABS, ABS, PC
 MIKRO-LINE12 LINIA ending
 colours: silver, grey, transparent
 material: ABS, ABS, PC

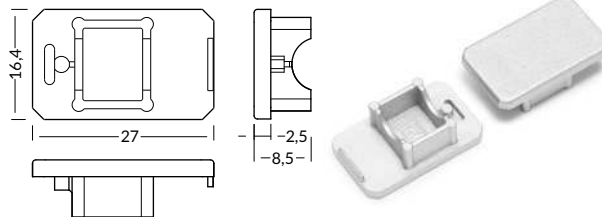

Artikelnummer = 10 Sets = 20 Stück
 Verpackung > siehe bitte Preisliste
 INDEX = 10 sets = 20 pcs
 package > check the pricelist

silbern / silver
70300040

grau / grey
70300022

transparent
70300000

ABDECKUNG / COVERS

Abdeckung **J** einschiebbar
 Farben: transparent, satiniert, opal
 Material: PC, PP, PP

J slide cover
 colours: transparent, frosted, opal
 material: PC, PP, PP

Achtung! Die Abmessungen des Platzes für die Montage von LED Lichtquelle
Note! Dimensions of the space to install LED source

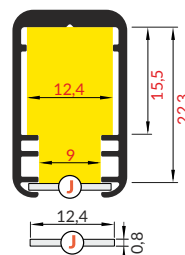

Länge 2.000 mm,
 Verpackung > siehe bitte Preisliste
 length 2000 mm
 package > check the pricelist

J transparent
 Artikelnummer = 10 Stück
 indeks = 10 pcs
70330016

J satiniert / **J** frosted
 Artikelnummer = 10 Stück
 indeks = 10 pcs
70330039

J opal
 Artikelnummer = 10 Stück
 indeks = 10 pcs
70330038

Die Toleranz der Länge von Abdeckungen beträgt: +20 mm.
 Mehr Informationen >> 1.08.
 The standard cover length tolerance is +20 mm.
 More details >> 1.08.

**DIE ANWENDUNG DES PROFILS:
PROFILE APPLICATION:**

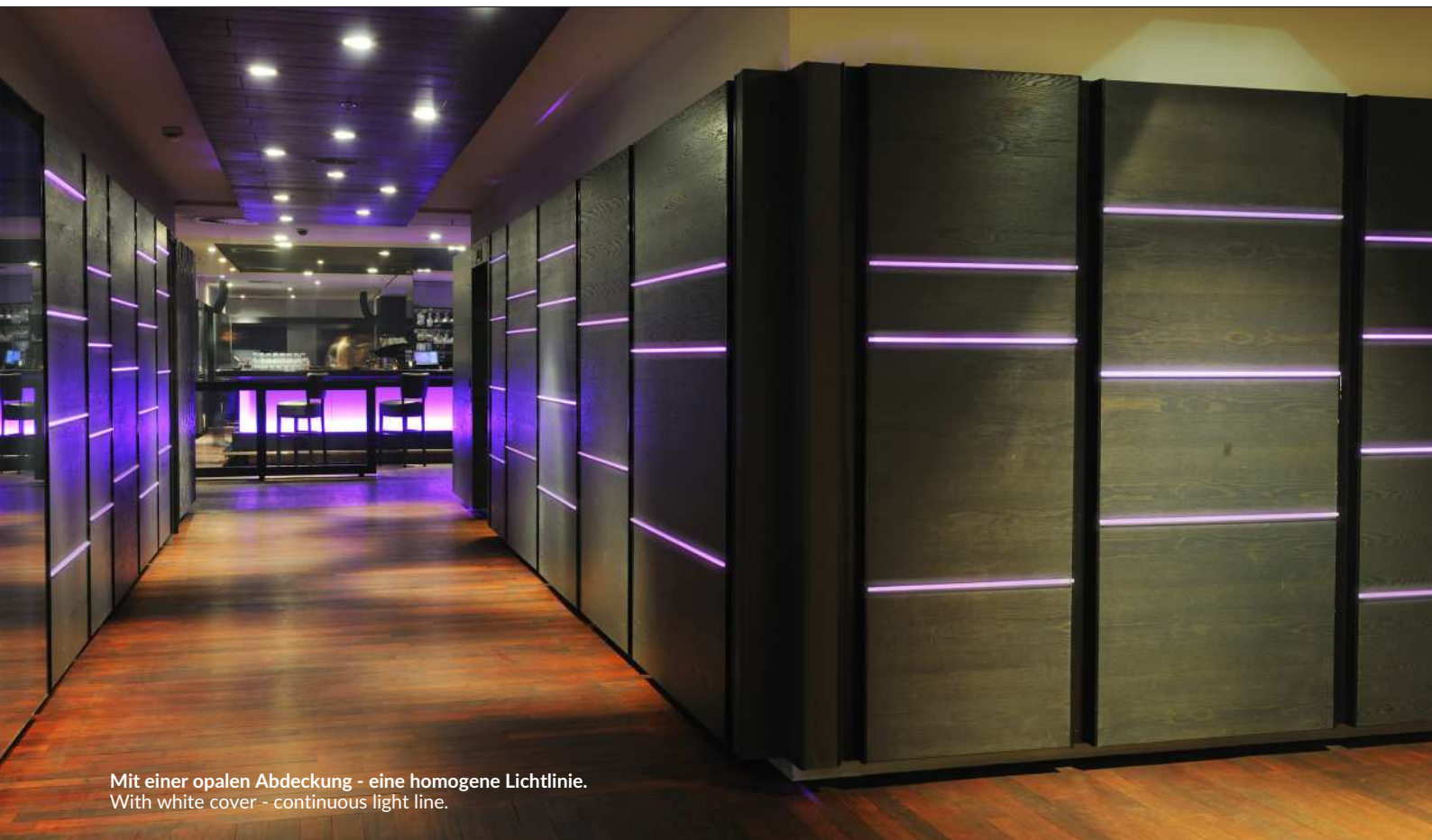

Mit einer opalen Abdeckung - eine homogene Lichtlinie.
With white cover - continuous light line.



Mit einer Scheibe - die Beleuchtung der sandgestrahlten Kante.
With glass panel - illumination of sandblasted edge.



2020

LED PROFILE
LED PROFILES

VARIO30 / VARIO30

30



SYSTEM VON LICHTVARIATIONEN

VARIOUS LIGHT IDEAS

- 18 Varianten und Kombinationen
- von Hänge- bis zu Einbauversionen
- Gehäuse um die Energieversorgung
- eine Lichtlinie in Eckverbindern
- unbegrenzte Möglichkeiten der Lichtgestaltung

- 18 variations and combinations
- from pendant to recessed
- housing around the powering supply
- continuous light line in angular connections
- unlimited possibilities in creating light

Beispiel / an example
variant 18

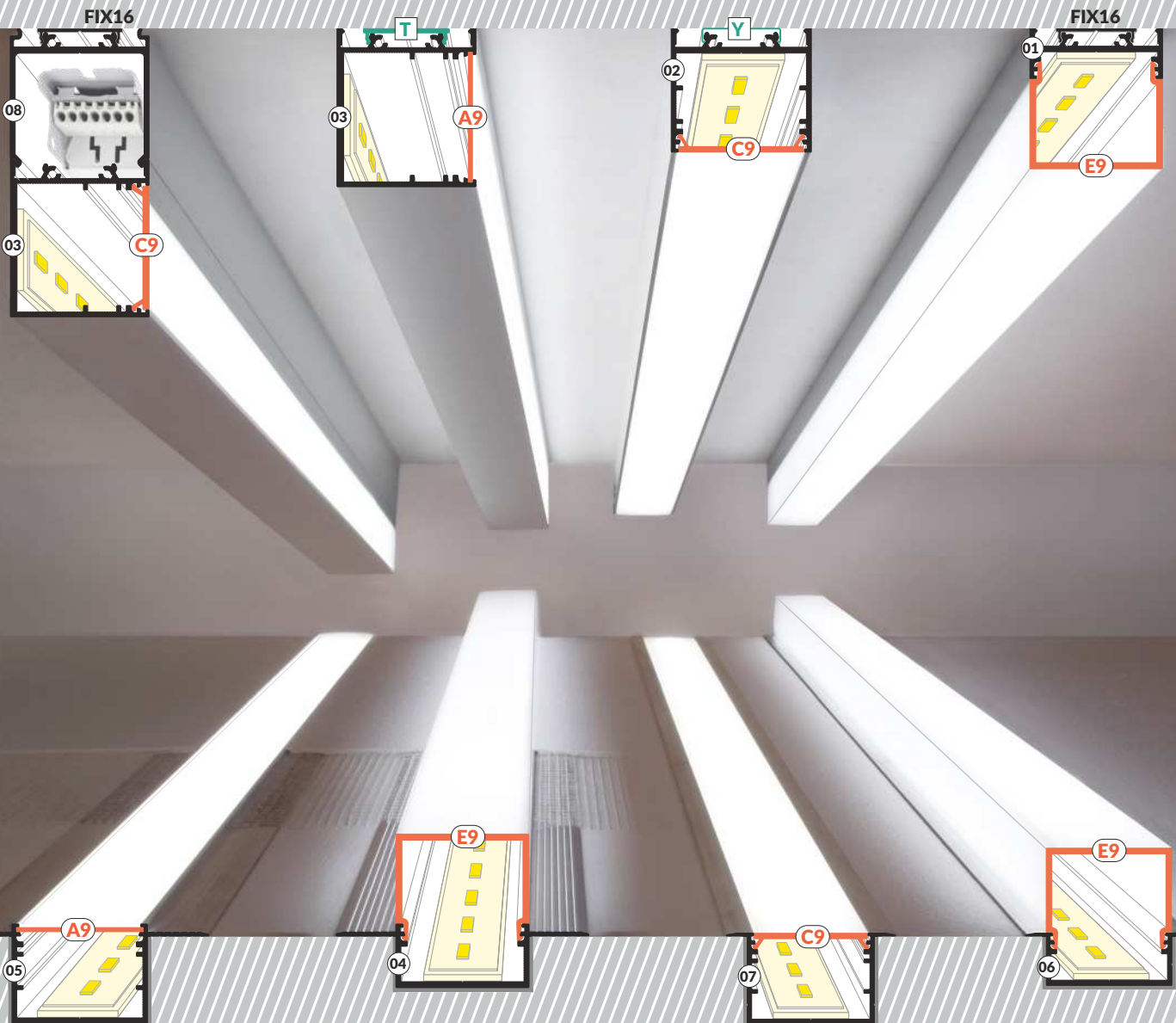
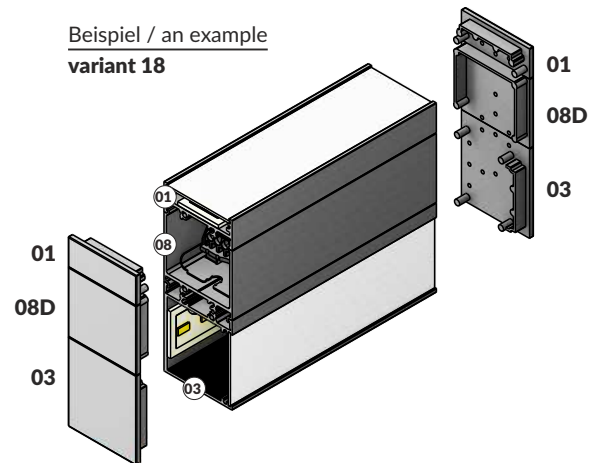

EMPFOHLENE VARIANTEN PROMOTED VARIANTS

Variante 27 - Hängeversion 09-08-02-C9
variant 27 - pendant 09-08-02-C9

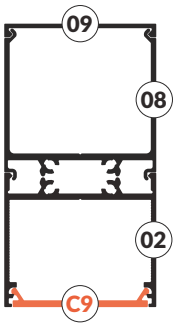

Variante 15 - Deckenversion FIX16-08-01-E9
variant 15 - ceiling FIX16-08-01-E9

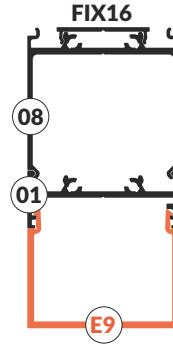

Variante 32 - seitliche Wandversion FIX16-08-03-A9
variant 32 - wall side FIX16-08-03-A9

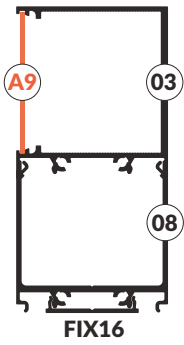

Variante 11 - Möbelversion FIX16-01-C9
variant 11 - furniture FIX16-01-C9

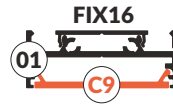

Variante 06 - Einbauversion 06-E9
variant 06 - recessed 06-E9

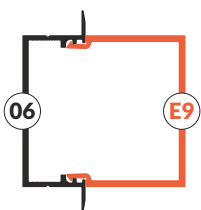

Variante 05 - Einbauversion 05-A9 zum Verputzen
variant 05 - recessed 05-A9 spackle flange

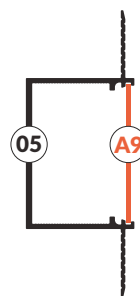

EMPFOHLENE VARIANTEN PROMOTED VARIANTS

BASISVARIANTEN / BASIC VARIANTS

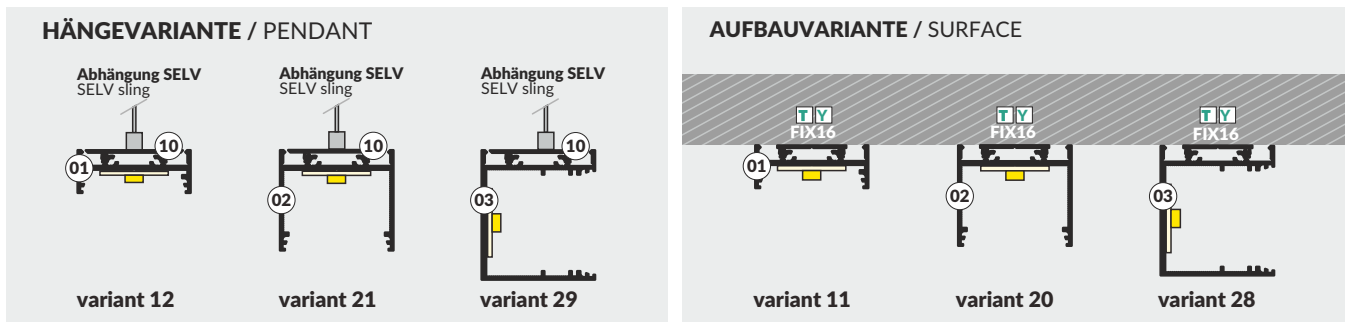

DIE VARIANTEN MIT DEM NETZTEILGEHÄUSE / VARIANTS WITH POWER SUPPLY COVER

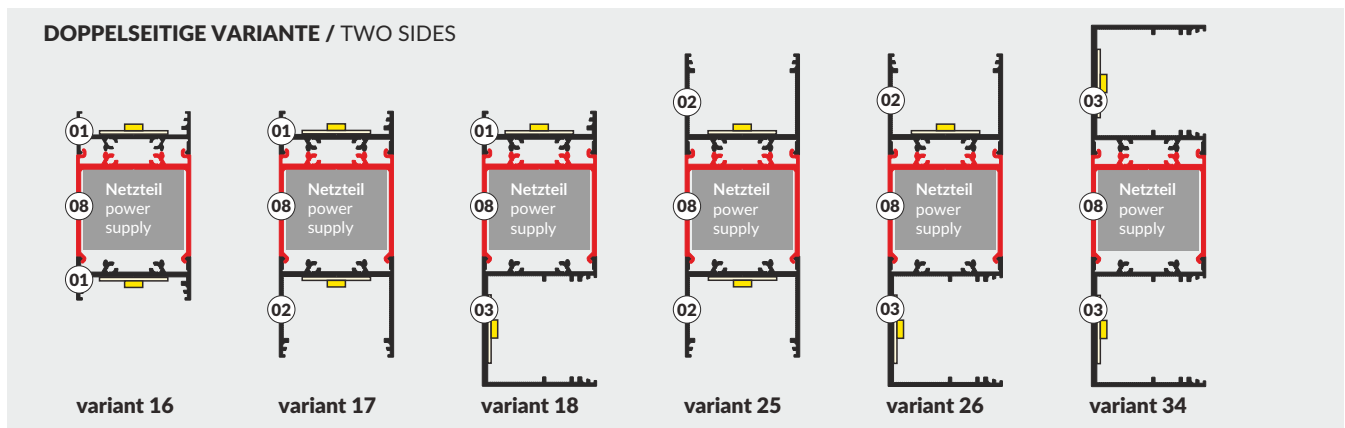
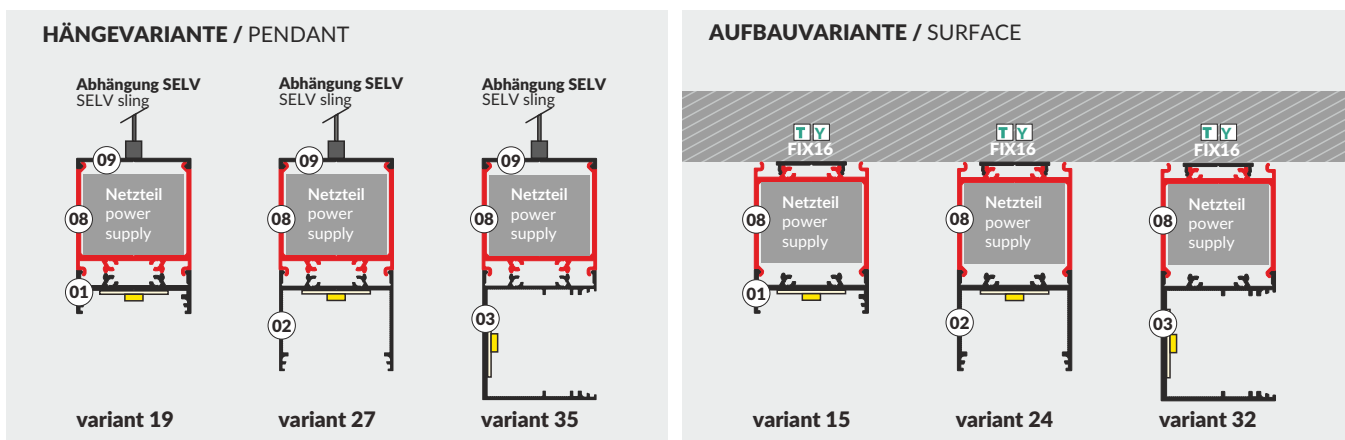

EINBAUVARIANTEN / RECESSED VARIANTS

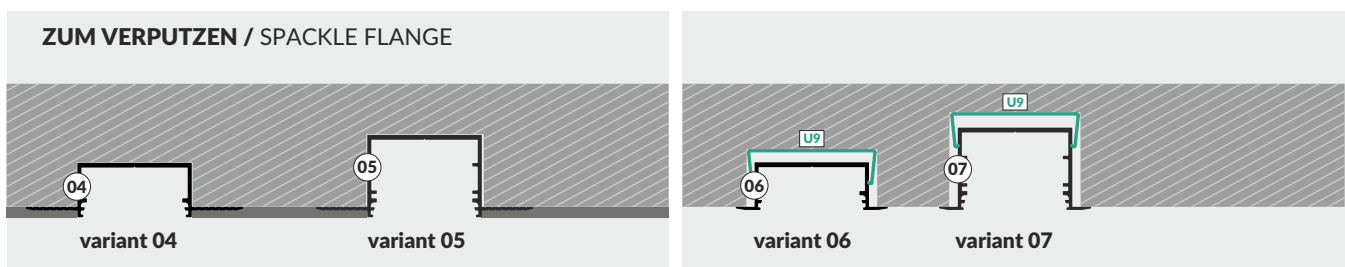

VARIO30

AUFBAUPROFILE / SURFACE

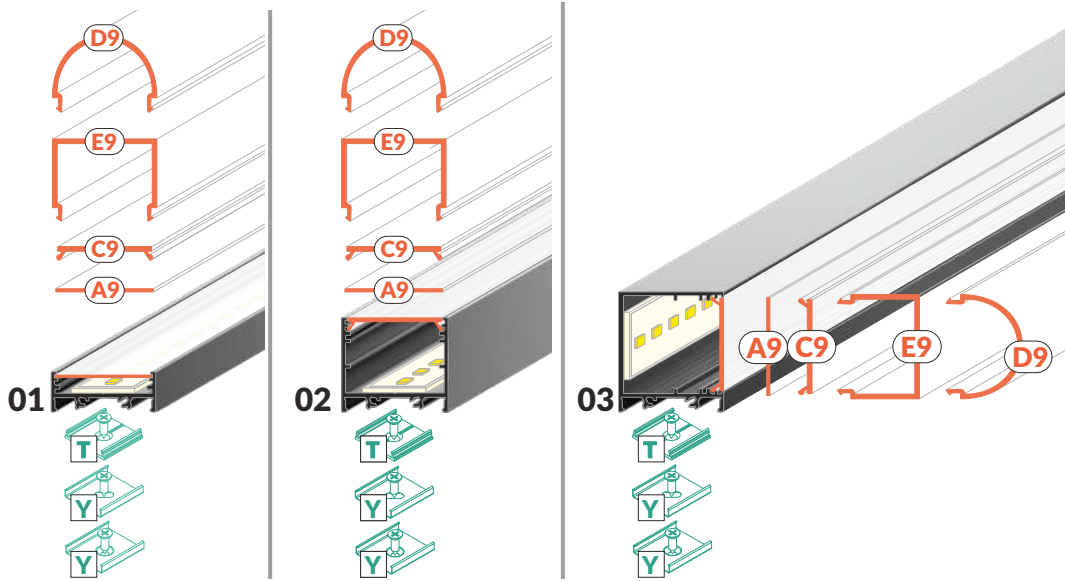

NETZTEILGEHÄUSE POWER SUPPLY COVER

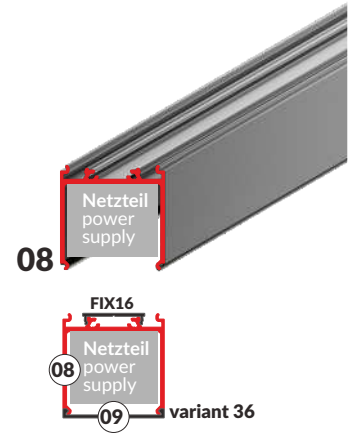

HILFSPROFILE / ASSISTANT PROFILES

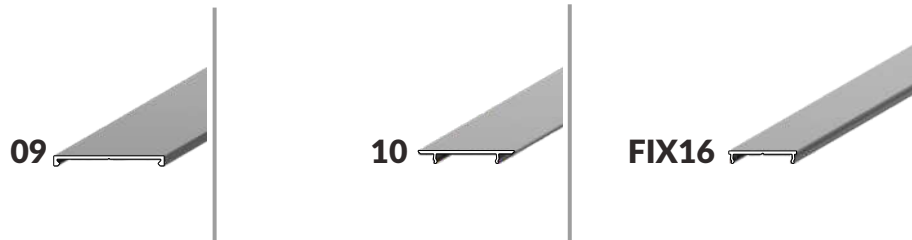

EINABUPROFILE ZUM VERPUTZEN RECESSED SPACKLE FLANGE

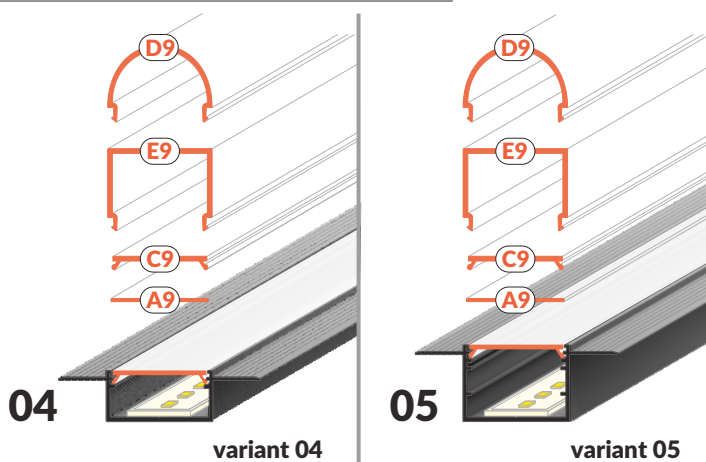

EINABUPROFILE RECESSED

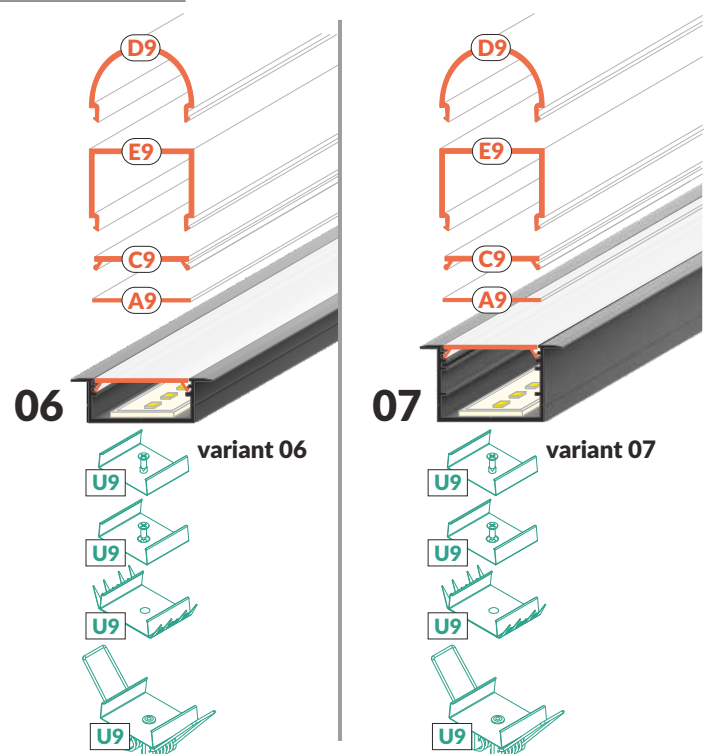

AUFBAUPROFILE SURFACE PROFILES



VARIO30-01 > 7.06
VARIO30-02 > 7.06
VARIO30-03 > 7.06
VARIO30-08 > 7.06

VARIO30-09 > 7.07
VARIO30-10 > 7.07
FIX16 > 7.07

Halter / mountings > 7.08
Endkappen / endings > 7.09
Verbindungsstücke / connectors > 7.12

Abdeckungen / diffusers > 7.18
übrige / others > 7.22

AUFBAUPROFILE, ENERGIEVERSORGUNGSGEHÄUSE

SURFACE, POWER SUPPLY COVER

Auf Lager verfügbar
Available in stock



LED Profil / LED profile VARIO30-01

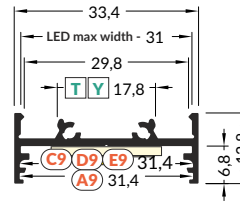
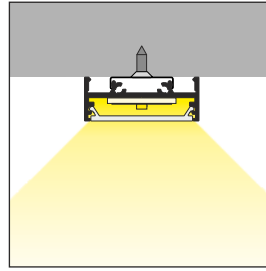

weiß	eloxiert	schwarz eloxiert	Rohaluminium
white	anodized	black anodized	raw
V3020001	V3020020	V3020021	V3020000

Artikelnummer = 1 Stück, Länge 2.000 mm, Verpackung > siehe bitte Preisliste
INDEX = 1 pc, length 2000 mm, package > check the pricelist

LED Profil / LED profile VARIO30-02

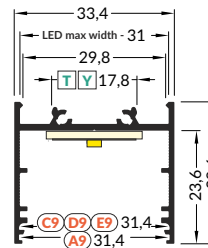
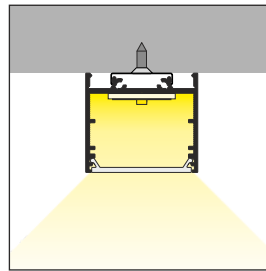

weiß	eloxiert	schwarz eloxiert	Rohaluminium
white	anodized	black anodized	raw
V3060001	V3060020	V3060021	V3060000

Artikelnummer = 1 Stück, Länge 2.000 mm, Verpackung > siehe bitte Preisliste
INDEX = 1 pc, length 2000 mm, package > check the pricelist

LED Profil / LED profile VARIO30-03

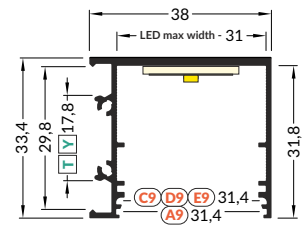
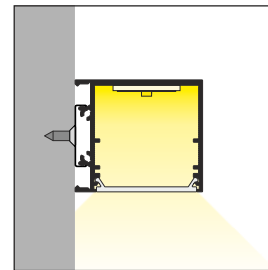
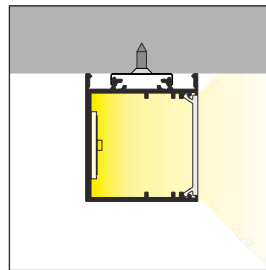

weiß	eloxiert	schwarz eloxiert	Rohaluminium
white	anodized	black anodized	raw
V3100001	V3100020	V3100021	V3100000

Artikelnummer = 1 Stück, Länge 2.000 mm, Verpackung > siehe bitte Preisliste
INDEX = 1 pc, length 2000 mm, package > check the pricelist

Einspeisungsprofil / power supply profile VARIO30-08

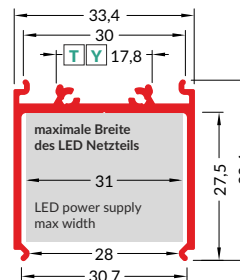
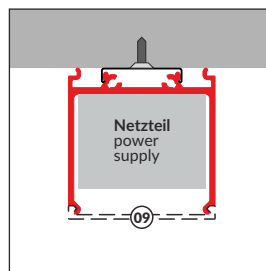

weiß	eloxiert	schwarz eloxiert	Rohaluminium
white	anodized	black anodized	raw
V3300001	V3300020	V3300021	V3300000

Artikelnummer = 1 Stück, Länge 2.000 mm, Verpackung > siehe bitte Preisliste
INDEX = 1 pc, length 2000 mm, package > check the pricelist

Die zugänglichen Längen: 1000 mm, 2000 mm, 3000 mm, 4000 mm. Die standardmäßige Toleranz der Länge von Profilen beträgt: +20 mm. Mehr Informationen >>1.08.
Available lengths: 1000 mm, 2000 mm, 3000 mm, 4000 mm. The standard profile length tolerance is +20 mm. More details >> 1.08.



Aluminiumabdeckplatte / cover VARIO30-09

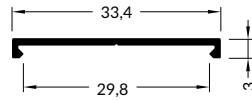

weiß	eloxiert	schwarz eloxiert	Rohaluminium
white	anodized	black anodized	raw
V3340001	V3340020	V3340021	V3340000

Artikelnummer = 1 Stück, Länge 2.000 mm, Verpackung > siehe bitte Preisliste
INDEX = 1 pc, length 2000 mm, package > check the pricelist

Aluminiumabdeckplatte / cover VARIO30-10

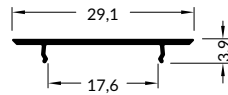

weiß	eloxiert	schwarz eloxiert	Rohaluminium
white	anodized	black anodized	raw
V3380001	V3380020	V3380021	V3380000

Artikelnummer = 1 Stück, Länge 2.000 mm, Verpackung > siehe bitte Preisliste
INDEX = 1 pc, length 2000 mm, package > check the pricelist

LED Profile / LED profile FIX16

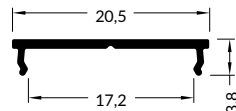

weiß	eloxiert	schwarz eloxiert	Rohaluminium
white	anodized	black anodized	raw
C6020001	C6020020	C6020021	C6020000

Artikelnummer = 1 Stück, Länge 2.000 mm, Verpackung > siehe bitte Preisliste
INDEX = 1 pc, length 2000 mm, package > check the pricelist



Halter Y flexibel Y flexible mounting plate

Material: rostfreier Stahl
material: stainless steel

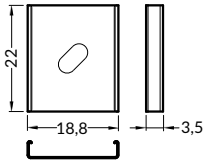

Halter Y flexibel cone cone Y flexible mounting plate

Material: rostfreier Stahl
material: stainless steel

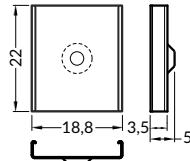

Halter T T mounting plate

Material: Aluminium
material: aluminium

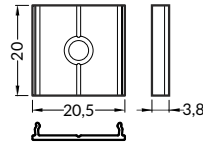

Gelenkhalter tilted bracket

Material: rostfreier Stahl, Kunststoff
material: stainless steel, plastic

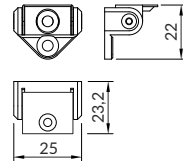

für einen Satz soll man
die flexiblen Y Halter cone
zusätzlich kaufen
please note you need
the Y mounting plate
that is not included

Halter	inox	Rohaluminium		
mountings	inox	raw aluminium		
Halter Y flexibel / Y flexible mounting plate	A2090019	-		
Halter Y flexibel cone / cone Y flexible mounting plate	A2130019	-		
Halter T / T mounting plate	-	C6960000		
	weiß	silbern	schwarz	grau
	white	silver	black	grey
Gelenkhalter / tilted bracket	67230001	67230040	67230002	67230022

Artikelnummer = 10 Sets = 20 Stück, Verpackung > siehe bitte Preisliste / INDEX = 10 sets = 20 pcs, package > check the pricelist

BEZEICHNUNG DER ENDKAPPEN ENDINGS KNOW HOW

Auf Lager verfügbar
Available in stock



Abdeckung / Abdeckprofil / Profil
diffuser / cover / profile

die für das Profil 08 vorgesehene Endkappe
ending dedicated to VARIO30-08 profile

der untere Teil des LED Profils
bottom of the LED profile

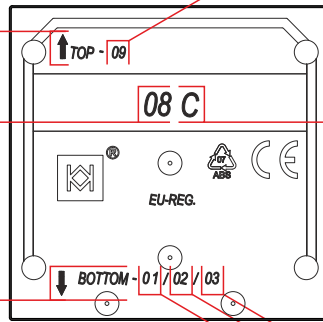

Die Name der Profile, die mit einer gewählten Endkappe zusammenpassen:
- Abdeckprofil VARIO30-09

names of profiles fitting with chosen ending:
- VARIO30-09 cover

Variantentyp
type of variant

die Namen der Profile für eine gewählte Endkappe
- LED Profil VARIO30-01
- LED Profil VARIO30-02
- LED Profil VARIO30-03

names of profiles fitting with chosen ending:
- LED profile VARIO30-01
- LED profile VARIO30-02
- LED profile VARIO30-03

Beispiel / an example
VARIANT 18

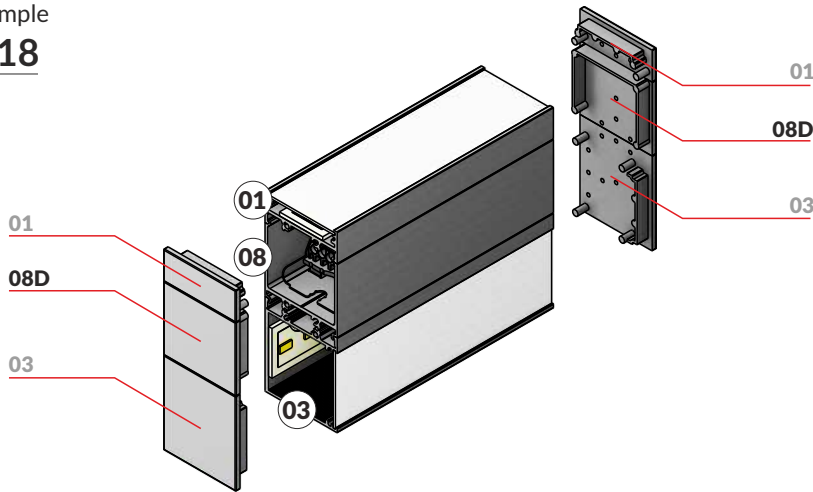

ENDKAPPEN / ENDINGS

Material: ABS

material: ABS

Endkappe VARIO30-01
VARIO30-01 ending

Endkappe VARIO30-02
VARIO30-02 ending

Endkappe VARIO30-03
VARIO30-03 ending

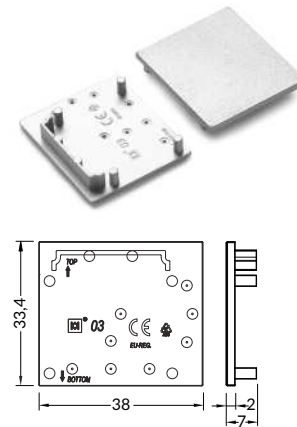
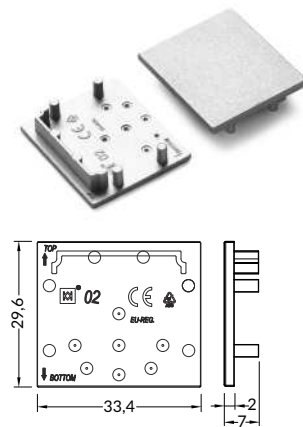
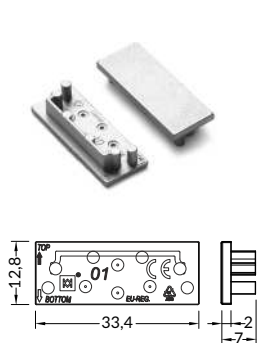

die Endkappe für die Profile
ending for profile

weiß
white

silbern
silver

schwarz
black

grau
grey

VARIO30-01

V4870001

V4870040

V4870002

V4870022

VARIO30-02

V4880001

V4880040

V4880002

V4880022

VARIO30-03

V4890001

V4890040

V4890002

V4890022

Artikelnummer = 10 Sets = 20 Stück, Verpackung > siehe bitte Preisliste / INDEX = 10 sets = 20 pcs, package > check the pricelist



Endkappe VARIO30-08A / VARIO30-08A ending

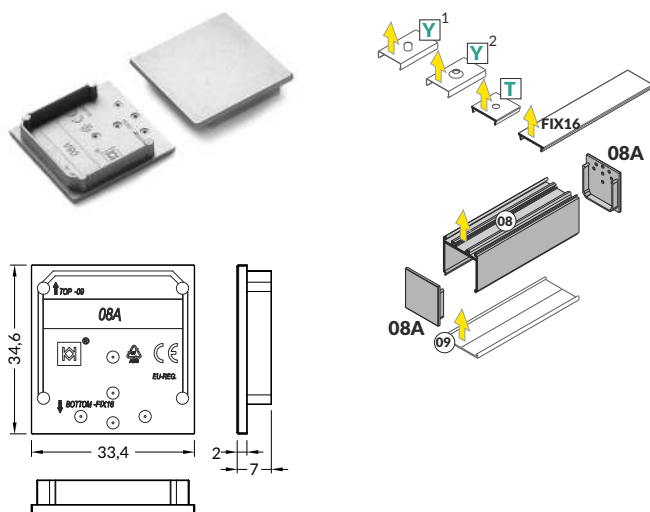

Endkappe VARIO30-08B / VARIO30-08B ending

Für Varianten: 15, 24, 32 / For variants: 15, 24, 32

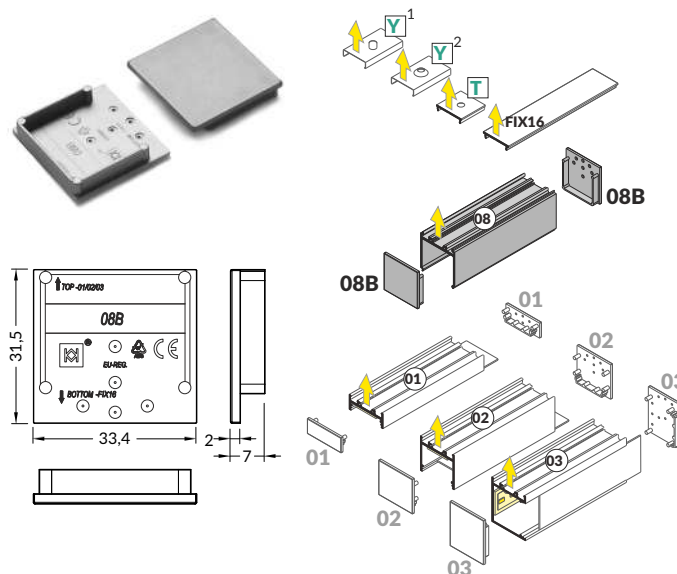

Endkappe VARIO30-08C / VARIO30-08C ending

Für Varianten: 19, 27, 35 / For variants: 19, 27, 35

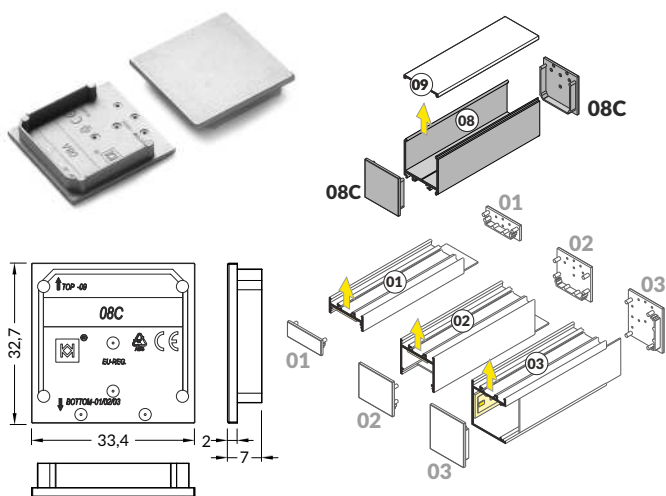

Endkappe VARIO30-08D / VARIO30-08D ending

Für Varianten: 16, 17, 18, 25, 26, 34 / For variants: 16, 17, 18, 25, 26, 34

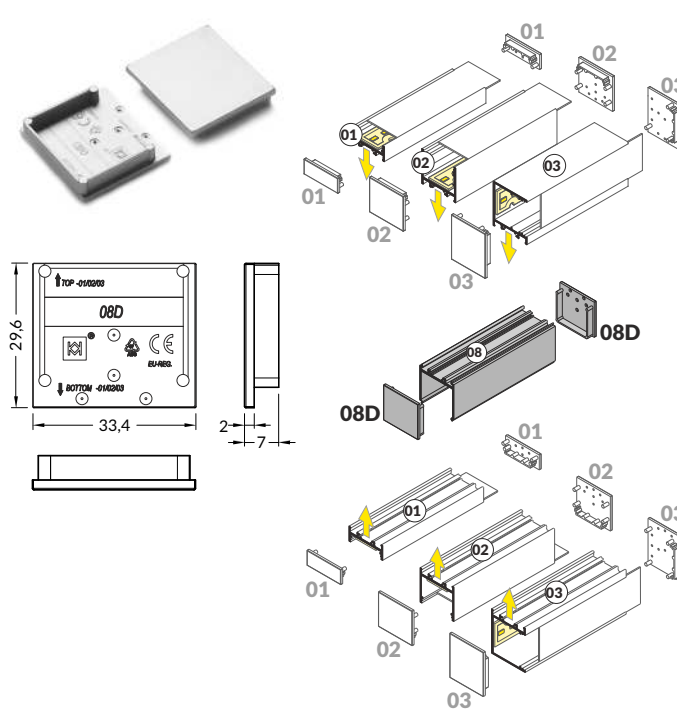

die Endkappe für die Profile
ending for profile

weiß
white

silber
silver

schwarz
black

grau
grey

VARIO30-08ABCD

V4600001

V4600040

V4600002

V4600022

Artikelnummer = 1 Set = 2 x 08A + 2 x 08B + 2 x 08C + 2x08D, Verpackung > siehe bitte Preisliste / INDEX = 1 set = 2 x 08A + 2 x 08B + 2 x 08C + 2x08D, package > check the pricelist



Endkappe VARIO30-16-E9 aus Metall / VARIO30-16-E9 metal ending

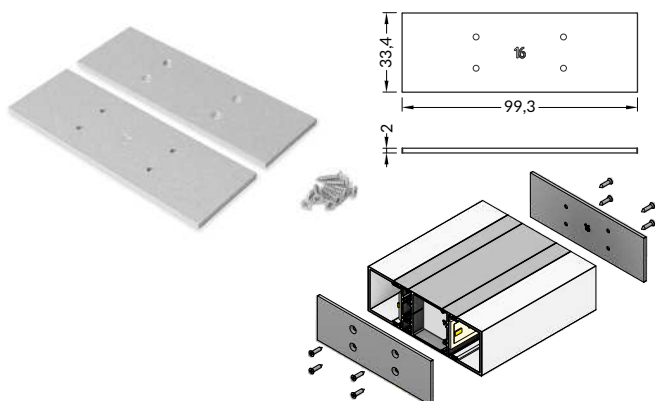

Endkappe VARIO30-19-E9 aus Metall / VARIO30-19-E9 metal ending

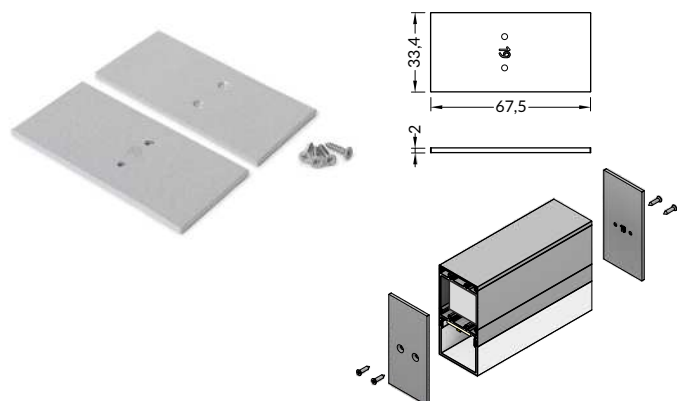

Endkappe VARIO30-27 aus Metall / VARIO30-27 metal ending

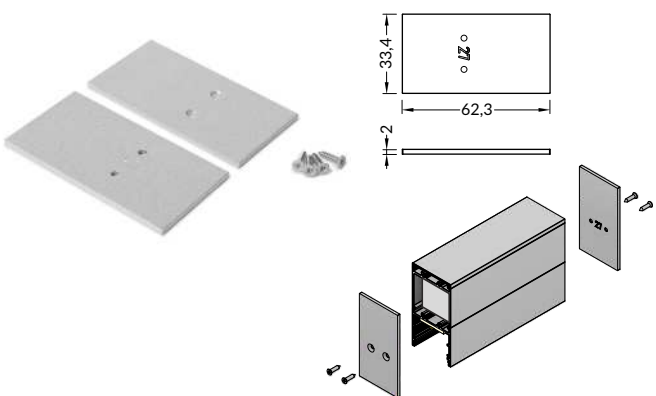

Endkappe VARIO30-32 aus Metall / VARIO30-32 metal ending

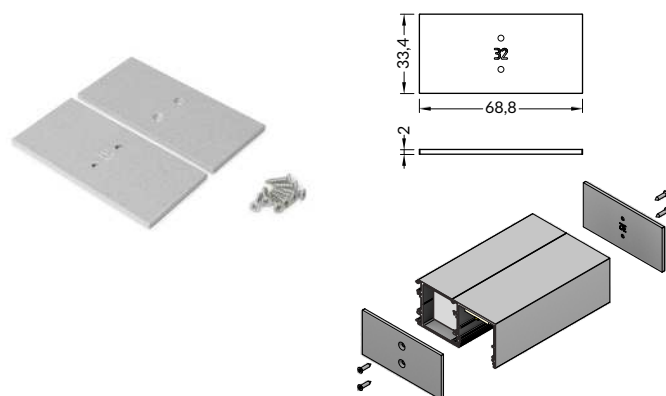

Endkappe VARIO30-34 aus Metall / VARIO30-34 metal ending

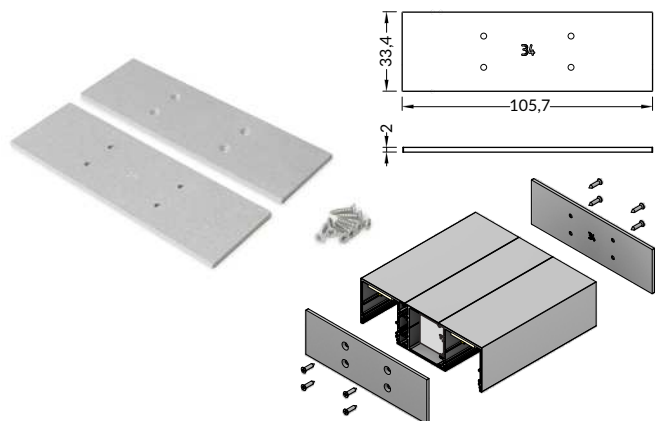

die Endkappe für die Variante

weiß

silbern

schwarz

ending for variant

white

silver

black

VARIO30-16

V4550001s

V4550022s

V4550002s

VARIO30-19

V4560001s

V4560022s

V4560002s

VARIO30-27

V4570001s

V4570022s

V4570002s

VARIO30-32

V4580001s

V4580022s

V4580002s

VARIO30-34

V4590001s

V4590022s

V4590002s

Artikelnummer = 1 Set = 20 Stück, Verpackung > siehe bitte Preisliste / INDEX = 1 set = 2 pcs, package > check the pricelist

für die Profile / for profiles

VARIO30-02

60 Grad / deg

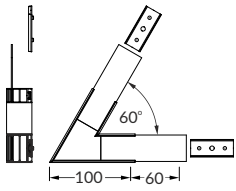

90 Grad / deg

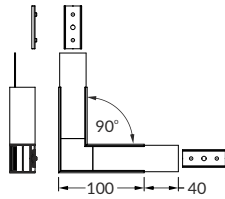

90 Grad gebogen / deg bent

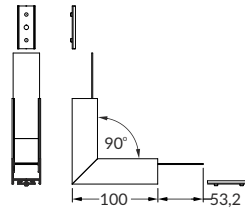

120 Grad / deg

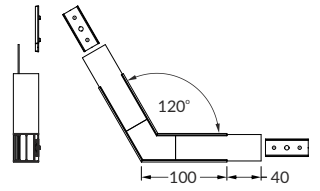

135 Grad / deg

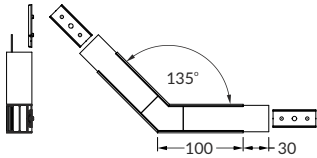

180 Grad / deg

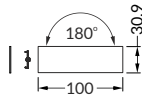

270 Grad gebogen / deg bent

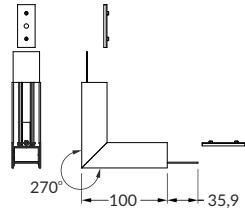

weiß eloxiert schwarz eloxiert

white anodized black anodized

Verbinder 60 Grad für VARIO30-02 / VARIO30-02 connector 60 deg	V4660001s	V4660020s	V4660021s
Verbinder 90 Grad für VARIO30-02 / VARIO30-02 connector 90 deg	V4670001s	V4670020s	V4670021s
Verbinder 90 Grad für VARIO30-02 gebogen / VARIO30-02 connector 90 deg bent	V4680001s	V4680020s	V4680021s
Verbinder 120 Grad für VARIO30-02 / VARIO30-02 connector 120 deg	V4690001s	V4690020s	V4690021s
Verbinder 135 Grad für VARIO30-02 / VARIO30-02 connector 135 deg	V4700001s	V4700020s	V4700021s
Verbinder 180 Grad für VARIO30-0203 / VARIO30-0203 connector 180 deg	-	-	V4640000s
Verbinder 270 Grad für VARIO30-02 gebogen / VARIO30-02 connector 270 deg bent	V4710001s	V4710020s	V4710021s

Artikelnummer = 1 Set, Verpackung > siehe bitte Preisliste / INDEX = 1 set, package > check the pricelist

für die Profile / for profiles

VARIO30-03

180 Grad / deg

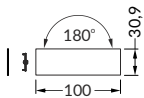

weiß eloxiert schwarz eloxiert

white anodized black anodized

Verbinder 180 Grad für VARIO30-0203 / VARIO30-0203 connector 180 deg	-	-	-	V4640000s
--	---	---	---	-----------

Artikelnummer = 1 Set, Verpackung > siehe bitte Preisliste / INDEX = 1 set, package > check the pricelist

EINBAUPROFILE RECESSED PROFILES

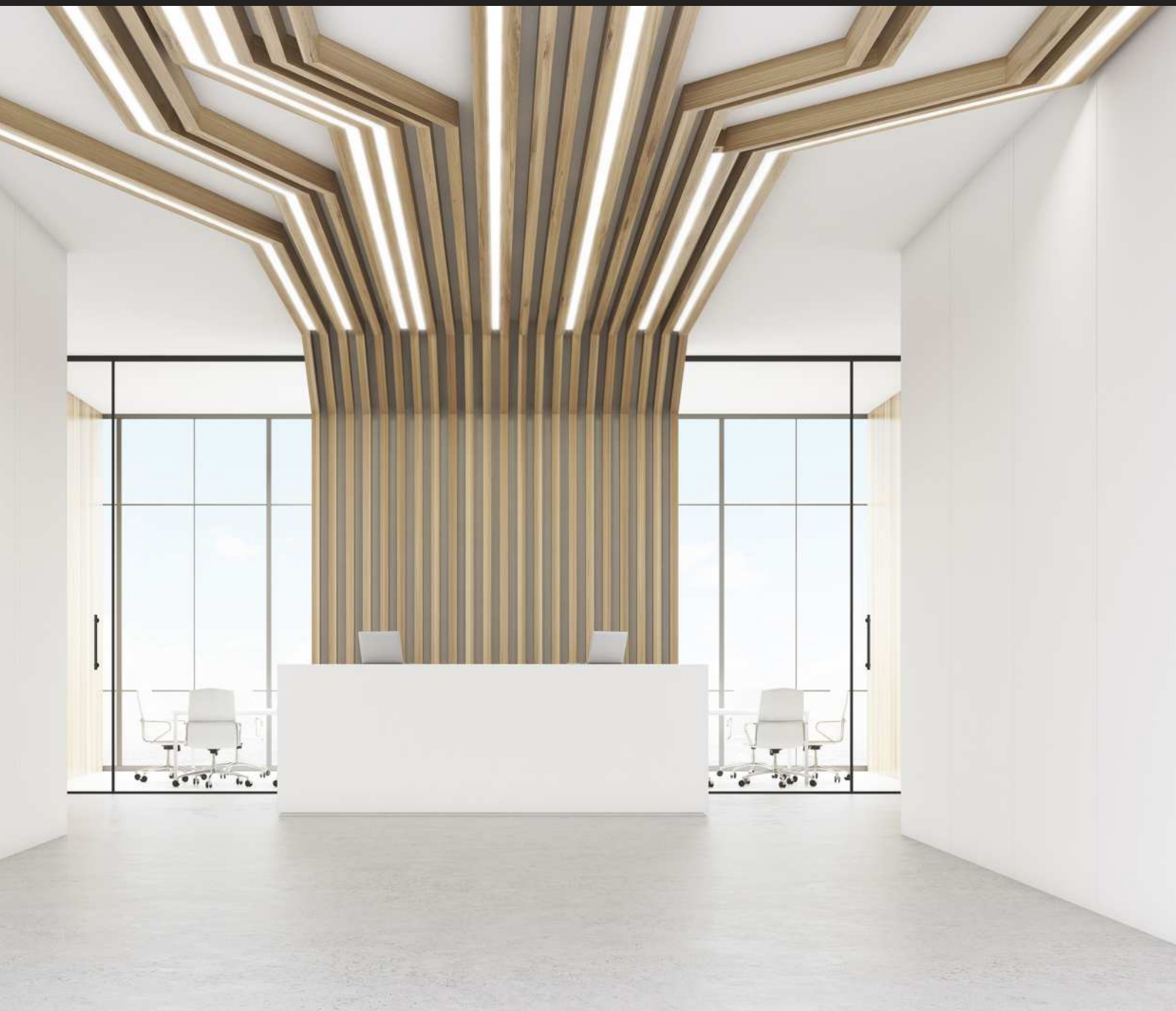

VARIO30-04	> 7.14
VARIO30-05	> 7.14
VARIO30-06	> 7.14
VARIO30-07	> 7.14

Halter / mountings	> 7.15
Endkappen / endings	> 7.15
Verbindungsstücke / connectors	> 7.16

Abdeckungen / diffusers	> 7.18
übrige / others	> 7.22



LED Profil / LED profile VARIO30-04

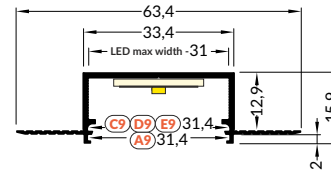
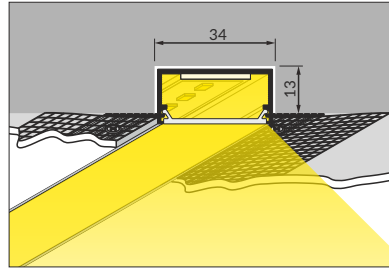

weiß	eloxiert	schwarz eloxiert	Rohaluminium
white	anodized	black anodized	raw
V3140001	V3140020	-	V3140000

Artikelnummer = 1 Stück, Länge 2.000 mm, Verpackung > siehe bitte Preisliste
INDEX = 1 pc, length 2000 mm, package > check the pricelist

LED Profil / LED profile VARIO30-05

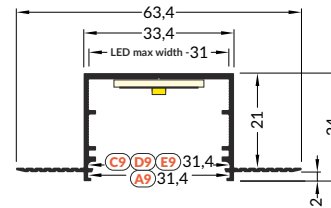
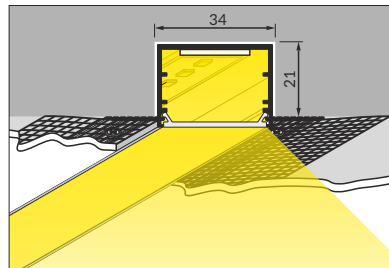

weiß	eloxiert	schwarz eloxiert	Rohaluminium
white	anodized	black anodized	raw
V3180001	V3180020	-	V3180000

Artikelnummer = 1 Stück, Länge 2.000 mm, Verpackung > siehe bitte Preisliste
INDEX = 1 pc, length 2000 mm, package > check the pricelist

LED Profil / LED profile VARIO30-06

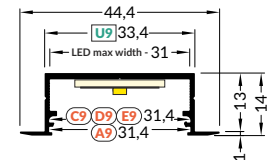
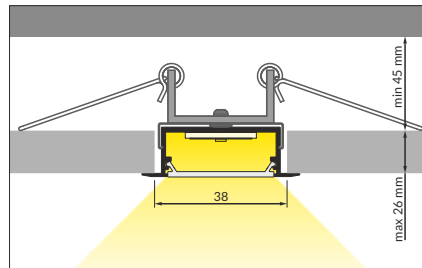
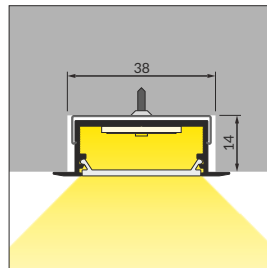

weiß	eloxiert	schwarz eloxiert	Rohaluminium
white	anodized	black anodized	raw
V3220001	V3220020	V3220021	V3220000

Artikelnummer = 1 Stück, Länge 2.000 mm, Verpackung > siehe bitte Preisliste
INDEX = 1 pc, length 2000 mm, package > check the pricelist

LED Profil / LED profile VARIO30-07

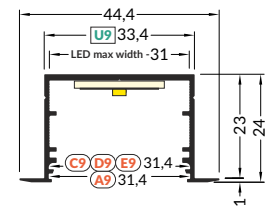
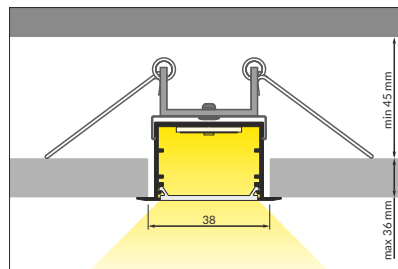
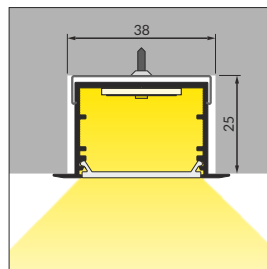

weiß	eloxiert	schwarz eloxiert	Rohaluminium
white	anodized	black anodized	raw
V3260001	V3260020	V3260021	V3260000

Artikelnummer = 1 Stück, Länge 2.000 mm, Verpackung > siehe bitte Preisliste
INDEX = 1 pc, length 2000 mm, package > check the pricelist

Die zugänglichen Längen: 1000 mm, 2000 mm, 3000 mm, 4000 mm. Die standardmäßige Toleranz der Länge von Profilen beträgt: +20 mm. Mehr Informationen >> 1.08.
Available lengths: 1000 mm, 2000 mm, 3000 mm, 4000 mm. The standard profile length tolerance is +20 mm. More details >> 1.08.



HALTER / MOUNTINGS

Halter U9 U9 mounting plate

Material: rostfreier Stahl
material: stainless steel

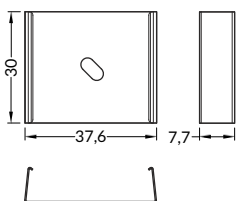

Halter U9 cone cone U9 mounting plate

Material: rostfreier Stahl
material: stainless steel

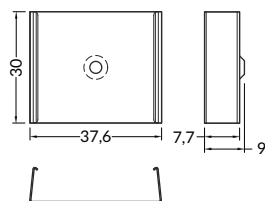

Halter U9 rack rack U9 mounting plate

Material: rostfreier Stahl
material: stainless steel

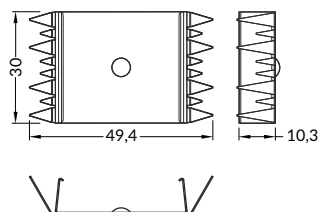

Halter U9 Feder spring U9 mounting plate

Material: rostfreier Stahl, Aluminium
material: stainless steel, aluminium

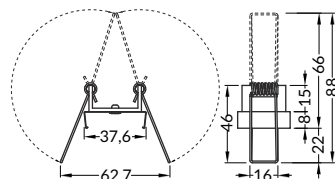

Halter

mountings

inox

inox

Halter U9 / U9 mounting plate

V4840019

Halter U9 cone / cone U9 mounting plate

V4850019

Artikelnummer = 10 Sets = 20 Stück, Verpackung > siehe bitte Preisliste / INDEX = 10 sets = 20 pcs, package > check the pricelist

Halter U9 rack / rack U9 mounting plate

V4860019

Halter U9 Feder / spring U9 mounting plate

V4620019s

Artikelnummer = 1 Set = 2 Stück, Verpackung > siehe bitte Preisliste / INDEX = 1 set = 2 pcs, package > check the pricelist

ENDKAPPEN / ENDINGS

Material: ABS

material: ABS

Endkappe VARIO30-04 VARIO30-04 ending

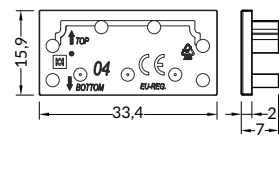

Endkappe VARIO30-05 VARIO30-05 ending

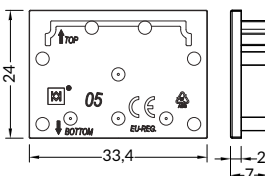
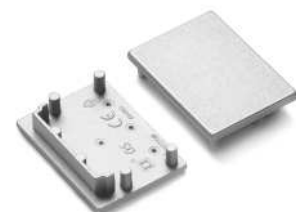

Endkappe VARIO30-06 VARIO30-06 ending

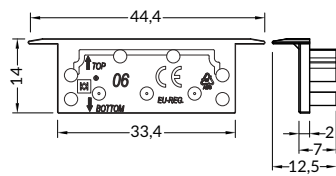

Endkappe VARIO30-07 VARIO30-07 ending

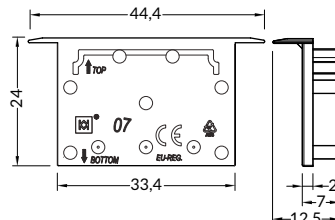
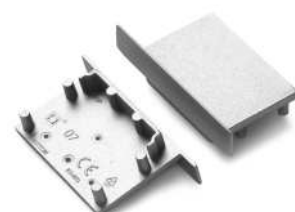

die Endkappe für das Profil

ending for profile

weiß

white

silbern

silver

schwarz

black

grau

grey

VARIO30-04

V4900001

V4900040

-

V4900022

VARIO30-05

V4910001

V4910040

-

V4910022

VARIO30-06

V4920001

V4920040

V4920040

V4920022

VARIO30-07

V4930001

V4930040

V4930002

V4930022

Artikelnummer = 10 Sets = 20 Stück, Verpackung > siehe bitte Preisliste / INDEX = 10 sets = 20 pcs, package > check the pricelist

für die Profile / for profiles

VARIO30-05

60 Grad / deg

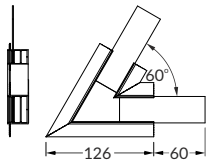

90 Grad / deg

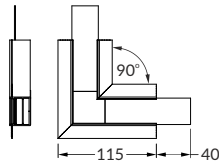

90 Grad gebogen / deg bent

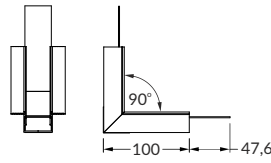

120 Grad / deg

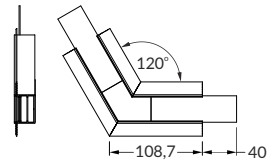

135 Grad / deg

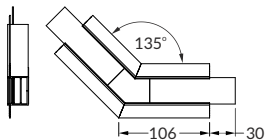

180 Grad / deg

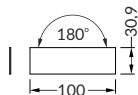

270 Grad gebogen / deg bent

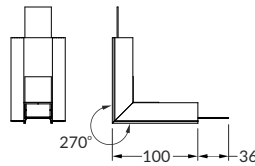

weiß	eloxiert	schwarz eloxiert
white	anodized	black anodized

Verbinder 60 Grad für VARIO30-05 / VARIO30-05 connector 60 deg	V4720001s	V4720020s	-
Verbinder 90 Grad für VARIO30-05 / VARIO30-05 connector 90 deg	V4730001s	V4730020s	-
Verbinder 90 Grad für VARIO30-05 gebogen VARIO30-05 connector 90 deg bent	V4740001s	V4740020s	-
Verbinder 120 Grad für VARIO30-05 / VARIO30-05 connector 120 deg	V4750001s	V4750020s	-
Verbinder 135 Grad für VARIO30-05 / VARIO30-05 connector 135 deg	V4760001s	V4760020s	-
Verbinder 180 Grad für VARIO30-05 / VARIO30-05 connector 180 deg	-	-	V4650000s
Verbinder 270 Grad für VARIO30-05 gebogen VARIO30-05 connector 270 deg bent	V4770001s	V4770020s	-

Artikelnummer = 1 Set, Verpackung > siehe bitte Preisliste / INDEX = 1 set, package > check the pricelist

für die Profile / for profiles

VARIO30-07

60 Grad / deg

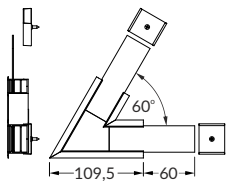

90 Grad / deg

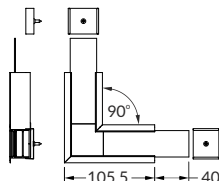

90 deg bent / deg bent

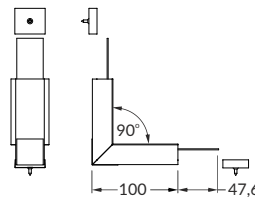

120 Grad / deg

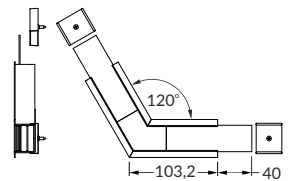

135 Grad / deg

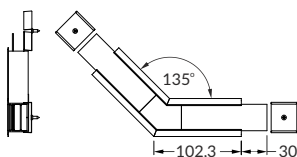

180 Grad / deg

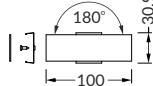

270 deg bent / deg bent

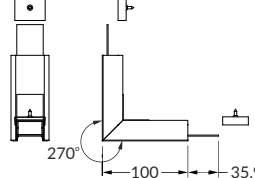

weiß	eloxiert	schwarz eloxiert
white	anodized	black anodized

Verbinder 60 Grad für VARIO30-07 / VARIO30-07 connector 60 deg	V4780001s	V4780020s	V4780021s
Verbinder 90 Grad für VARIO30-07 / VARIO30-07 connector 90 deg	V4790001s	V4790020s	V4790021s
Verbinder 90 Grad für VARIO30-07 gebogen VARIO30-07 connector 90 deg bent	V4800001s	V4800020s	V4800021s
Verbinder 120 Grad für VARIO30-07 / VARIO30-07 connector 120 deg	V4810001s	V4810020s	V4810021s
Verbinder 135 Grad für VARIO30-07 / VARIO30-07 connector 135 deg	V4820001s	V4820020s	V4820021s
Verbinder 180 Grad für VARIO30-07 / VARIO30-07 connector 180 deg	-	-	V4610000s
Verbinder 270 Grad für VARIO30-07 gebogen VARIO30-07 connector 270 deg bent	V4830001s	V4830020s	V4830021s

Artikelnummer = 1 Set, Verpackung > siehe bitte Preisliste / INDEX = 1 set, package > check the pricelist

KOMPATIBLES ZUBEHÖR SYSTEM ACCESSORIES



Abdeckungen / diffusers > 7.18
übrige / others > 7.22



Abdeckung A9 einziehbar / A9 slide diffuser

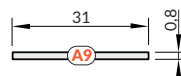

transparent
Material: PC
transparent
material: PC

satiniert
Material: PP
frosted
material: PP

opal
Material: PP
opal
material: PP



Achtung! Die Abmessungen des Platzes für die Montage von LED Lichtquelle / Note! Dimensions of the space to install LED source

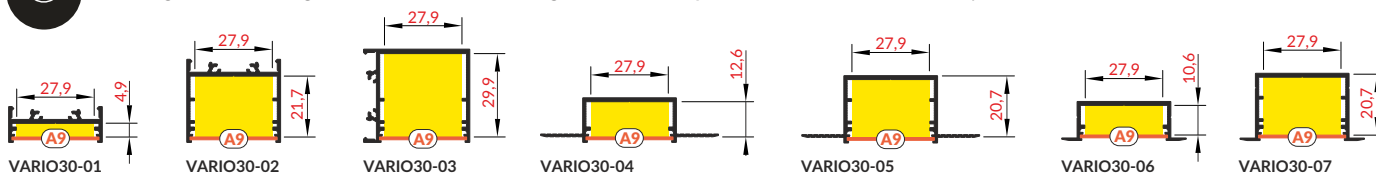

VARIO30-01

VARIO30-02

VARIO30-03

VARIO30-04

VARIO30-05

VARIO30-06

VARIO30-07

transparent

satiniert

opal

transparent

frosted

opal

Abdeckung A9 einziehbar / A9 slide diffuser

V3420016

V3420039

V3420038

Artikelnummer = 10 Stück, Länge 2.000 mm, Verpackung > siehe bitte Preisliste / INDEX = 10 pcs, length 2000 mm, package > check the pricelist

Abdeckung C9 einclipsbar / C9 click diffuser

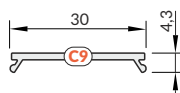

transparent
Material: PMMA
transparent
material: PMMA

opal
Material: PMMA
opal
material: PMMA



Achtung! Die Abmessungen des Platzes für die Montage von LED Lichtquelle / Note! Dimensions of the space to install LED source

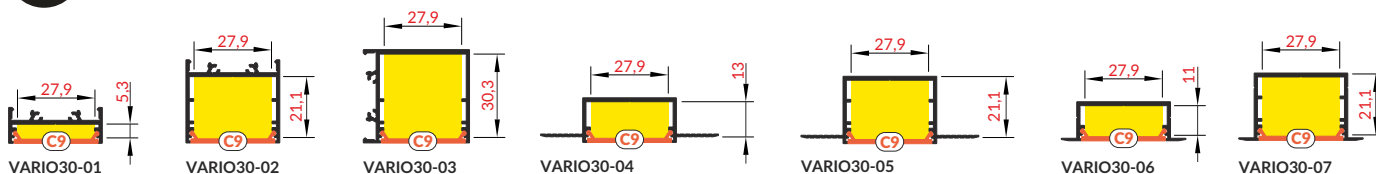

VARIO30-01

VARIO30-02

VARIO30-03

VARIO30-04

VARIO30-05

VARIO30-06

VARIO30-07

transparent

satiniert

opal

transparent

frosted

opal

Abdeckung C9 einclipsbar / C9 click diffuser

V3460016

-

V3460038

Artikelnummer = 1 Stück, Länge 2.000 mm, Verpackung > siehe bitte Preisliste / INDEX = 1 pc, length 2000 mm, package > check the pricelist



Abdeckung D9 einclipsbar / D9 click diffuser

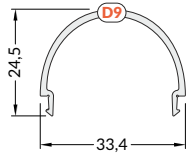

opal
Material: PMMA
opal
material: PMMA



Achtung! Die Abmessungen des Platzes für die Montage von LED Lichtquelle / **Note!** Dimensions of the space to install LED source

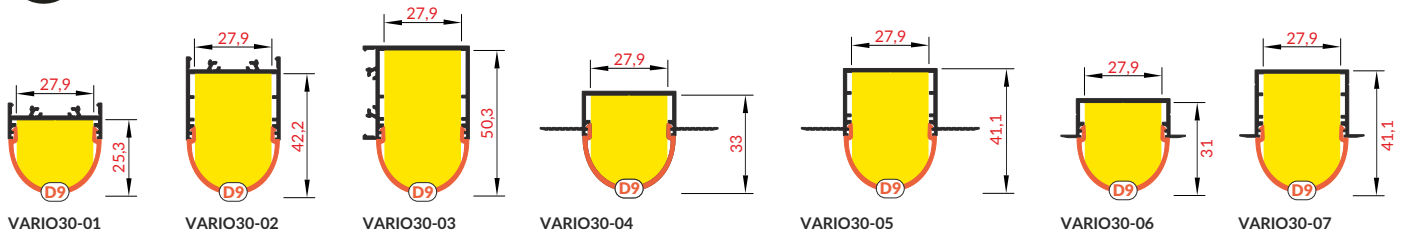

	transparent	satiniert	opal
	transparent	frosted	opal
Abdeckung D9 einclipsbar / D9 click diffuser	-	-	V3500038

Artikelnummer = 1 Stück, Länge 2.000 mm, Verpackung > siehe bitte Preisliste / INDEX = 1 pc, length 2000 mm, package > check the pricelist

Die Toleranz der Länge von Abdeckungen beträgt: +20 mm. Mehr Informationen >> 1.08.
The standard cover length tolerance is +20 mm. More details >> 1.08.

DIE ENDKAPPE FÜR DIE ABDECKUNG D9 / ENDINGS FOR D9 DIFFUSER

Material: PMMA

material: PMMA

Endkappe D9 D9 ending

Endkappe VARIO30-01-D9 VARIO30-01-D9 ending

Endkappe VARIO30-02-D9 VARIO30-02-D9 ending

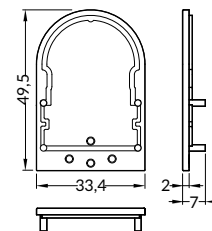
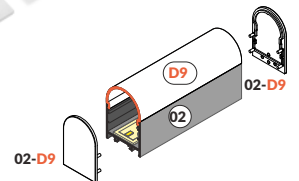
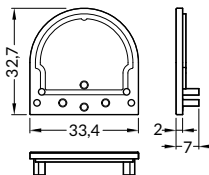
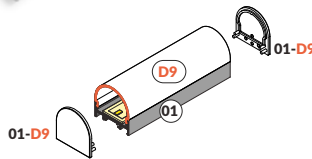
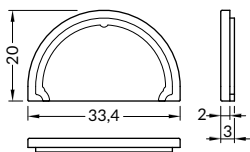
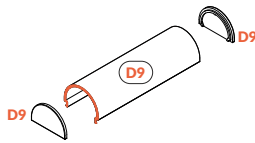

opal

opal

Endkappe D9 / D9 ending	V4980038
Endkappe VARIO30-01-D9 / VARIO30-01-D9 ending	V4500038
Endkappe VARIO30-02-D9 / VARIO30-02-D9 ending	V4540038

Artikelnummer = 10 Sets = 20 Stück, Verpackung > siehe bitte Preisliste / INDEX = 10 sets = 20 pcs, package > check the pricelist



Abdeckung E9 einclipsbar / E9 click diffuser

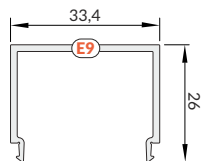

opal
Material: PMMA
opal
material: PMMA



Achtung! Die Abmessungen des Platzes für die Montage von LED Lichtquelle / Note! Dimensions of the space to install LED source

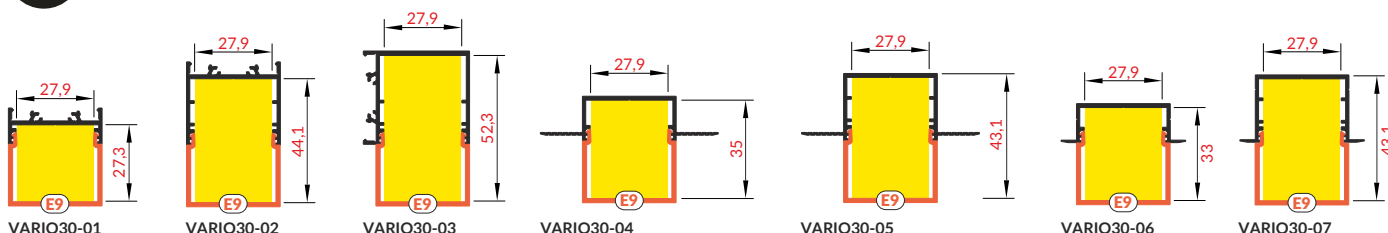

	transparent	satiniert	opal
Abdeckung E9 einclipsbar / E9 click diffuser	-	-	V3540038

Artikelnummer = 1 Stück, Länge 2.000 mm, Verpackung > siehe bitte Preisliste / INDEX = 1 pc, length 2000 mm, package > check the pricelist

Die Toleranz der Länge von Abdeckungen beträgt: +20 mm. Mehr Informationen >> 1.08.
The standard cover length tolerance is +20 mm. More details >> 1.08.

DIE ENDKAPPE FÜR DIE ABDECKUNG E9 / ENDINGS FOR E9 DIFFUSER

Material: PMMA

material: PMMA

Endkappe E9 E9 ending

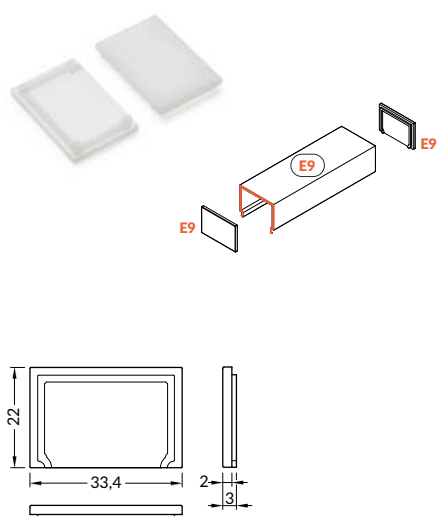

Endkappe VARIO30-01-E9 VARIO30-01-E9 ending

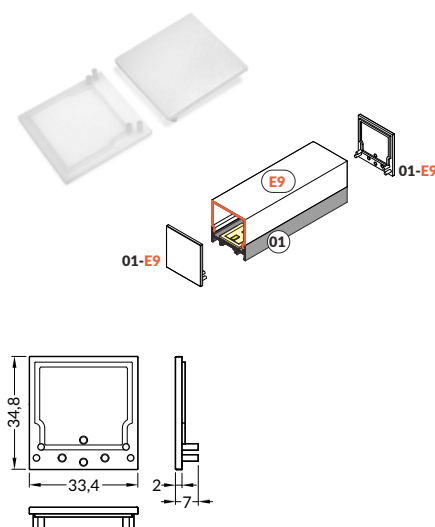

Endkappe VARIO30-02-E9 VARIO30-02-E9 ending

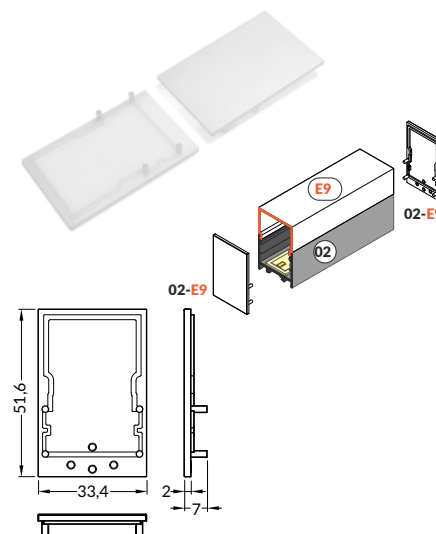

Endkappe E9 / E9 ending	V4990038
Endkappe VARIO30-01-E9 / VARIO30-01-E9 ending	V4510038
Endkappe VARIO30-02-E9 / VARIO30-02-E9 ending	V4550038

Artikelnummer = 10 Sets = 20 Stück, Verpackung > siehe bitte Preisliste / INDEX = 10 sets = 20 pcs, package > check the pricelist

LEUCHTEFFEKT LIGHTING EFFECT

Reflektor VARIO30 + LED Klemme VARIO30-1
VARIO30 reflector + VARIO30-1 LED clamp



empfohlen für die Profile:
Recommended for profiles:
02, 03 > 7.06
05, 07 > 7.14
und Abdeckungen: / and diffusers:
A9, C9, D9, E9 > 7.18

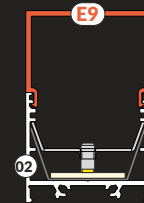
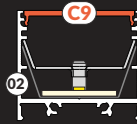

LED Montageteil für VARIO30 + LED Klemme VARIO30
VARIO30 LED mounting + VARIO30 LED clamp



empfohlen für die Profile:
Recommended for profiles:
02, 03 > 7.06
05, 07 > 7.14
und Abdeckungen: / and diffusers:
A9, C9, D9, E9 > 7.18

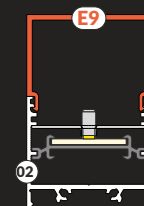
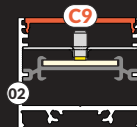

Klemme für LEDs für VARIO30-1
VARIO30-1 LED clamp



empfohlen für die Profile:
Recommended for profiles:
02, 03 > 7.06
05, 07 > 7.14
und Abdeckungen: / and diffusers:
A9, C9, D9, E9 > 7.18

Klemme für LEDs für VARIO30
VARIO30 LED clamp



empfohlen für die Profile:
Recommended for profiles:
04, 06 > 7.14
und Abdeckungen: / and diffusers:
A9, C9, D9, E9 > 7.18



LED Klemme VARIO30 VARIO30 LED clamp

Material: Stahl, Kunststoff
material: steel, plastic

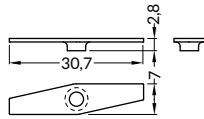

LED Klemme VARIO30-1 VARIO30-1 LED clamp

Material: Stahl, Kunststoff
material: steel, plastic

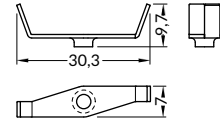

weiß lackiert

white painted

LED Klemme VARIO30 / VARIO30 LED clamp

V4630001

LED Klemme VARIO30-1 / VARIO30-1 LED clamp

V4520001

Artikelnummer = 1 Set = 2 Stück, Verpackung > siehe bitte Preisliste / INDEX = 1 set = 2 pcs, package > check the pricelist

Reflektor VARIO30 VARIO30 reflector

Material: Aluminium
material: aluminium

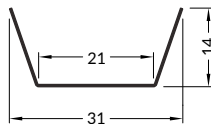

Reflektor VARIO30 / VARIO30 reflector

V3620000

Artikelnummer = 1 Stück, Länge 2.000 mm, Verpackung > siehe bitte Preisliste
INDEX = 1 pc, length 2000 mm, package > check the pricelist

Montageteil LED für VARIO30 VARIO30 LED mounting

Material: Aluminium
material: aluminium

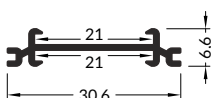

LED Montageteil für VARIO30 / VARIO30 LED mounting

Rohaluminium

raw aluminium

V3580000

Artikelnummer = 1 Stück, Länge 2.000 mm, Verpackung > siehe bitte Preisliste
INDEX = 1 pc, length 2000 mm, package > check the pricelist

Die zugänglichen Längen: 1000 mm, 2000 mm, 3000 mm, 4000 mm.
Die standardmäßige Toleranz der Länge von Profilen beträgt: +20 mm. Mehr Informationen >> 1.08.
Available lengths: 1000 mm, 2000 mm, 3000 mm, 4000 mm.
The standard profile length tolerance is +20 mm. More details >> 1.08.



2020

LED PROFILE
LED PROFILES

GROßE PROFILE / BIG PROFILES

53

GROßE PROFILE / BIG PROFILES



PHIL53

Profil PHIL53 / PHIL53 profile

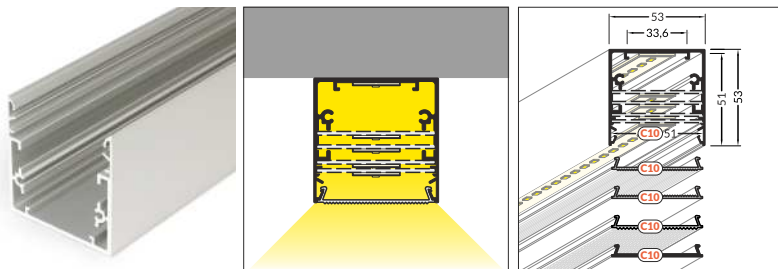

Endkappe PHIL53 / PHIL53 ending
Material: ABS / material: ABS

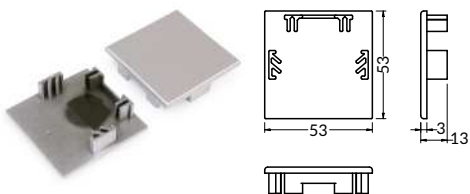

weiß lackiert	eloxiert	schwarz lackiert	Rohaluminium
white painted	anodized	black painted	raw
63530001	63530020	63530002	63530000

Artikelnummer = 1 Stück, Länge 2.000 mm, Verpackung > siehe bitte Preisliste
INDEX = 1 pc, length 2000 mm, package > check the pricelist

Die zugänglichen Längen: 1000 mm, 2000 mm, 3000 mm, 4000 mm.
Die standardmäßige Toleranz der Länge von Profilen beträgt: +20 mm.
Mehr Informationen >> 1.08.
Available lengths: 1000 mm, 2000 mm, 3000 mm, 4000 mm. The standard profile length tolerance is +20 mm. More details >> 1.08.

weiß	silbern	schwarz	grau
white	silver	black	grey
63640001	63640040	63640002	63640022

Artikelnummer = 1 Set = 2 Stück, Verpackung > siehe bitte Preisliste
INDEX = 1 set = 2 pcs, package > check the pricelist



PHIL EINBAU / PHIL RECESSED

Profil PHIL EINBAU / PHIL RECESSED profile

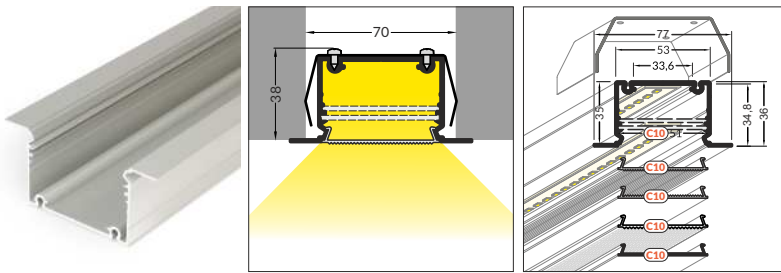

Endkappe für PHIL EINBAU / PHIL RECESSED ending
Material: ABS / material: ABS

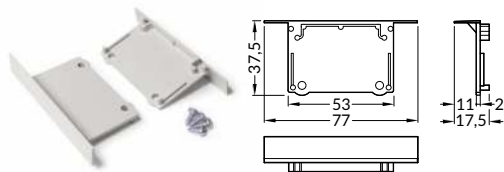

Endkappe für PHIL EINBAU aus Metal / PHIL RECESSED metal ending
Material: Stahl / material: steel

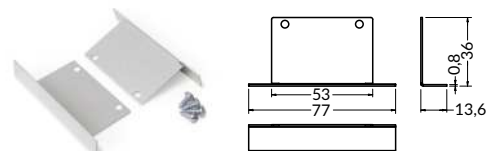

Halter für PHIL EINBAU / PHIL RECESSED holder
Material: rostfreier Stahl / material: stainless steel

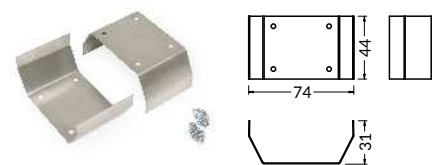

weiß lackiert	eloxiert	schwarz lackiert	Rohalu- minium
white painted	anodized	black painted	raw
97100001	97100020	97100002	97100000

Artikelnummer = 1 Stück, Länge 2.000 mm, Verpackung > siehe bitte Preisliste
INDEX = 1 pc, length 2000 mm, package > check the pricelist

Die zugänglichen Längen: 1000 mm, 2000 mm, 3000 mm, 4000 mm.
Die standardmäßige Toleranz der Länge von Profilen beträgt: +20 mm.
Mehr Informationen >> 1.08.
Available lengths: 1000 mm, 2000 mm, 3000 mm, 4000 mm. The standard profile length tolerance is +20 mm. More details >> 1.08.

weiß	silbern	schwarz	grau
white	silver	black	grey
97990001S	97990040S	97990002S	97990022S

Artikelnummer = 1 Set = 2 Stück, Verpackung > siehe bitte Preisliste
INDEX = 1 set = 2 pcs, package > check the pricelist

weiß	silbern	schwarz
white	silver	black
97120001	97120022	97120002

Artikelnummer = 1 Set = 2 Stück, Verpackung > siehe bitte Preisliste
INDEX = 1 set = 2 pcs, package > check the pricelist

inox
inox
97510019

Artikelnummer = 1 Set = 2 Stück, Verpackung > siehe bitte Preisliste
INDEX = 1 set = 2 pcs, package > check the pricelist

LOWI

Profil LOWI / LOWI profile

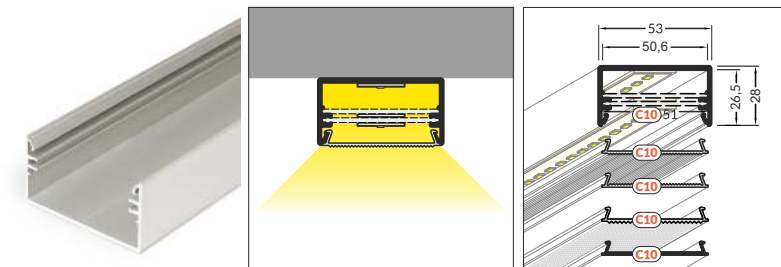

Endkappe für LOWI / LOWI ending
Material: ABS / material: ABS

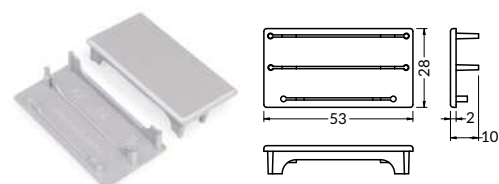

weiß lackiert	eloxiert	schwarz lackiert	Rohaluminium
white painted	anodized	black painted	raw
93030001	93030020	93030002	93030000

Artikelnummer = 1 Stück, Länge 2.000 mm, Verpackung > siehe bitte Preisliste
INDEX = 1 pc, length 2000 mm, package > check the pricelist

Die zugänglichen Längen: 1000 mm, 2000 mm, 3000 mm, 4000 mm.
Die standardmäßige Toleranz der Länge von Profilen beträgt: +20 mm.
Mehr Informationen >> 1.08.
Available lengths: 1000 mm, 2000 mm, 3000 mm, 4000 mm. The standard profile length tolerance is +20 mm. More details >> 1.08.

weiß	silbern	schwarz	grau
white	silver	black	grey
93066001	93070040	93070002	93070022

Artikelnummer = 1 Set = 2 Stück, Verpackung > siehe bitte Preisliste
INDEX = 1 set = 2 pcs, package > check the pricelist



Abdeckung C10 / C10 cover

Abdeckung C10 NARROW
Material: Polycarbonat
C10 NARROW cover
material: polycarbonate

Abdeckung C10 WIDE
Material: Polycarbonat
C10 WIDE cover
material: polycarbonate

Abdeckung C10 OPAL
Material: PMMA
C10 OPAL cover
material: PMMA

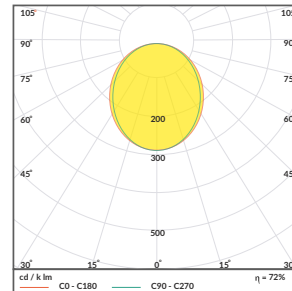
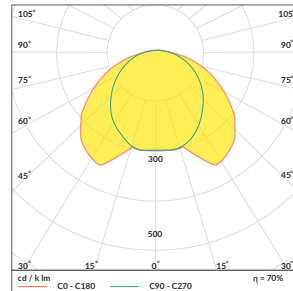
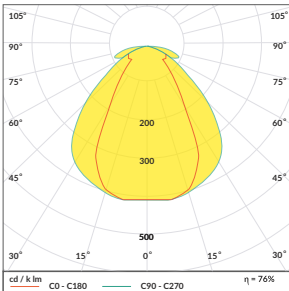
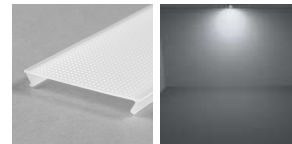
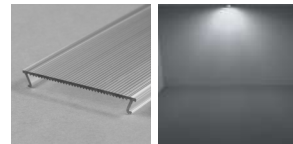
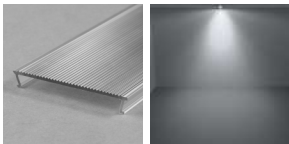
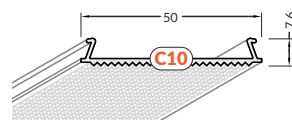
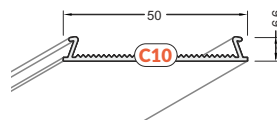
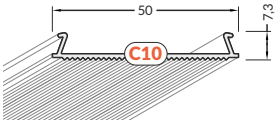

Der Vergleich von Lichtverteilungskurven bei der Anwendung von unterschiedlichen C10 Abdeckungen
Comparison of variations in the light curves measured on different C10 covers

NARROW	WIDE	OPAL
63620000	63590000	63690038

Artikelnummer = 1 Stück, Länge 2.000 mm,
Verpackung > siehe bitte Preisliste
INDEX = 1 pc, length 2000 mm,
package > check the pricelist

Die Toleranz der Länge von Abdeckungen beträgt: +20 mm.
Mehr Informationen >> 1.08.
The standard cover length tolerance is +20 mm.
More details >> 1.08.

Aluminiumabdeckplatte C10 / C10 aluminium cover

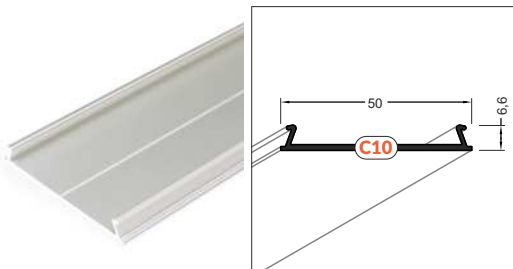

weiß lackiert	eloxiert	schwarz lackiert	Rohaluminium
white painted	anodized	black painted	raw
63560001	63560020	63560002	63560000

Artikelnummer = 1 Stück, Länge 2.000 mm, Verpackung > siehe bitte Preisliste
INDEX = 1 pc, length 2000 mm, package > check the pricelist

Die zugänglichen Längen: 1000 mm, 2000 mm, 3000 mm, 4000 mm. Die standardmäßige Toleranz der Länge von Profilen beträgt: +20 mm. Mehr Informationen >> 1.08.
Available lengths: 1000 mm, 2000 mm, 3000 mm, 4000 mm.
The standard profile length tolerance is +20 mm. More details >> 1.08.

Montageteil für LED / LED mounting

Montageteil für LED 50 / LED mounting 50
Material: Aluminium / material: aluminium

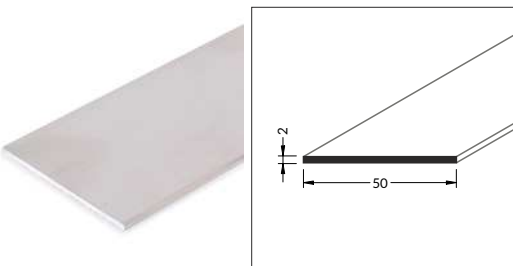

Rohaluminium

raw

25090000

Artikelnummer = 1 Stück, Länge 2.000 mm, Verpackung > siehe bitte Preisliste
INDEX = 1 pc, length 2000 mm, package > check the pricelist

Die zugänglichen Längen: 1000 mm, 2000 mm, 3000 mm, 4000 mm.
Die standardmäßige Toleranz der Länge von Profilen beträgt: +20 mm.
Mehr Informationen >> 1.08.
Available lengths: 1000 mm, 2000 mm, 3000 mm, 4000 mm.
The standard profile length tolerance is +20 mm. More details >> 1.08.

Die Abmessungen des Platzes für die Montage von LED Lichtquelle / Dimensions to install light source

PHIL53

Abdeckung C10 NARROW
C10 NARROW cover

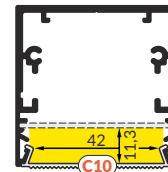
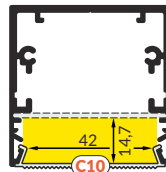
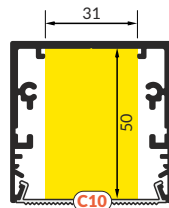

Abdeckung C10 OPAL
C10 OPAL cover



Aluminiumabdeckplatte C10
C10 aluminium cover



Abdeckung C10 WIDE
C10 WIDE cover

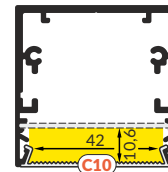
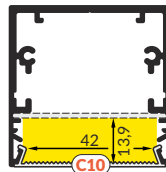
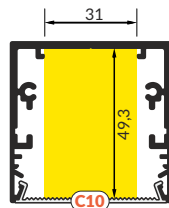

PHIL EINBAU / PHIL RECESSED

Abdeckung C10 NARROW
C10 NARROW cover

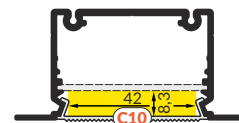
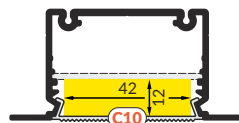
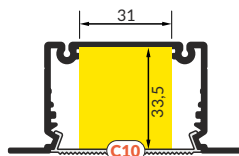

Abdeckung C10 OPAL
C10 OPAL cover



Aluminiumabdeckplatte C10
C10 aluminium cover



Abdeckung C10 WIDE
C10 WIDE cover

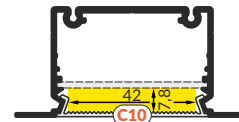
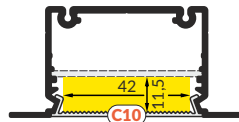
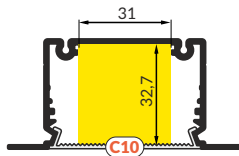

LOWI

Abdeckung C10 NARROW
C10 NARROW cover

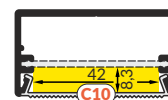
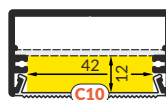
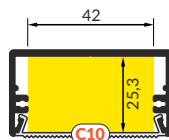

Abdeckung C10 OPAL
C10 OPAL cover



Aluminiumabdeckplatte C10
C10 aluminium cover



Abdeckung C10 WIDE
C10 WIDE cover

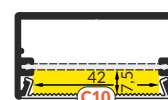
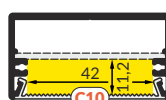
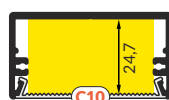



2020

LED PROFILE
LED PROFILES

LED ZUBEHÖR / LED ACCESSORIES



HOCHWERTIGE LICHTQUALITÄT FÜR ANSPRUCHSVOLLSTE ANWENDUNGEN

HIGH QUALITY LIGHT FOR THE MOST DEMANDING APPLICATIONS



3 SDCM	111-150 lm/W	50.000 h	Haltbarkeit durability	5 Jahre	Garantie warranty	CE
-----------	-----------------	----------	---------------------------	------------	----------------------	----

- gleichmäßige Beleuchtung dank der Spannungsstabilisierung auf der gesamten Länge des Bandes
- es ist einzigartige Version Premium White für perfekt entworfene, gesättigte Farben erhältlich
- hohe Lichtstromwerte, auch als Hauptbeleuchtung zu verwenden
- eine ideale Lösung für die Beleuchtung von Geschäften und Ausstellungen
- 5 und 50 m Rollen erhältlich
- hochwertiges Grundband zum Aufkleben

- even illuminating thanks to stabilisation of the voltage along the entire length of the strip
- a unique Premium White version is available for brilliantly reproduced, saturated colours
- high luminous flux values, can also be used as primary lighting
- ideal solution for lighting shops and exhibitions
- available in 5 and 50 metre reels
- high-quality adhesive backing tape for adhesive bonding



Vergleich der Beleuchtungswirkung mit Standardlichtquellen (links) und Premium White-Quellen (rechts)
Comparison of lighting effects with standard light sources (left) and Premium White light sources (right)

Ra>90

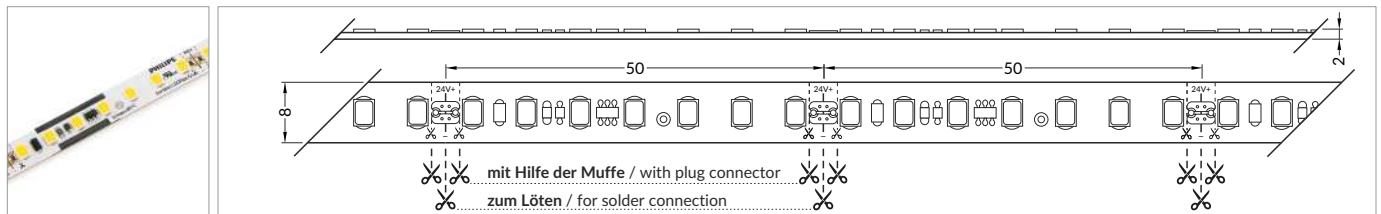

Ra>80

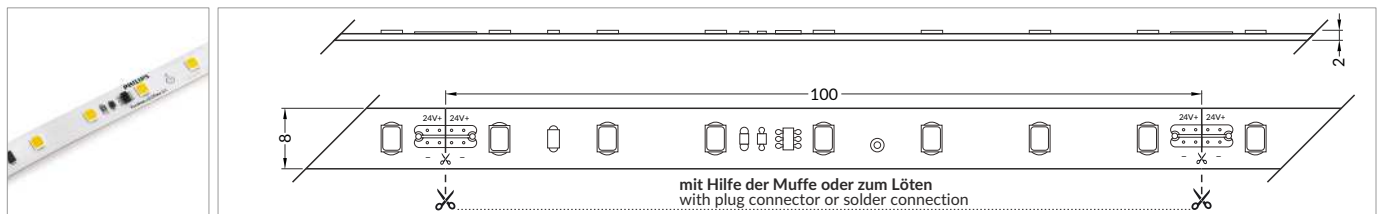

2500
lm/m

	Spannung voltage	P/m P/m	Lichtströmung luminous flux	Farbe colour	Rollenlänge reel length	Standard standard	Kraft power	Artikelnummer index
PHILIPS Fortimo LEDFlex	24V	140 P/m	2500 lm/m	927	5 m	(P)	22,5 W/m	B4995800
PHILIPS Fortimo LEDFlex	24V	140 P/m	2500 lm/m	930PW	5 m	(P)	21,2 W/m	B4995600
PHILIPS Fortimo LEDFlex	24V	140 P/m	2500 lm/m	940PW	5 m	(P)	20 W/m	B4995700
PHILIPS Fortimo LEDFlex	24V	140 P/m	2500 lm/m	965	5 m	(P)	20 W/m	B4995900
PHILIPS Fortimo LEDFlex	24V	70 P/m	2500 lm/m	830	5 m	(P)	18,9 W/m	B4996000
PHILIPS Fortimo LEDFlex	24V	70 P/m	2500 lm/m	830	50 m	(P)	18,9 W/m	B4996200
PHILIPS Fortimo LEDFlex	24V	70 P/m	2500 lm/m	840	5 m	(P)	17,6 W/m	B4996100
PHILIPS Fortimo LEDFlex	24V	70 P/m	2500 lm/m	840	50 m	(P)	17,6 W/m	B4996300

Die Mindestbestellmenge = eine Rolle / MOQ = 1 reel

2000
lm/m

	Spannung voltage	P/m P/m	Lichtströmung luminous flux	Farbe colour	Rollenlänge reel length	Standard standard	Kraft power	Artikelnummer index
PHILIPS Fortimo LEDFlex	24V	140 P/m	2000 lm/m	927	5 m	(P)	18 W/m	B4996600
PHILIPS Fortimo LEDFlex	24V	140 P/m	2000 lm/m	930PW	5 m	(P)	17,1 W/m	B4996400
PHILIPS Fortimo LEDFlex	24V	140 P/m	2000 lm/m	930PW	50 m	(P)	17,1 W/m	B4997200
PHILIPS Fortimo LEDFlex	24V	140 P/m	2000 lm/m	940PW	5 m	(P)	16 W/m	B4996500
PHILIPS Fortimo LEDFlex	24V	140 P/m	2000 lm/m	940PW	50 m	(P)	16 W/m	B4997300
PHILIPS Fortimo LEDFlex	24V	140 P/m	2000 lm/m	965	5 m	(P)	16 W/m	B4996700
PHILIPS Fortimo LEDFlex	24V	70 P/m	2000 lm/m	827	5 m	(P)	15,6 W/m	B4996800
PHILIPS Fortimo LEDFlex	24V	70 P/m	2000 lm/m	830	5 m	(P)	14,9 W/m	B4996900
PHILIPS Fortimo LEDFlex	24V	70 P/m	2000 lm/m	830	50 m	(P)	14,9 W/m	B4997400
PHILIPS Fortimo LEDFlex	24V	70 P/m	2000 lm/m	840	5 m	(P)	13,8 W/m	B4997000
PHILIPS Fortimo LEDFlex	24V	70 P/m	2000 lm/m	840	50 m	(P)	13,8 W/m	B4997500
PHILIPS Fortimo LEDFlex	24V	70 P/m	2000 lm/m	865	5 m	(P)	13,8 W/m	B4997100

Die Mindestbestellmenge = eine Rolle / MOQ = 1 reel

1500
lm/m

	Spannung voltage	P/m P/m	Lichtströmung luminous flux	Farbe colour	Rollenlänge reel length	Standard standard	Kraft power	Artikelnummer index
PHILIPS Fortimo LEDFlex	24V	140 P/m	1500 lm/m	927	5 m	(P)	13,2 W/m	B4997800
PHILIPS Fortimo LEDFlex	24V	140 P/m	1500 lm/m	930PW	5 m	(P)	12,6 W/m	B4997600
PHILIPS Fortimo LEDFlex	24V	140 P/m	1500 lm/m	930PW	50 m	(P)	12,6 W/m	B4998400
PHILIPS Fortimo LEDFlex	24V	140 P/m	1500 lm/m	940PW	5 m	(P)	11,8 W/m	B4997700
PHILIPS Fortimo LEDFlex	24V	140 P/m	1500 lm/m	940PW	50 m	(P)	11,8 W/m	B4998500
PHILIPS Fortimo LEDFlex	24V	140 P/m	1500 lm/m	965	5 m	(P)	11,8 W/m	B4997900
PHILIPS Fortimo LEDFlex	24V	70 P/m	1500 lm/m	827	5 m	(P)	11,2 W/m	B4997800
PHILIPS Fortimo LEDFlex	24V	70 P/m	1500 lm/m	830	5 m	(P)	10,9 W/m	B4998100
PHILIPS Fortimo LEDFlex	24V	70 P/m	1500 lm/m	830	50 m	(P)	10,9 W/m	B4998600
PHILIPS Fortimo LEDFlex	24V	70 P/m	1500 lm/m	840	5 m	(P)	10 W/m	B4998200
PHILIPS Fortimo LEDFlex	24V	70 P/m	1500 lm/m	840	50 m	(P)	10 W/m	B4998700
PHILIPS Fortimo LEDFlex	24V	70 P/m	1500 lm/m	865	5 m	(P)	10 W/m	B4998300

Die Mindestbestellmenge = eine Rolle / MOQ = 1 reel

1000
lm/m

	Spannung voltage	P/m P/m	Lichtströmung luminous flux	Farbe colour	Rollenlänge reel length	Standard standard	Kraft power	Artikelnummer index
PHILIPS Fortimo LEDFlex	24V	140 P/m	1000 lm/m	927	5 m	(P)	8,6 W/m	B4999400
PHILIPS Fortimo LEDFlex	24V	140 P/m	1000 lm/m	930PW	5 m	(P)	8,2 W/m	B4998800
PHILIPS Fortimo LEDFlex	24V	140 P/m	1000 lm/m	930PW	50 m	(P)	8,2 W/m	B4999600
PHILIPS Fortimo LEDFlex	24V	140 P/m	1000 lm/m	940PW	5 m	(P)	7,6 W/m	B4998900
PHILIPS Fortimo LEDFlex	24V	140 P/m	1000 lm/m	940PW	50 m	(P)	7,6 W/m	B4999700
PHILIPS Fortimo LEDFlex	24V	140 P/m	1000 lm/m	965	5 m	(P)	7,6 W/m	B4999500
PHILIPS Fortimo LEDFlex	24V	70 P/m	1000 lm/m	827	5 m	(P)	7,4 W/m	B4999000
PHILIPS Fortimo LEDFlex	24V	70 P/m	1000 lm/m	830	5 m	(P)	7,1 W/m	B4999100
PHILIPS Fortimo LEDFlex	24V	70 P/m	1000 lm/m	830	50 m	(P)	7,1 W/m	B4999800
PHILIPS Fortimo LEDFlex	24V	70 P/m	1000 lm/m	840	5 m	(P)	6,6 W/m	B4999200
PHILIPS Fortimo LEDFlex	24V	70 P/m	1000 lm/m	840	50 m	(P)	6,6 W/m	B4999900
PHILIPS Fortimo LEDFlex	24V	70 P/m	1000 lm/m	865	5 m	(P)	6,6 W/m	B4999300

Die Mindestbestellmenge = eine Rolle / MOQ = 1 reel

PROFESSIONELLE BELEUCHTUNGSPARAMETER

PROFESSIONAL LIGHTING PARAMETERS

Ra>80

4
SDCM≤115
lm/W

20.000 h

Haltbarkeit
durability2
JahreGarantie
warranty

CE

RoHS

240
P/m

Ein dichtes 240 P/m Band ermöglicht eine kontinuierliche Lichtlinie, auch in Verbindung mit einem flachen LED GROOVE10 Profil.

The 240 P/m thick strip allows a continuous line of light to be achieved even in combination with the shallow GROOVE10 LED profile.

Luminent FLEX 900

8,5 W/m
880 lm/m
104 lm/W

8,5
W/m

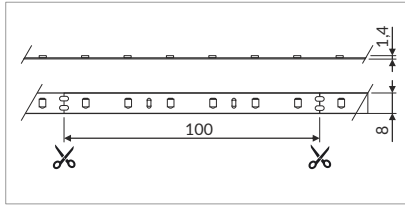

	Spannung	P/m	IP	Farbe	Standard	Artikelnummer
	voltage	P/m	IP	colour	standard	index
OSRAM LMNT-FX 900	24V	60 P/m	-	827	(P)	B4000100
OSRAM LMNT-FX 900	24V	60 P/m	-	830	(P)	B4000200
OSRAM LMNT-FX 900	24V	60 P/m	-	840	(P)	B4000300

Die Mindestbestellmenge = eine Rolle = 5 m / MOQ = 1 reel = 5 m

Luminent FLEX 1400

12 W/m
1380 lm/m
115 lm/W

115
lm/W

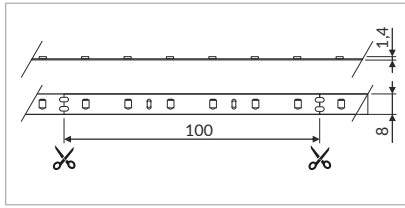

	Spannung	P/m	IP	Farbe	Standard	Artikelnummer
	voltage	P/m	IP	colour	standard	index
OSRAM LMNT-FX 1400	24V	70 P/m	-	827	(P)	B4000400
OSRAM LMNT-FX 1400	24V	70 P/m	-	830	(P)	B4000500
OSRAM LMNT-FX 1400	24V	70 P/m	-	840	(P)	B4000600

Die Mindestbestellmenge = eine Rolle = 5 m / MOQ = 1 reel = 5 m

Luminent FLEX 1000 Special

9,6 W/m
1000 lm/m
104 lm/W

240
P/m

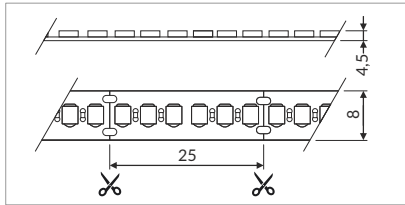

	Spannung	P/m	IP	Farbe	Standard	Artikelnummer
	voltage	P/m	IP	colour	standard	index
OSRAM LMNT-FX 1000	24V	240 P/m	-	830	(P)	B4000700
OSRAM LMNT-FX 1000	24V	240 P/m	-	840	(P)	B4000800

Die Mindestbestellmenge = eine Rolle = 5 m / MOQ = 1 reel = 5 m

Luminent FLEX 900 Protected

8,5 W/m
880 lm/m
104 lm/W

IP65

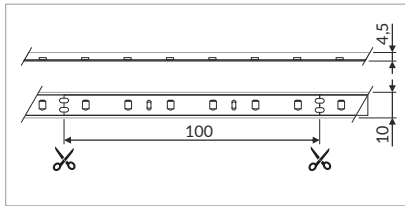

	Spannung	P/m	IP	Farbe	Standard	Artikelnummer
	voltage	P/m	IP	colour	standard	index
OSRAM LMNT-FX 900	24V	60 P/m	IP65	830	(P)	B4000900
OSRAM LMNT-FX 900	24V	60 P/m	IP65	840	(P)	B4001000

Die Mindestbestellmenge = eine Rolle = 5 m / MOQ = 1 reel = 5 m

Luminent FLEX 1400 Protected

12,5 W/m
1380 lm/m
110 lm/W

IP65

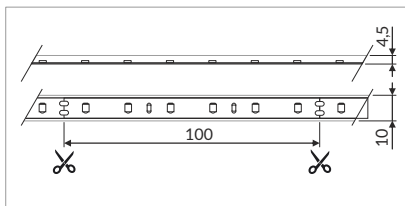

	Spannung	P/m	IP	Farbe	Standard	Artikelnummer
	voltage	P/m	IP	colour	standard	index
OSRAM LMNT-FX 1400	24V	70 P/m	IP65	830	(P)	B4001100
OSRAM LMNT-FX 1400	24V	70 P/m	IP65	840	(P)	B4001200

Die Mindestbestellmenge = eine Rolle = 5 m / MOQ = 1 reel = 5 m

Hochqualitative Leuchtdioden, passend für LED TOPMET Profile / High-quality LED chips, adapted to TOPMET LED profiles

LG Leuchtdioden LED LG Innotek
LG Innotek LED chips

Ra>80

3 SDCM

138 lm/W

5 Jahre

Garantie warranty

LED Modul LG 20 / LED module LG 20

14,4 W

- Empfohlen für Profile / Fits to profiles:
- LINEA20 >> 02.29
 - LINEA-IN20 >> 03.37
 - LINEA-IN20 TRIMLESS >> 03.45
 - VARIO30 >> 07.06, 07.14
 - PHIL53 >> 08.01
 - PHIL RECESSED / WPUST >> 08.02
 - LOWI >> 08.02

	Spannung	Lichtströmung	Farbe	Artikelnummer
	voltage	lumen output	colour	index
LED modul / LED module LG 20	24V	2000 lm	830	85670000
LED modul / LED module LG 20	24V	2000 lm	840	85680000

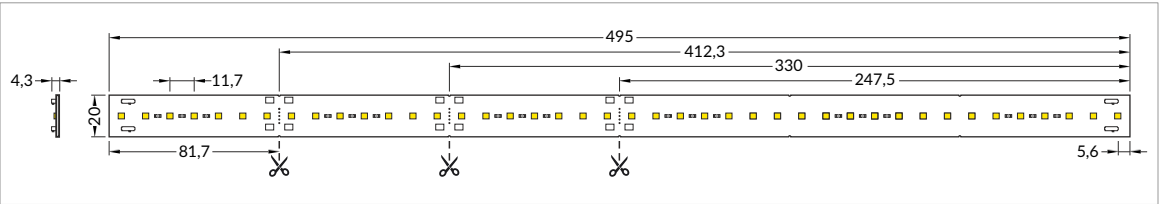

LED Modul LG 30 / LED module LG 30

14,5 W

- Empfohlen für Profile / Fits to profiles:
- VARIO30 >> 07.06, 07.14
 - PHIL53 >> 08.01
 - PHIL RECESSED / WPUST >> 08.02
 - LOWI >> 08.02

	Spannung	Lichtströmung	Farbe	Artikelnummer
	voltage	lumen output	colour	index
LED modul / LED module LG 30	24V	2000 lm	830	85650000
LED modul / LED module LG 30	24V	2000 lm	840	85660000

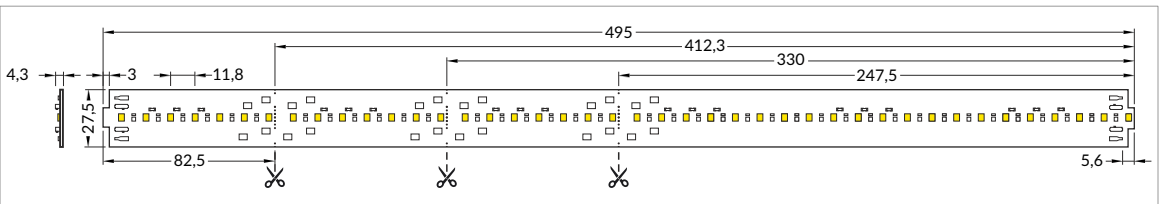

LED Modul LG 50 / LED module LG 50

19,2 W

- Empfohlen für Profile / Fits to profiles:
- PHIL53 >> 08.01
 - PHIL EINBAU / RECESSED >> 08.02
 - LOWI >> 08.02

	Spannung	Lichtströmung	Farbe	Artikelnummer
	voltage	lumen output	colour	index
LED modul / LED module LG 50	24V	2650 lm	830	85630000
LED modul / LED module LG 50	24V	2650 lm	840	85640000

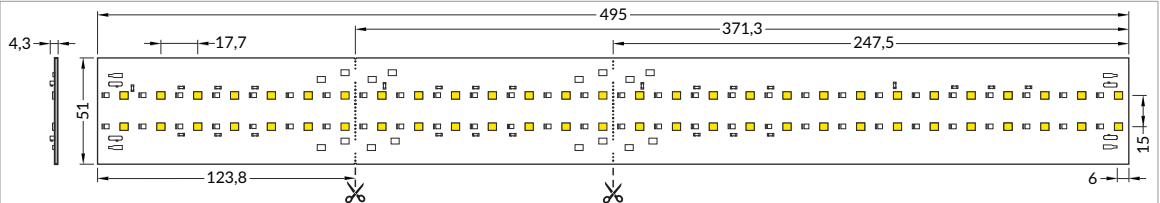

Zubehör / accessories



Verbindungsstück WAGO für LED Module
WAGO connecting element for LED modules
Raster 6 mm; zweipolig; Länge 30 mm
pitch 6 mm; 2-pole; length 30 mm
85690000



Montagegerät WAGO
WAGO operating tool
85700000

Brauchen Sie eine andere Lichtfarbe?
Auf Sonderbestellung können wir auch Lichtquellen mit der Farbe 820, 860 bzw. einer anderen vom Kunden gewünschten Farbe vorbereiten. Unser Handelsvertreter wird Sie gern beraten.
Do you need a different colour of light?
On special request we may also prepare light sources with the colour of 820, 860 or other specified by the customer. Ask our sales representative for details.

Die Netzteile für die LED 24 V / 24 V LED power supplies >> 9.07

LED Module PREMIUM TOPMET (P) / TOPMET PREMIUM LED modules (P)

50.000 h Haltbarkeit / 50.000 h durability

69x10 mm

1,5 W
146 lm (827)
148 lm (830)
155 lm (840)

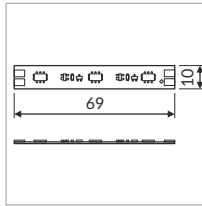

Abmessungen dimensions	Spannung voltage	P/modul P/module	Farbe colour	Artikel- nummer index
69x10 mm	12 V	3 LED	827	85600300
69x10 mm	12 V	3 LED	830	85610300
69x10 mm	12 V	3 LED	840	85620300

fi30 mm

1,5 W
106 lm (827)
110 lm (830)
115 lm (840)

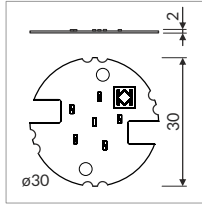

Abmessungen dimensions	Spannung voltage	P/modul P/module	Farbe barwa	Artikel- nummer index
fi30 mm	12 V	6 LED	827	85414072
fi30 mm	12 V	6 LED	830	85414074
fi30 mm	12 V	6 LED	840	85414073

LED Streifen Serie STANDARD (S) / STANDARD LED strips (S)

60 P/m

3528
6-7 lm/LED
4,8 W/m
360 lm/m ± 10%

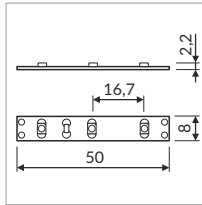

Spannung voltage	P/m P/m	Farbe colour	IP	Standard	Artikel- nummer index
12V	60 P/m	828-832	-	(S)	B4200000
12V	60 P/m	840-845	-	(S)	B4210000

Die Mindestbestellmenge = eine Rolle = 5 m / MOQ = 1 reel = 5 m

120 P/m

3528
6-7 lm/LED
9,6 W/m
720 lm/m ± 10%

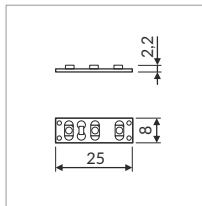

Spannung voltage	P/m P/m	Farbe colour	IP	Standard	Artikel- nummer index
12V	120 P/m	828-832	-	(S)	B4240000
12V	120 P/m	840-845	-	(S)	B4250000

Die Mindestbestellmenge = eine Rolle = 5 m / MOQ = 1 reel = 5 m

LED Streifen Serie BUDGET (B) / BUDGET LED strips (B)

warm-kalt
warm-cool
120 P/m

3528
9,6 W/m

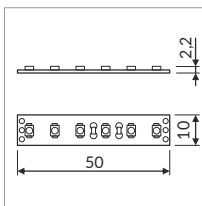
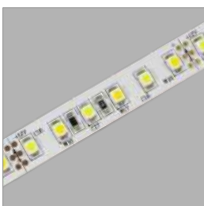

Spannung voltage	P/m P/m	Farbe colour	IP	Standard	Artikel- nummer index
12V	120 P/m	warm-kalt weiß warm-cool white	-	(B)	84509900

Die Mindestbestellmenge = eine Rolle = 5 m / MOQ = 1 reel = 5 m

Vario white Belichtungssystem / Vario white controlling >> 9.13

RGB
60 P/m
IP65

5050
14,4 W/m

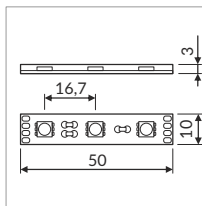
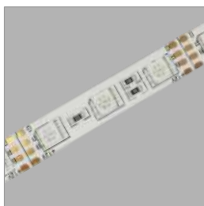

Spannung voltage	P/m P/m	Farbe colour	IP	Standard	Artikel- nummer index
12V	120 P/m	RGB	65	(B)	85414077

Die Mindestbestellmenge = eine Rolle = 5 m / MOQ = 1 reel = 5 m

RGB Belichtungssystem / RGB controlling >> 9.14

OSRAM IP66, IP67

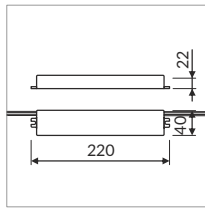

30 W
24 V / 220-240 V
IP66; OT; P

53500000

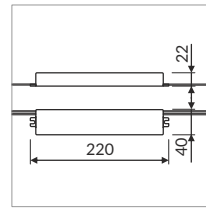

50 W
24 V / 220-240 V
IP66; OT; P

53510000

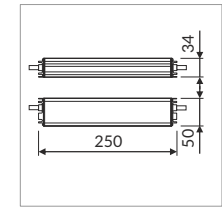

80 W
24 V / 220-240 V
IP67; OT; P

53520000

OSRAM ELEMENT

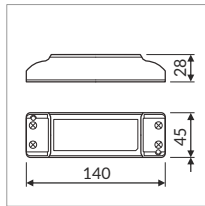

30 W
24 V / 220-240 V

99463776

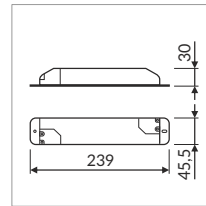

60 W
24 V / 220-240 V

99463790

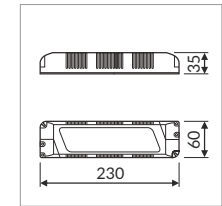

90 W
24 V / 220-240 V

99463813

LED Streifen von OSRAM / OSRAM LED strips >> 9.03-9.04

TOPMET fit30

Netzteile fit30 passen für Profile: / Fit30 power supplies are suitable to profiles:

- VARIO30 >> 07.06 / 07.14
- PHIL53 >> 08.01
- PHIL EINBAU / RECESSED >> 08.02
- LOWI >> 08.02

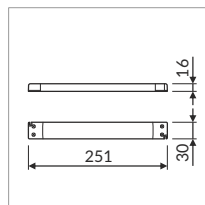

30 W
24 V / 200-240 V

15860000

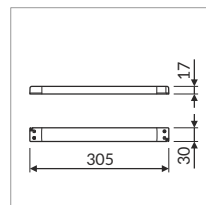

60 W
24 V / 200-240 V

15870000

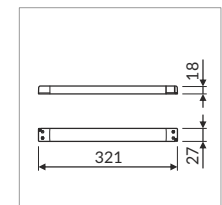

100 W
24 V / 100-240 V

15880000

LED Lichtquellen 24 V / 24 V LED sources >> 9.01-9.05

TOPMET

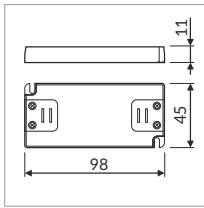

6 W
12 V / 200-240 V

15700000

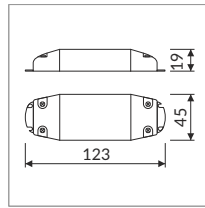

15 W
12 V / 200-240 V

15850000

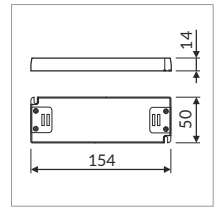
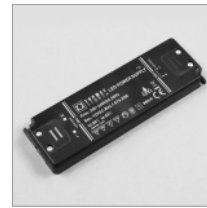

20 W
12 V / 200-240 V

15640000

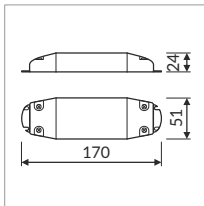

30 W
12 V / 200-240 V

15810000

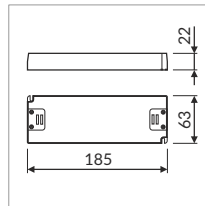

50 W
12 V / 200-240 V

15650000

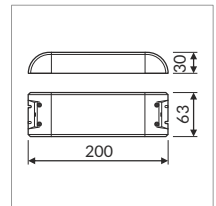

75 W
12 V / 200-240 V

15800000

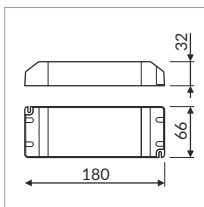

100 W
12 V / 100-240 V

15760000

Topmet behält sich das Recht vor, das Aussehen einzelner Speiseleitungen und die Parameter gering zu ändern.
TOPMET reserves the right to change the appearance of individual power supplies and slightly change the parameters.

sonstige / others

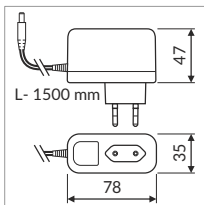

18 W
12 V / 100-240 V
Netzteil für LED mit Stecker / AC adapter

15820002

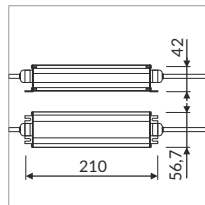

100 W
12 V / 200-240 V
IP68

15710000

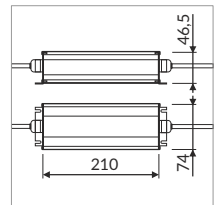

150 W
12 V / 200-240 V
IP68

15720000

Gehäuse für Netzteile / power supply cases

die maximalen Abmessungen der LED Netzteile:
LED power supplies maximum dimensions:

48 x 12 x 100

weiß	eloxiert	schwarz
white	anodized	black
67160001	67160020	67160002

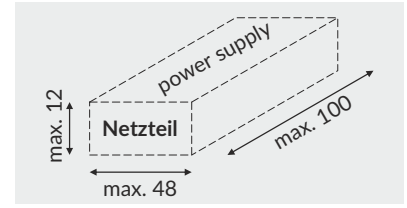
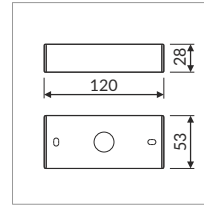

120 x 27 x 216

weiß	eloxiert	schwarz
white	anodized	black
67170001	67170020	67170002

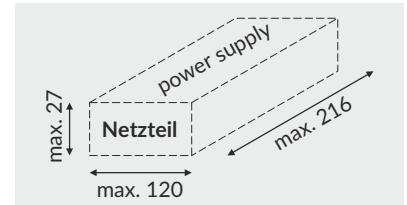
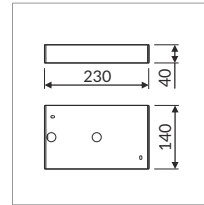

31 x 23 x 286

weiß	eloxiert	schwarz
white	anodized	black
67180001	67180020	67180002

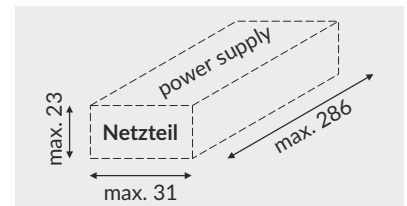
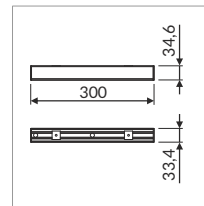
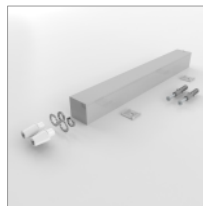

31 x 23 x 386

weiß	eloxiert	schwarz
white	anodized	black
67190001	67190020	67190002

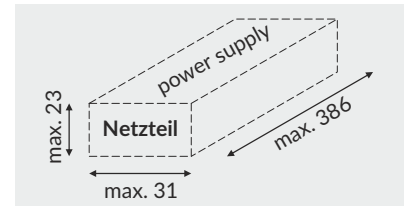
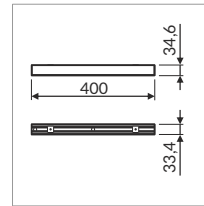
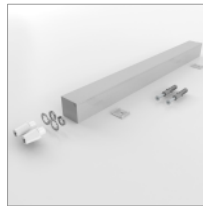

36 x 46 x 474

weiß	eloxiert	schwarz
white	anodized	black
67200001	67200020	67200002

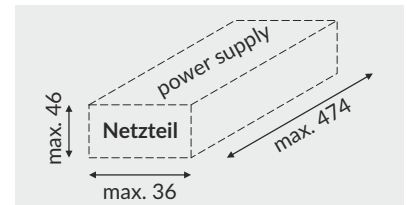
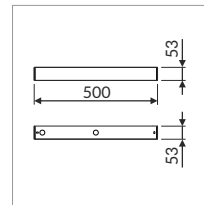
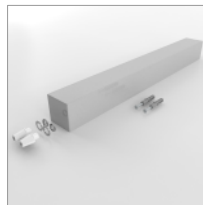

Steuerungssensoren und Schalter / lighting controllers and switches

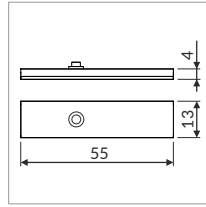

LED Schalter SU/GR/CO dimmbar
LED switch SU/GR/CO dimmable
12-24 V; 60-100 W

53850000

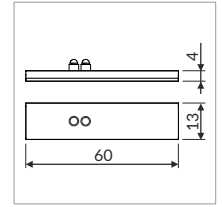

LED Schalter SU/GR/CO berührunglos dimmbar
LED switch SU/GR/CO touchless dimmable
12-24 V; 60-100 W

53860000

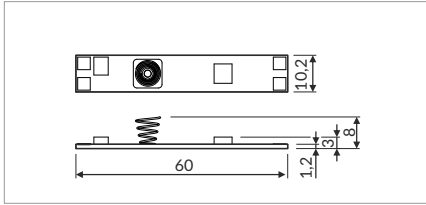

LED Berührungsschalter INSIDE dimmbar
LED switch INSIDE touch dimmable
12-24 V; 60-100 W

C5010000

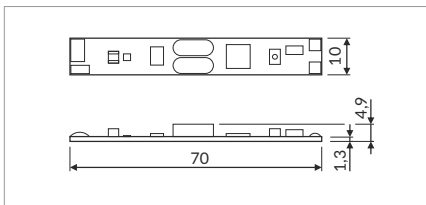
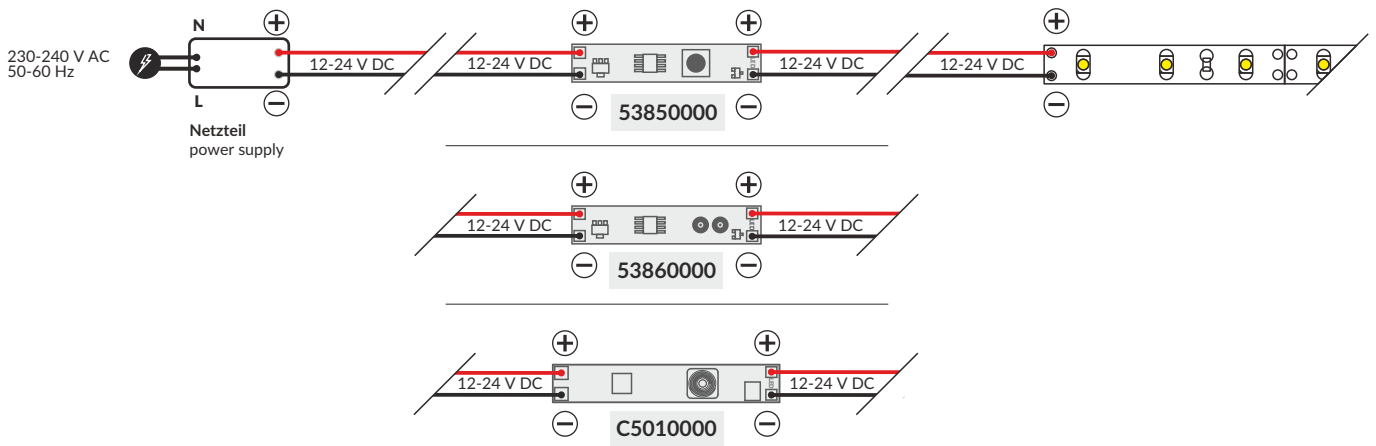

LED Controller Basisversion 1 Kanal
LED receiver basic 1 channel
12-24 V; 60-100 W

C5020000

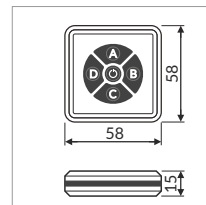

LED Fernbedienung Basisversion 4 Kanäle
LED remote controller basic 4 channel

C5030000

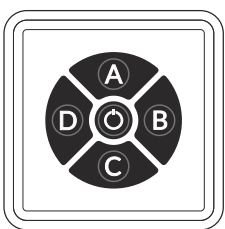

C5030000

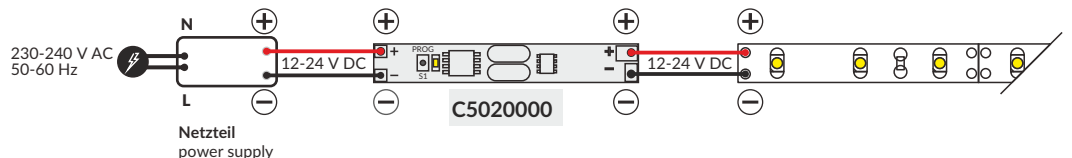



LED Türschalter berührungslos
LED switch door operated sensor
12-24 V; 30 W

15530000

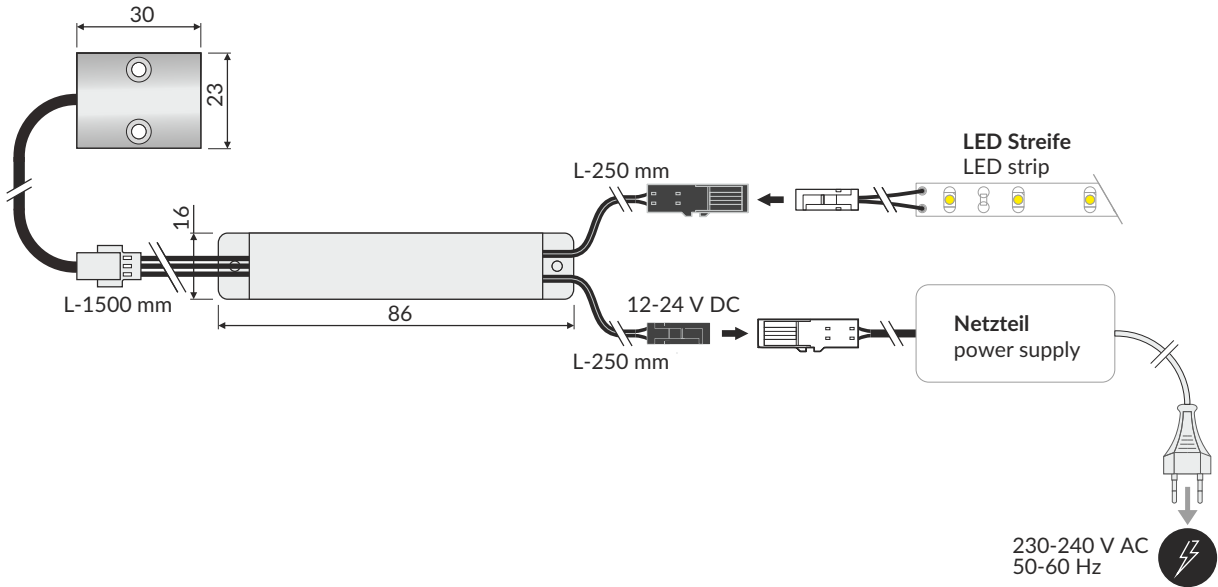
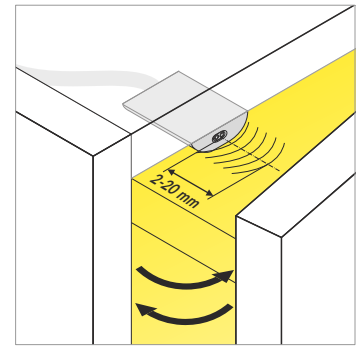

LED Handschalter berührungslos
LED switch hand operated sensor
12-24 V; 30 W

15540000

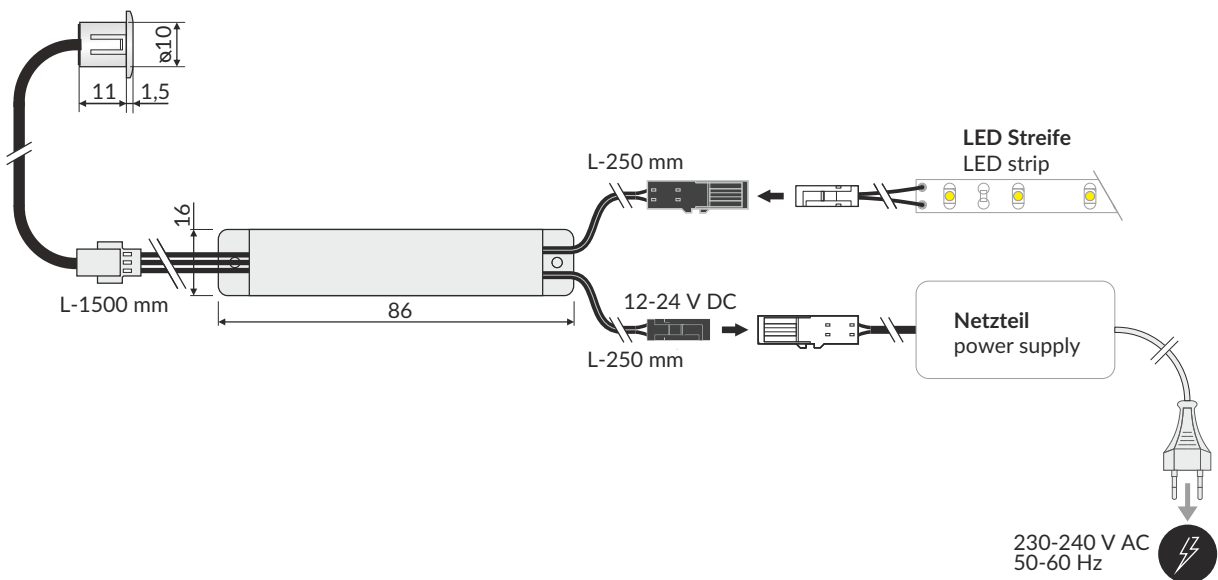
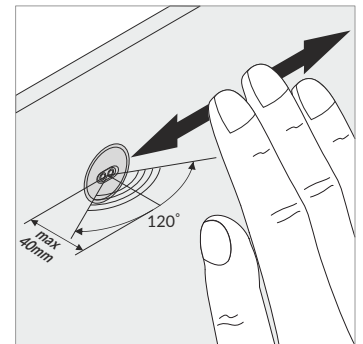



LED Berührungsschalter ON/OFF
LED switch touch sensor ON/OFF
12 V; 30 W

15630000

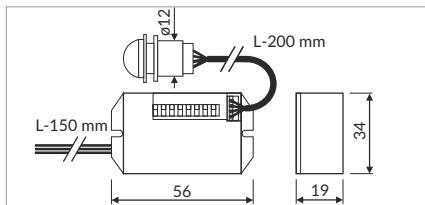
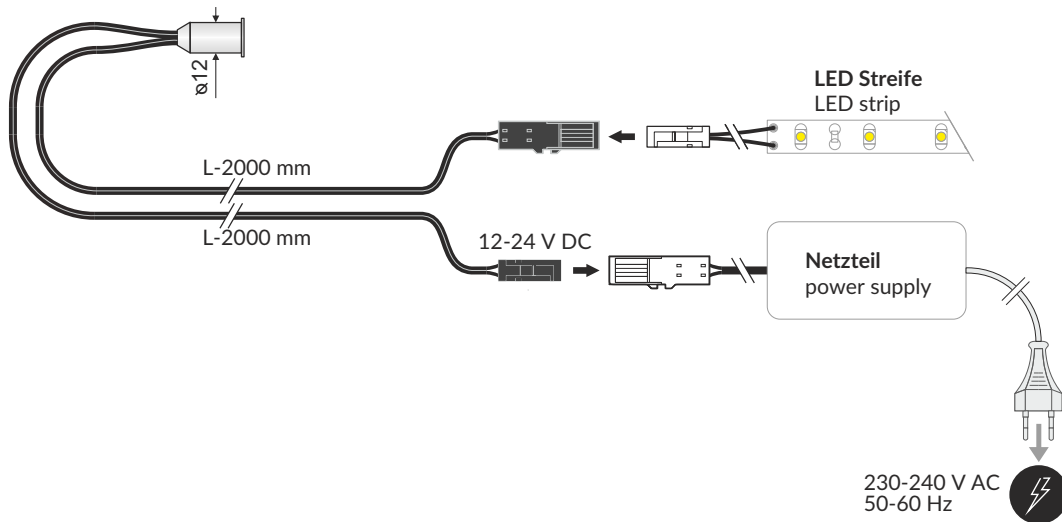
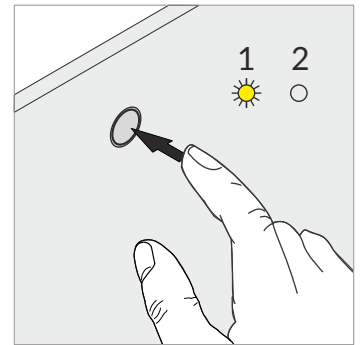

Bewegungssensor YCB1050
movement sensor YCB1050
230 V; 800 W

85414061

Vario white Beleuchtungssystem / Vario white lighting system

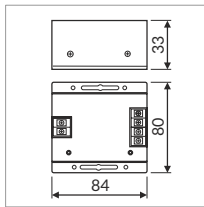

**LED Controller warmweiß-kaltweiß
2 Kanäle**
LED receiver warm-cold 2 channel
12V/24VDC; 144W/288W

78300000

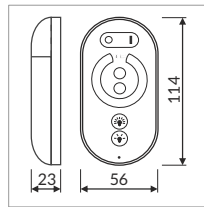

**LED Fernbedienung
warmweiß-kaltweiß**
LED remote controller warm-cold

78290000

Die Fernbedienung kann gleichzeitig ein Paar Controller bedienen.
LED remote controller operates with multiple drivers.

Topmet behält sich das Recht vor, das Aussehen einzelner Speiseleitungen und die Parameter gering zu ändern.

TOPMET reserves the right to change the appearance of individual power supplies and slightly change the parameters.

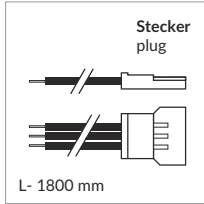

Kabel für LED / LED cable

3x0,22
1800 mm
1xMIKRO3 Stecker / 1xMIKRO3 plug

67030000

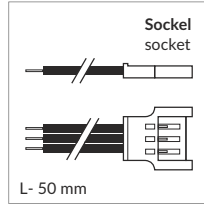
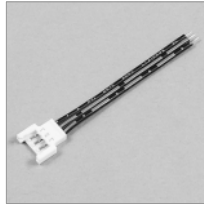

Kabel für LED / LED cable

3x0,22
50 mm
1xMIKRO3 Socket / 1xMIKRO3 socket

67020000

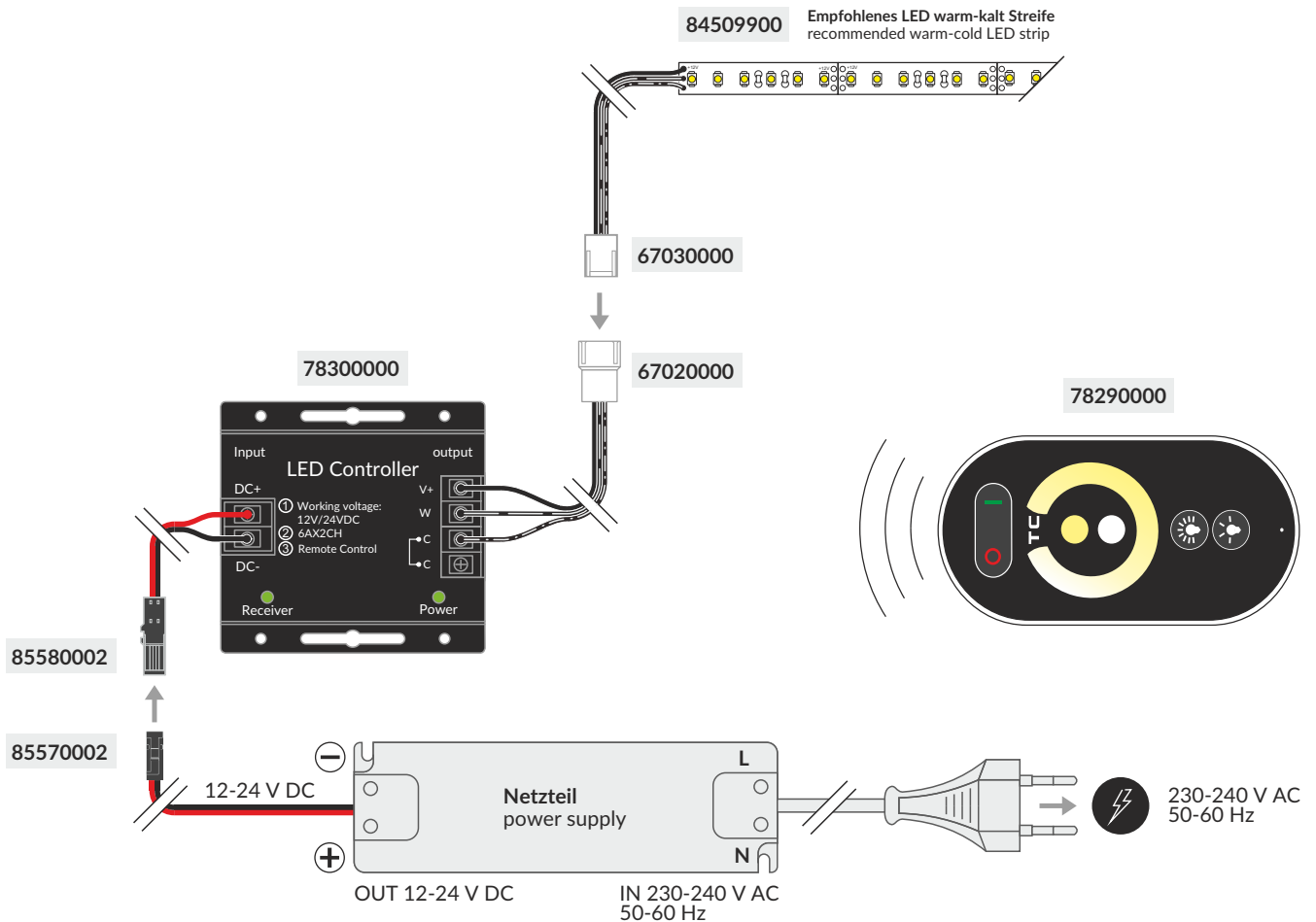

RGB Belichtungssystem / RGB lighting system

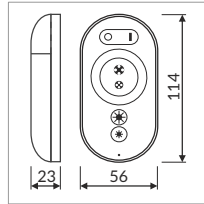
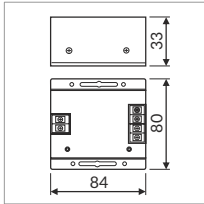

Die Fernbedienung kann gleichzeitig ein Paar Controller bedienen.
LED RGB remote controller operates with multiple drivers.

LED RGB Controller 3 Kanäle
LED receiver RGB 3 channel
12V/24VDC; 216W/432W

78450000

LED RGB Fernbedienung
LED remote controller RGB

78460000

Topmet behält sich das Recht vor, das Aussehen einzelner Speiseleitungen und die Parameter gering zu ändern.

TOPMET reserves the right to change the appearance of individual power supplies and slightly change the parameters.

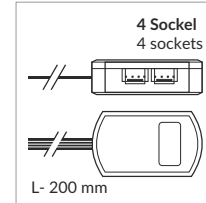
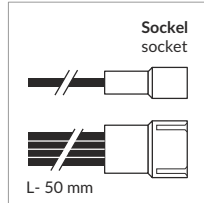
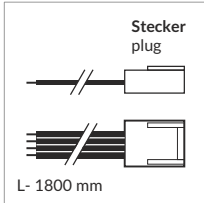

Kabel für LED RGB / RGB LED cable
4x0,5
1800 mm
1xMIKRO4 Stecker / 1xMIKRO4 plug

67060000

Kabel für LED RGB / RGB LED cable
4x0,5
50 mm
1xMIKRO4 Sockel / 1xMIKRO4 socket

67050000

LED RGB integrierter Verteiler
RGB LED distribution box
4x0,5
200 mm
4xMIKRO4 Sockel / 4xMIKRO4 socket

67040000

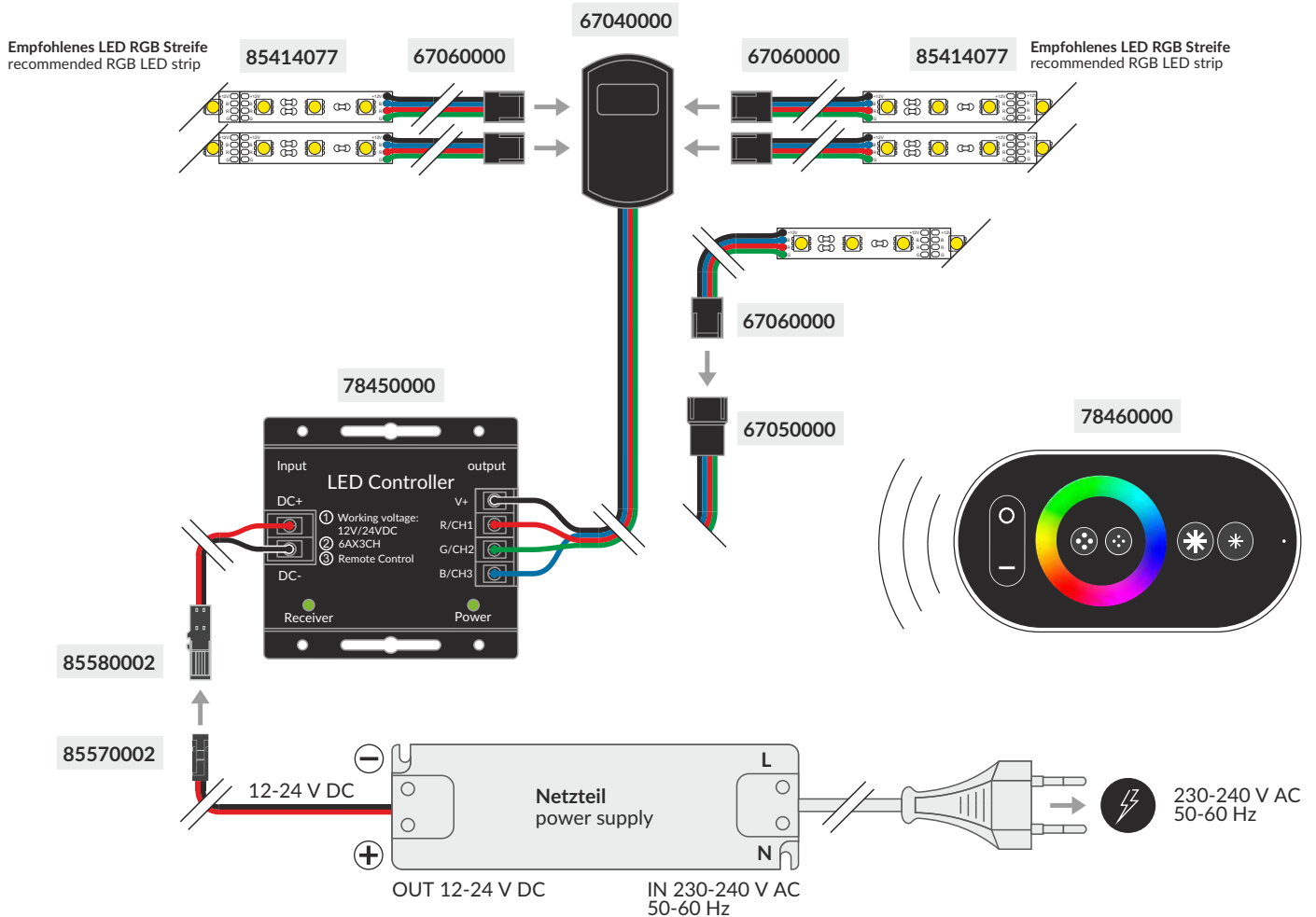

Kabel, Verlängerungskabel, Anschlüsse / cables, extensions, connectors

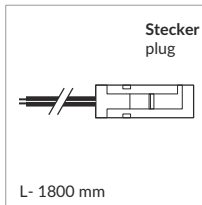

Kabel für LED / LED cable

2x0,35
1800 mm
1xMINI Stecker / 1xMINI plug
schwarz / black

85430002

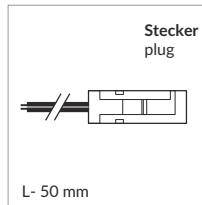

Kabel für LED / LED cable

2x0,35
50 mm
1xMINI Stecker / 1xMINI plug
schwarz / black

85570002

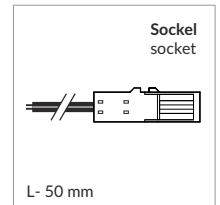

Kabel für LED / LED cable

2x0,35
50 mm
1xMINI Sockel / 1xMINI socket
schwarz / black

85580002

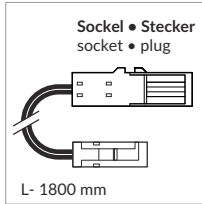

Kabel für LED LED extension cable

2x0,35
1800 mm
1xMINI Sockel / 1xMINI socket
1xMINI Stecker / 1xMINI plug
schwarz / black

85460002

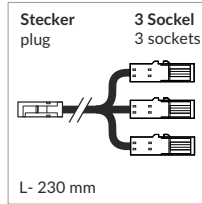

LED Verteiler / LED cable

2x0,35
230 mm
3xMINI Sockel / 3xMINI socket
1xMINI Stecker / 1xMINI plug
schwarz / black

85470002

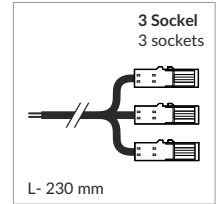

LED Verteiler / LED cable

2x0,35
230 mm
3xMINI Sockel / 3xMINI socket
schwarz / black

85590002

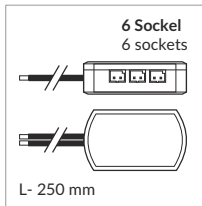

LED integrierter Verteiler LED distribution box

2x0,5
250 mm
6xMINI Sockel / 6xMINI socket
schwarz / black

85366900

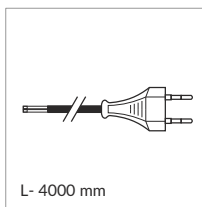

Kable / cable

250 V
2x0,75
4000 mm
1xStecker / 1xPlug
schwarz / black
2,5 A

67100002

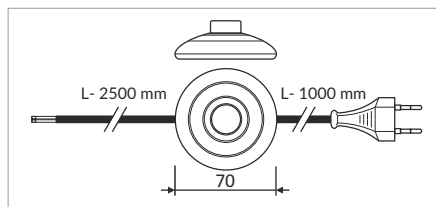

Kabel mit Fußschalter / cable with footswitch

250 V
2x0,75
1000/2500 mm
1xStecker / 1xPlug
schwarz / black
2,5 A

67110002

Abhängungen für die LED Profile / LED profile slings

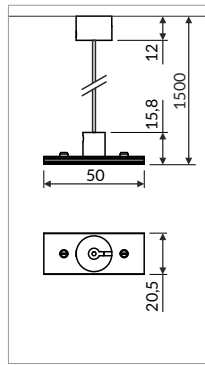

Abhängung SELV

SELV sling
50 V; 1500

weiß	silbern	schwarz
white	silver	black
67120001	67120022	67120002

Artikelnummer = 1 Set = 2 Stück, Verpackung > siehe bitte Preisliste
INDEX = 1 set = 2 pcs, package > check the pricelist

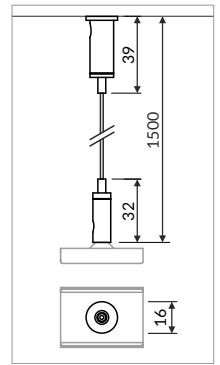

Abhängung für LED Profil-Halter

sling for LED mounting

1500

Chrom
chrome
67140003

Artikelnummer = 1 Set = 2 Stück, Verpackung > siehe bitte Preisliste
INDEX = 1 set = 2 pcs, package > check the pricelist

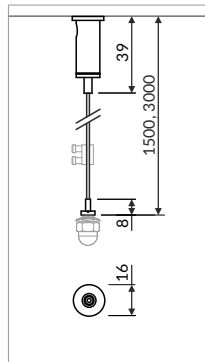

große Abhängung

large sling

Chrom 1500 mm	Chrom 3000 mm
chrome 1500 mm	chrome 3000 mm
43100003	43110003

Artikelnummer = 1 Set = 2 Stück, Verpackung > siehe bitte Preisliste
INDEX = 1 set = 2 pcs, package > check the pricelist

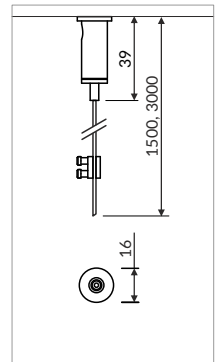

Abhängung SKB

SKB sling

Chrom 1500 mm	Chrom 3000 mm
chrome 1500 mm	chromee 3000 mm
67160003	67170003

Artikelnummer = 1 Set = 1 Stück, Verpackung > siehe bitte Preisliste
INDEX = 1 set = 1 pc, package > check the pricelist

Gelenkhalter für die LED Profile / tilted bracket for LED profiles

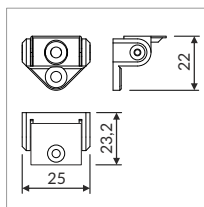

kompatibel mit den flexiblen Halter cone:

U4, U6, U, W, Y, Z
der Satz beinhaltet keine Halter

compatible with cone flexible mounting plates:
U4, U6, U, W, Y, Z
mounting plates not included

Gelenkhalter

tilted bracket

weiß	silbern	schwarz	grau
white	silver	black	grey
67230001	67230040	67230002	67230022

Artikelnummer = 10 Sets = 20 Stück, Verpackung > siehe bitte Preisliste
INDEX = 10 sets = 20 pcs, package > check the pricelist

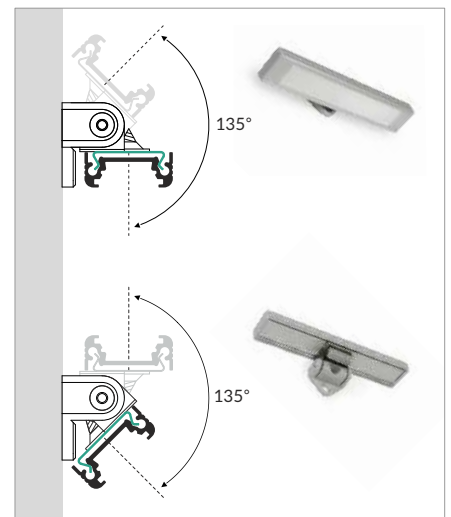

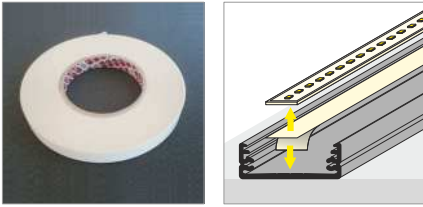

doppelseitiges leitendes Montageband
adhesive tape double-sided thermally conductive

15 mm x 50 m

67990000

1 Rolle / 1 reel

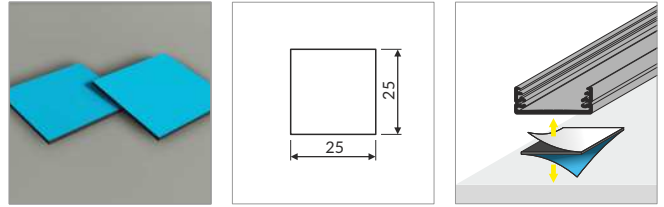

doppelseitiges, nicht leitendes Montageband
adhesive tape double-sided nonconductive

25 x 25 mm

76340000



Silikonhülle für LED Streifen mit 8 mm
silicone housing for 8 mm LED strip

11 mm x 5 mm x 5 m

67980000

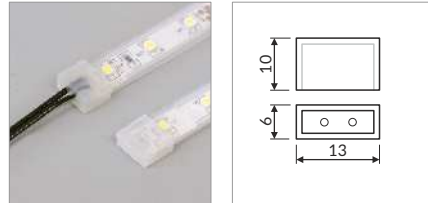

Endkappe für die Silikonhülle für LED Streifen mit 8 mm
ending for silicone housing for 8 mm LED strip

67970000s

Artikelnummer = 1 Set, Verpackung > siehe bitte Preisliste
INDEX = 1 set, package > check the pricelist



der Gummi zur Reinigung der eloxierten Oberflächen
cleaning rubber for anodized surfaces

25250000

2020

LED PROFILE
LED PROFILES

Warum LED Profile? / Why LED profiles?

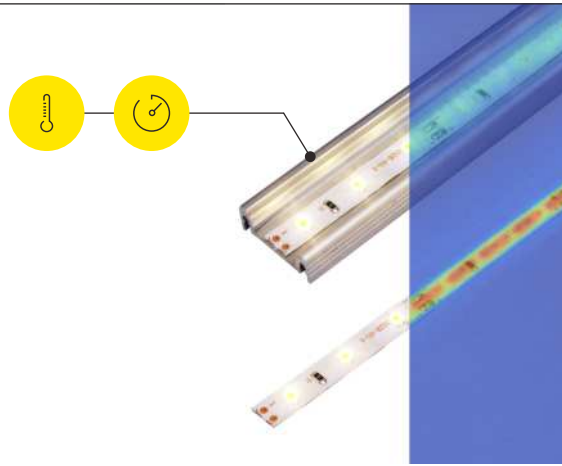

WÄRMEABFUHR

Das LED Profil ist ein Radiator - es strahlt die Wärme aus der LED Lichtquelle ab. Eine niedrigere Temperatur bedeutet bessere Arbeitsbedingungen für die LEDs, was Einfluss auf ihre Lebensdauer nimmt und bessere Lichtparameter sichert. Dies nimmt auch einen Einfluss auf den ökonomischen Aspekt, denn LED Lichtquellen müssen nicht so oft getauscht werden. Das LED Aluminiumprofil ist eine Investition, die sich lohnt.



Einige auf dem Markt zugängliche LED Lichtquellen, können die Wärmeabfuhrmöglichkeiten des gewählten Aluminiumprofils überschreiten. Damit das LED Profil richtig funktioniert, soll man eine LED Lichtquelle mit entsprechenden Lichtparametern wählen.

HEAT DISSIPATION

An aluminium profile is a radiator - it dissipates heat from the LED source. Lower temperature means better operating conditions for the diodes, therefore, extension of the LED lifespan and better illumination parameters. It also translates to economic considerations - LED does not require such frequent replacement of light sources. An aluminium profile is an investment, which pays off.



Some LED sources available on the market may exceed radiation capabilities of a given aluminium profile. In order to ensure correct operation, a LED source with appropriate parameters needs to be matched to an aluminium profile.



ÄSTHETIK / SCHUTZ DES LED STREIFENS

Das LED Aluminiumprofil bildet eine Art Schutz der LED Lichtquelle vor mechanischen Beschädigungen. Die Montage ist viel fester im Vergleich zur Montage der LED Streifen direkt an die Oberfläche. Das Anwenden von einem LED Profil erhöht die ästhetische Seite und sorgt für Sauberhaltung.

AESTHETICS / STRIP PROTECTION

An aluminium profile is a protection for a LED source against mechanical damage. The assembly is much more durable in comparison to gluing a LED strip directly to the surface. Using a profile increases aesthetics and facilitates maintaining cleanliness.



ELOXIERTE BESCHÜTTUNG / FARBVERSIONEN

TOPMET bietet standardmäßig die LED Profile in vier Ausführungen:

Weiß lackiert - pulverbeschichtet, eloxiertes Aluminium in silbern, eloxiertes Aluminium in schwarz, Rohaluminium - kostengünstige Variante, schadensanfällig.

Am meisten wird die eloxierte Version, mit einem hohen Grad der Beständigkeit gegen Kratzer angewendet. Die Dicke des Eloxals auf allen unseren Profilen liegt bei ca. 15 µm.

ANODIZED COATING / COLOUR VERSIONS

In the standard TOPMET offer, aluminium LED profiles are available in 4 basic finishes:

white painted - powder coated, anodised aluminium in silver colour, anodised aluminium in black colour, raw aluminium - economic version, not resistant to damage.

The most eagerly used ones are the anodized versions with a high degree of scratch resistance.

The thickness of the anodic coating on all our profiles is about 15 µm.



ZUBEHÖR

Unsere Projektabteilung arbeitet ständig an der Erweiterung des Angebotes um weitere Komponenten, die die Montage vereinfachen und die Kombinations-, Verbindungs- und Montagemöglichkeiten vervielfachen.

Außer den Haltern, die mit mehreren Profilen kompatibel sind, haben viele Typen der Profile auch eigene Lösungen für mehr fortgeschrittene, spezielle Bedürfnisse. Unter den Zubehörteilen für LED Profile gibt es u.a. Endkappen, Abdeckungen, Halter, Ausleger, Verbinder, Klemmen, Abhängungen und viele andere.

ACCESSORIES

The design department is constantly working on expanding the offer with further components, which facilitate the assembly and multiply the possibilities of combinations, connections and assembly.

Apart from system mounting plates, which match different profiles, many collections also have dedicated solutions for more advanced, specialist needs. The accessories for LED profiles include, i.a.: endings, covers, mounting plates, holders, extension arms, connectors, clamps, slings and many more.



EU Industriedesign
EU-registered industrial design



PL
Hergestellt in Polen
Made in Poland

ENTWURF / FERTIGUNG

Alle Profile sind einzigartig - entwickelt von TOPMET Designer.
Alle Modelle sind registriert worden - gesetzlich geschützt in ganz Europa.
Die Profile, das Zubehör und die Leuchten von TOPMET sind in Polen hergestellt.

DESING / PRODUCTION

All profiles are unique - designed by TOPMET designers.
All the designs are registered - legally protected throughout the European Union.
TOPMET profiles, accessories and luminaires are manufactured in Poland.

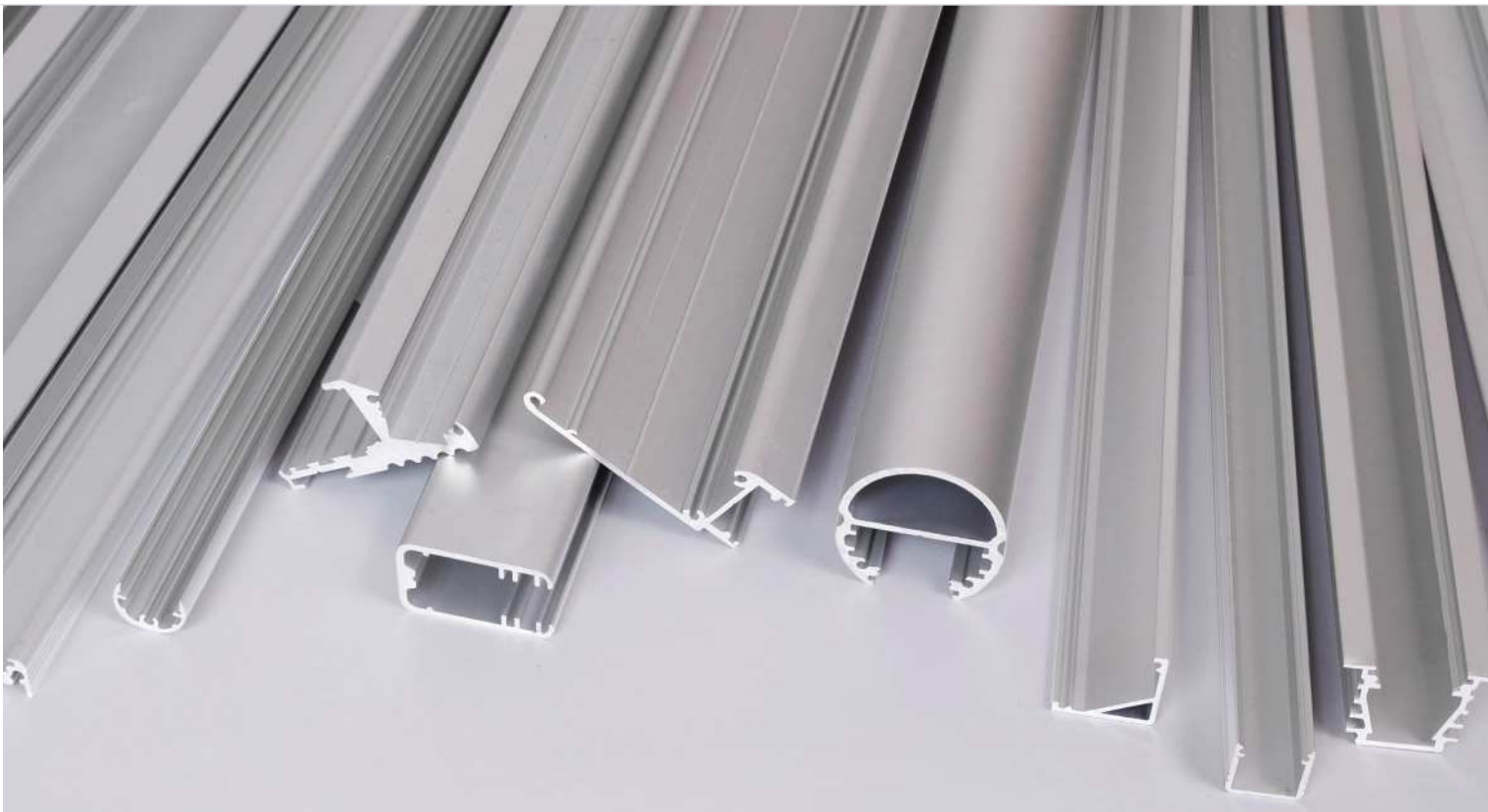

Warum lohnt es sich die LED Technologie zu wählen? Why is it worth to choose LED technology?

ÖKONOMIE / ECONOMY

Vergleich der Lichtquellen mit einem ähnlichen Wert des Lichtstroms / Comparison of light sources of similar lumen output



traditionelle Glühbirne
traditional bulb

Leistung / power: 100 W
Price / price: 0,78 €



Halogen Glühbirne
halogen source

Leistung / power: 70 W
Price / price: 1,19 €



LED Lichtquelle
LED source

Leistung / power: 11,5 W
Price / price: 9,50 €

Energie / Energy

Die notwendige Wattzahl für das Erreichen von Lichtstrom von 1000 lm / Watts necessary to obtain lumen output of 1000 lm

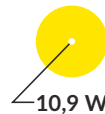
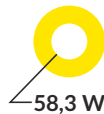
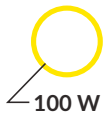

Lebensdauer / Lifespan

Die in Stunden angegebene Zeit, in der eine Glühbirne leuchten wird, bevor sich der Wert des Lichtstroms um 20 - 30 % im Vergleich zu dem Anfangswert verkleinert
Time in hours for which one light source will glow until the lumen output decreases by 20 - 30% compared to the initial value



Ausgaben / Expenses

Die Zahl und die Kosten der abgenutzten Lichtquellen während der Lebensdauer eines LEDs / Amount and costs of worn-out light sources during one LED source lifespan



Die Energiekosten von einem Tag, wenn das Licht 8 Stunden lang eingeschaltet bleibt* / Daily costs of energy if the light glows for 8h*

0,11 €

0,07 €

0,01 €

Die Energiekosten während der ganzen Lebensdauer der LED Lichtquelle* / Costs of energy throughout the LED source lifespan*

203,58 €

142,50 €

23,41 €

Gesamtkosten / Total cost

der Nutzung und des Preises der Lichtquelle** / of operation and light source prices**

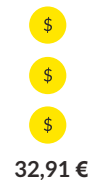
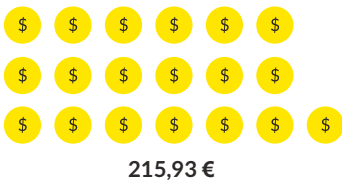

Wie viel kann man sparen, wenn man LED Lichtquelle verwendet? / How much can you save by using a LED light source?



Im Vergleich zu einer traditionellen Glühbirne
In relation to traditional bulb

183,01 €



Im Vergleich zu einer Halogen Glühbirne
In relation to halogen source

118,55 €

*bei der Annahme eines Satzes von 0,14 € pro 1 kWh / assuming the rate per 1 kWh at a level of: 0,14 €
**In der ganzen Lebensdauer einer LED Lichtquelle / throughout the LED source lifespan

ÖKOLOGIE / EKOLOGY



Das, worauf wir besonders unsere Aufmerksamkeit lenken sollen, ist die Auswirkung der Alltagsgeräte auf unsere natürliche Umwelt. Die Leuchten mit LED Technologie sind biologisch abbaubar, haben eine längere Lebensdauer im Vergleich zu traditionellen Lichtquellen und verbrauchen weniger Energie. Überdies beinhalten LEDs kein Quecksilber.

Weniger Austausch von Lichtquellen = weniger Abfall in unserer Umwelt

What we should pay particular attention to is the impact of everyday use devices on the natural environment.

And so, lights using the LED technology are biodegradable, have a longer lifespan compared to traditional sources and consume less energy. Moreover, LED does not contain mercury.

less source replacements = less waste reaching the environment





2020

LED PROFILE
LED PROFILES

Verkaufsunterstützung / Sales support

LED PROFILES SAMPLE BOX



LED PROFILES SAMPLE CASE



LED PROFILES SAMPLE BOARD



LED Profile / LED profiles



VARIO30



große Profile / big profiles



LED PROFILES DISPLAY STAND

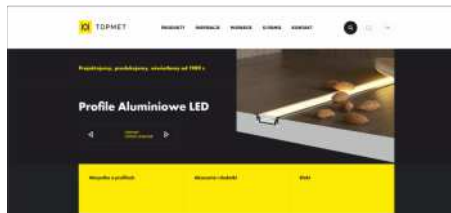

www.topmet.pl/en



LED Profile Sets
LED profile sets



Die Katalogkarten mit den LED Leuchten
LED luminaires catalogues



Professionelle Beratung
Professional consultancy service

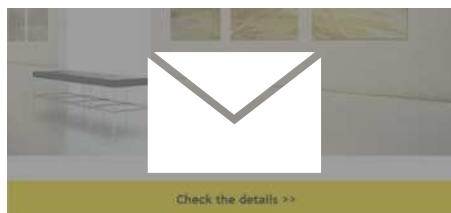

Newsletter



Bilder
Photos

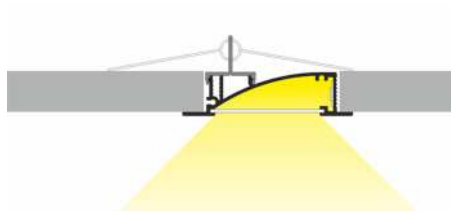

Graphiken
Graphics



Wir laden Sie zur Prüfung unserer social media ein.
We encourage to follow our social media accounts.

Die allgemeinen Garantiebedingungen sind auf der Internetseite zugänglich:
<http://www.topmet.pl/en/tc/>

General terms and conditions eavailable on website: <http://www.topmet.pl/en/tc/>

Siehe auch / See also

